

EXAKT

MFG CO

SURGICAL INSTRUMENTS



ORIGINAL
INSTRUMENTS
MANUFACTURER

ORIGINAL
BRAND
MANUFACTURER

www.exaktmfgco.com



ABOUT US

GLH Inc. was established 1992 as a consulting and service organization. Our Founders have more than 60 years active experience in the medical field.

Our products come from the leading surgical instrument manufactures located in the Medical Valley of Tuttlingen Germany. Tuttlingen is known as the „Surgical Instrument Capitol of the World“.

GLH Inc. has a long tradition of working with manufactures and leading surgeons in close collaboration, consistently develop and refine better instruments. We combine both tradition and innovation in our pursuit of excellence.

Our products utilizes the newest manufacturing methods and are built with the skilled hands and trained eyes of highly qualified craftsmen to produce instruments that exceed our quality standards. We are proud to state that our instruments are „Made in germany“.

To ensure the highest level of quality, our products are subject to a number of regulations such as DIN/ISO 9001, ISO 13485 and the FDA Good Manufacturing Practices. These standarts are applied to all stages of the design, development and manufacturing process.

Our goal is to deliver superior surgical instruments as well as professional and efficient repair solutions to our customers.

GLH Inc. Management

Sterile Skalpellslingen, Skalpellsgriffe
Sterile Scalpel Blades, Scalpel Handles
Hojas de bisturíes estériles, Mangos de bisturíes
Lame per bisturi sterili, Manici per bisturi



No. 3
13,0 cm, 5"
003-003-00



No. 3
13,0 cm, 5"
003-003-01



No. 3L
21,0 cm, 8¼"
003-003-02



No. 7
16,5 cm, 6½"
003-007-00



No. 7K
13,0 cm, 5"
003-007-01



No. 4
13,5 cm, 5³/₈"
003-004-00



No. 4L
21,0 cm, 8³/₈"
003-004-01



No. 8
13,5 cm, 5³/₈"
003-008-00



No. 9
14,5 cm, 5³/₄"
003-009-00

Einmal-Skalpelle, steril
Disposable Scalpels, sterile
Bisturios para uso único, estériles
Bisturi monouso, sterili



Fig. 10
003-050-10



Fig. 11
003-050-11



Fig. 11s
003-050-11S



Fig. 12
003-050-12



Fig. 12d
003-050-12D



Fig. 13
003-050-13



Fig. 15
003-050-15



Fig. 15c
003-050-15C



Fig. 18
003-050-18



Fig. 19
003-050-19



Fig. 20
003-050-20



Fig. 21
003-050-21



Fig. 22
003-050-22



Fig. 23
003-050-23



Fig. 24
003-050-24



Fig. 1 003-066-01
Fig. 2 003-066-02
Fig. 3 003-066-03



OPERATION
17,0 cm, 6¾"

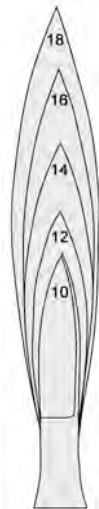


Fig. 10 003-060-10
Fig. 12 003-060-12
Fig. 14 003-060-14
Fig. 16 003-060-16
Fig. 18 003-060-18



COLLIN
16,0 cm, 6¼"



Fig. 4 003-066-04
Fig. 5 003-066-05
Fig. 6 003-066-06



Fig. 1 **003-070-01**
Fig. 2 **003-070-02**
Fig. 3 **003-070-03**
Fig. 4 **003-070-04**
Fig. 5 **003-070-05**



Fig. 1 **003-076-01**
Fig. 2 **003-076-02**
Fig. 3 **003-076-03**
Fig. 4 **003-076-04**
Fig. 5 **003-076-05**



Fig. 15 **003-078-15**



DISSECTING
17,0 cm, 6¾"



Fig. 6 **003-070-06**
Fig. 7 **003-070-07**
Fig. 8 **003-070-08**
Fig. 9 **003-070-09**
Fig. 10 **003-070-10**



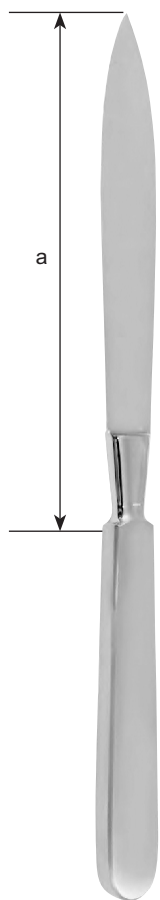
DIEFENBACH
16,0 cm, 6¼"



Fig. 6 **003-076-06**
Fig. 7 **003-076-07**
Fig. 8 **003-076-08**
Fig. 9 **003-076-09**

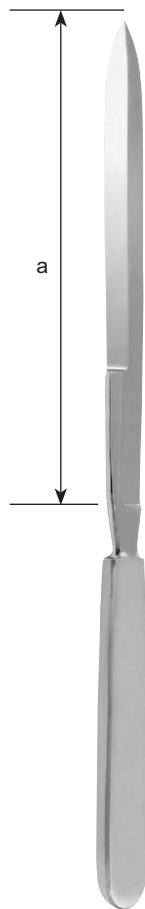


Fig. 16 **003-078-16**



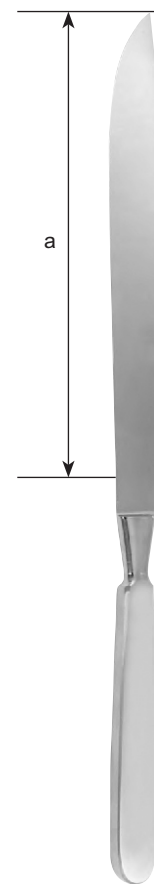
COLLIN

a	
13,0 cm, 5"	003-080-13
16,0 cm, 6 ¹ / ₄ "	003-080-16
19,0 cm, 7 ¹ / ₂ "	003-080-19
22,0 cm, 8 ⁵ / ₈ "	003-080-22
28,0 cm, 11"	003-080-28



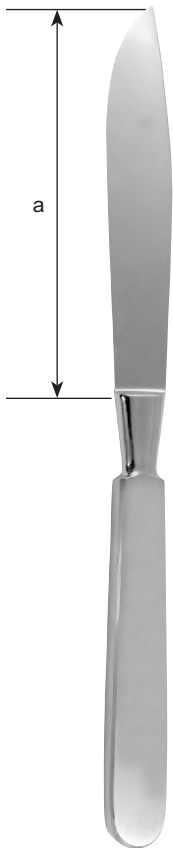
CATLIN

A	
16,0 cm, 6 ¹ / ₄ "	003-082-16
19,0 cm, 7 ¹ / ₂ "	003-082-19
22,0 cm, 8 ⁵ / ₈ "	003-082-22

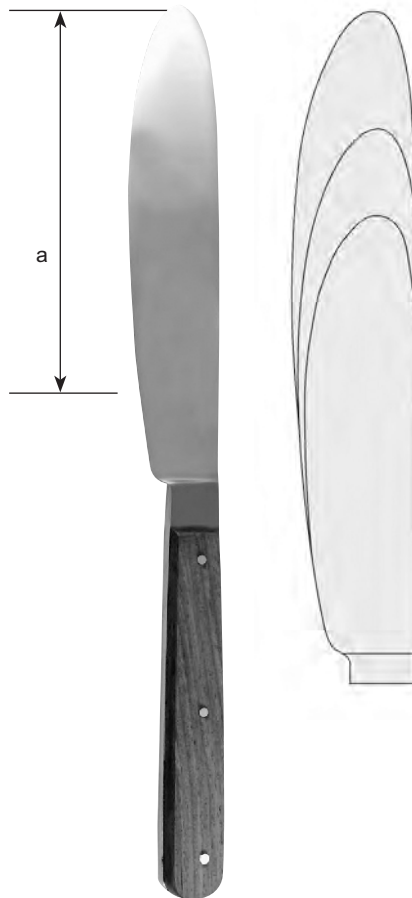


LISTON

A	
17,0 cm, 6 ³ / ₄ "	003-250-17
20,0 cm, 8"	003-250-20
22,0 cm, 8 ⁵ / ₈ "	003-250-22

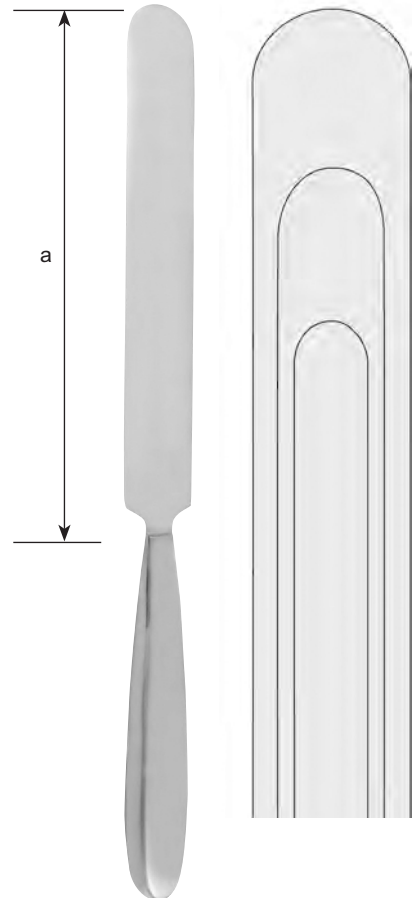


LANGENBECK
 003-280-12



WALB

A	
11,0 cm, 4 1/2"	003-150-11
14,0 cm, 5 1/2"	003-150-14
17,0 cm, 6 3/4"	003-150-17



VIRCHOW

A	
16,0 cm, 6 1/4"	003-180-16
20,0 cm, 8"	003-180-20
24,0 cm, 9 1/2"	003-180-24

Amputationsmesser, Dermatomy
Amputation Knives, Dermatomyes
Cuchillos para amputación, Dermátomos
Coltelli per amputazione, Dermatomy



LANGENBECK
18,0 cm, 7"
003-105-55



CARTILAGE
17,5 cm, 6⁵/₈"
003-110-65

mit Schaber
with raspatory
con periostótomo
con raschiatoio

Haut-Spannplatten
Skin straightening plate
Placa para extender la piel
Placca per stendere la pelle



003-422-30

003-401-19
Ersatzklinge
Spare blade
Hoja de repuesto
Lama di ricambio



SILVER
19 cm, 7 1/2"
003-400-19

003-411-30
Ersatzklinge
Spare blade
Hoja de repuesto
Lama di ricambio



BRAITHWAITE
30,0 cm, 12"
003-410-30

003-413-35
Ersatzklinge
Spare blade
Hoja de repuesto
Lama di ricambio

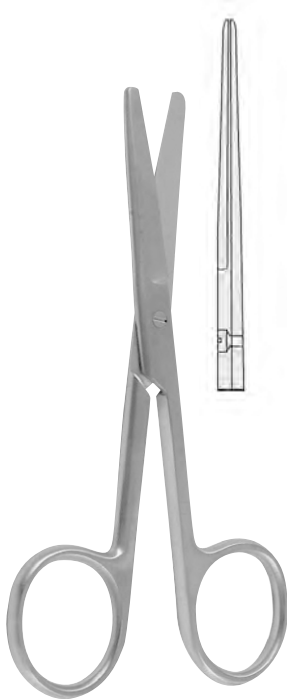


HUMBY
35,0 cm, 14"
003-412-35

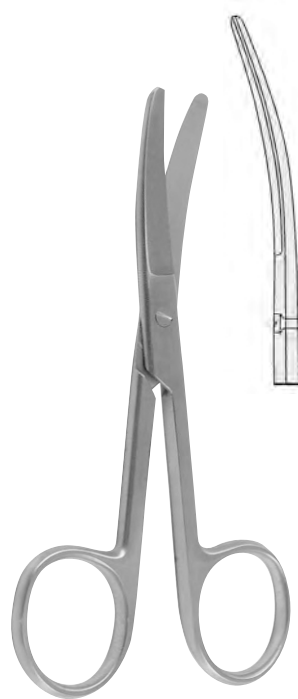
003-421-30
Ersatzklinge
Spare blade
Hoja de repuesto
Lama di ricambio



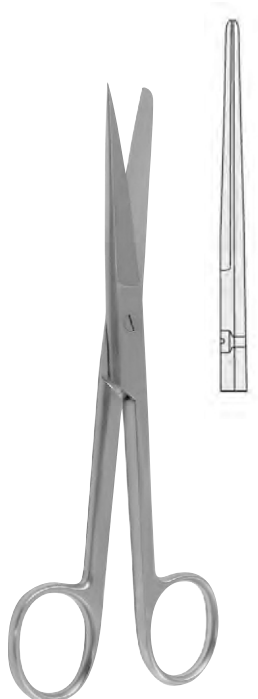
SCHINK
30,0 cm, 12"
003-420-30



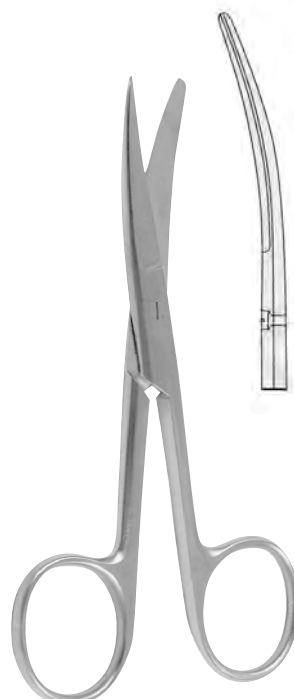
STANDARD	
10,5 cm, 4 ¹ / ₄ "	010-000-10
11,5 cm, 4 ¹ / ₂ "	010-000-11
13,0 cm, 5"	010-000-13
14,5 cm, 5 ³ / ₄ "	010-000-14
15,5 cm, 6"	010-000-15
16,5 cm, 6 ¹ / ₂ "	010-000-16
17,5 cm, 6 ⁵ / ₈ "	010-000-17
18,5 cm, 7 ¹ / ₄ "	010-000-18
20,0 cm, 8"	010-000-20



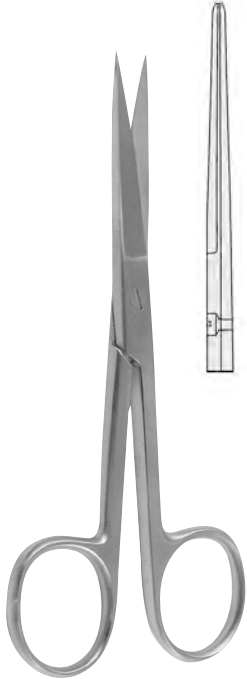
STANDARD	
10,5 cm, 4 ¹ / ₄ "	010-001-10
11,5 cm, 4 ¹ / ₂ "	010-001-11
13,0 cm, 5"	010-001-13
14,5 cm, 5 ³ / ₄ "	010-001-14
15,5 cm, 6"	010-001-15
16,5 cm, 6 ¹ / ₂ "	010-001-16
17,5 cm, 6 ⁵ / ₈ "	010-001-17
18,5 cm, 7 ¹ / ₄ "	010-001-18
20,0 cm, 8"	010-001-20



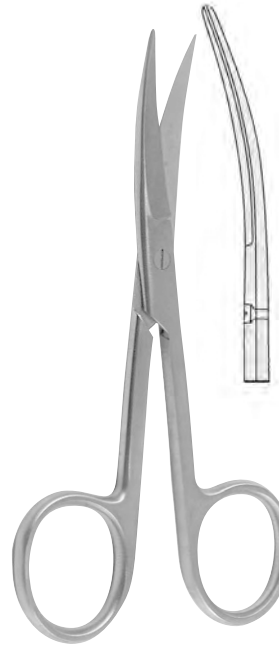
STANDARD	
10,5 cm, 4 ¹ / ₄ "	010-002-10
11,5 cm, 4 ¹ / ₂ "	010-002-11
13,0 cm, 5"	010-002-13
14,5 cm, 5 ³ / ₄ "	010-002-14
15,5 cm, 6"	010-002-15
16,5 cm, 6 ¹ / ₂ "	010-002-16
17,5 cm, 6 ⁵ / ₈ "	010-002-17
18,5 cm, 7 ¹ / ₄ "	010-002-18
20,0 cm, 8"	010-002-20



STANDARD	
10,5 cm, 4 ¹ / ₄ "	010-003-10
11,5 cm, 4 ¹ / ₂ "	010-003-11
13,0 cm, 5"	010-003-13
14,5 cm, 5 ³ / ₄ "	010-003-14
15,5 cm, 6"	010-003-15
16,5 cm, 6 ¹ / ₂ "	010-003-16
17,5 cm, 6 ⁵ / ₈ "	010-003-17
18,5 cm, 7 ¹ / ₄ "	010-003-18
20,0 cm, 8"	010-003-20



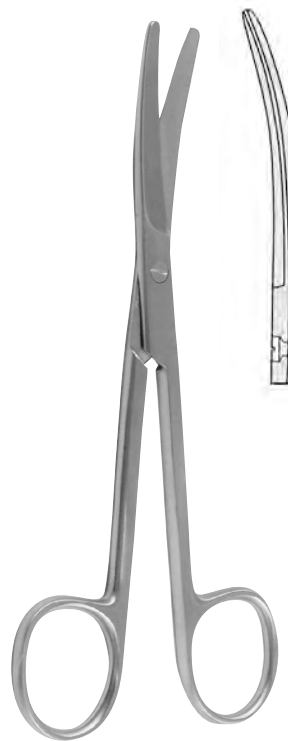
STANDARD	
10,5 cm, 4 ¹ / ₄ "	010-004-10
11,5 cm, 4 ¹ / ₂ "	010-004-11
13,0 cm, 5"	010-004-13
14,5 cm, 5 ³ / ₄ "	010-004-14
15,5 cm, 6"	010-004-15
16,5 cm, 6 ¹ / ₂ "	010-004-16
17,5 cm, 6 ⁵ / ₈ "	010-004-17
18,5 cm, 7 ¹ / ₄ "	010-004-18
20,0 cm, 8"	010-004-20



STANDARD	
10,5 cm, 4 ¹ / ₄ "	010-005-10
11,5 cm, 4 ¹ / ₂ "	010-005-11
13,0 cm, 5"	010-005-13
14,5 cm, 5 ³ / ₄ "	010-005-14
15,5 cm, 6"	010-005-15
16,5 cm, 6 ¹ / ₂ "	010-005-16
17,5 cm, 6 ⁵ / ₈ "	010-005-17
18,5 cm, 7 ¹ / ₄ "	010-005-18
20,0 cm, 8"	010-005-20



DEAVER	
12,0 cm, 4 ³ / ₄ "	010-050-12
13,0 cm, 5"	010-050-13
14,5 cm, 5 ³ / ₄ "	010-050-14



DEAVER	
12,0 cm, 4 ³ / ₄ "	010-051-12
13,0 cm, 5"	010-051-13
14,5 cm, 5 ³ / ₄ "	010-051-14



DEAVER

12,0 cm, 4 ³ / ₄ "	010-052-12
13,0 cm, 5"	010-052-13
14,5 cm, 5 ³ / ₄ "	010-052-14



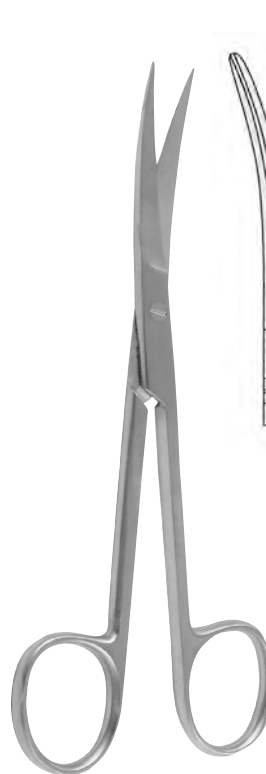
DEAVER

12,0 cm, 4 ³ / ₄ "	010-053-12
13,0 cm, 5"	010-053-13
14,5 cm, 5 ³ / ₄ "	010-053-14



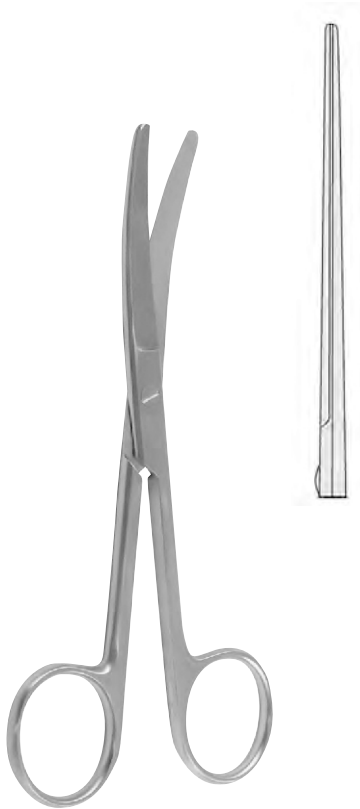
DEAVER

12,0 cm, 4 ³ / ₄ "	010-054-12
13,0 cm, 5"	010-054-13
14,5 cm, 5 ³ / ₄ "	010-054-14

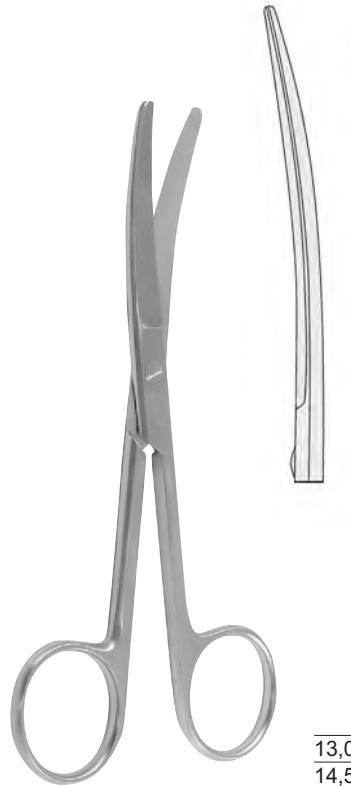


DEAVER

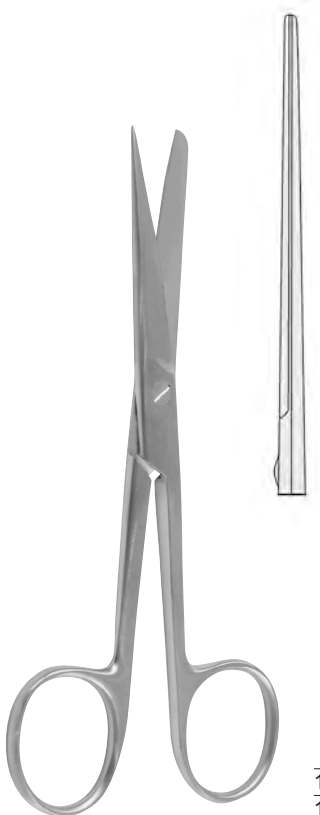
12,0 cm, 4 ³ / ₄ "	010-055-12
13,0 cm, 5"	010-055-13
14,5 cm, 5 ³ / ₄ "	010-055-14



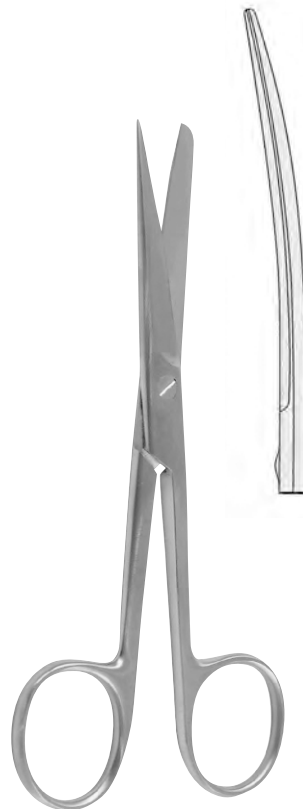
GRAZIL
13,0 cm, 5" **010-070-13**
14,5 cm, 5³/₄" **010-070-14**



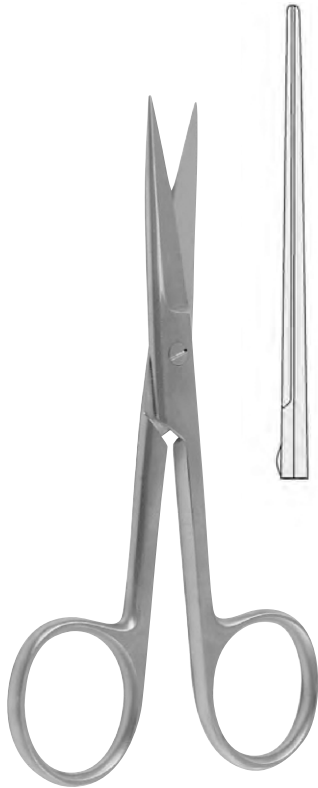
GRAZIL
13,0 cm, 5" **010-071-13**
14,5 cm, 5³/₄" **010-071-14**



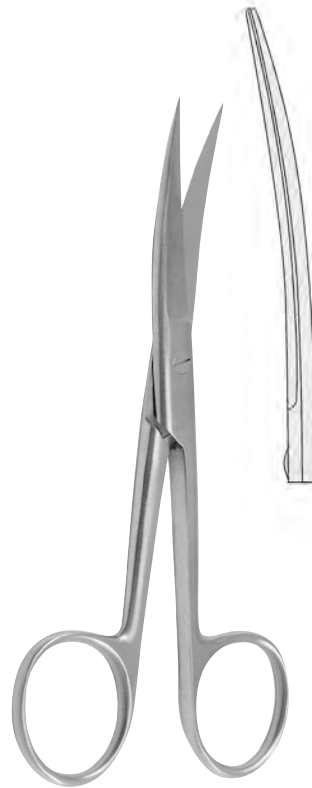
GRAZIL
13,0 cm, 5" **010-072-13**
14,5 cm, 5³/₄" **010-072-14**



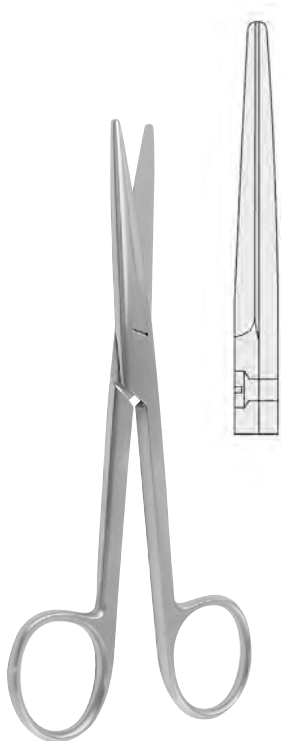
GRAZIL
13,0 cm, 5" **010-073-13**
14,5 cm, 5³/₄" **010-073-14**



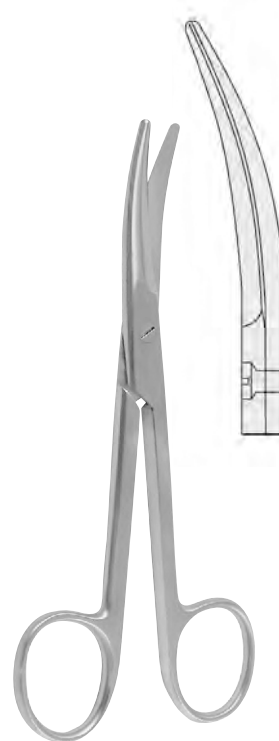
GRAZIL
 13,0 cm, 5" **010-074-13**
 14,5 cm, 5³/₄" **010-074-14**



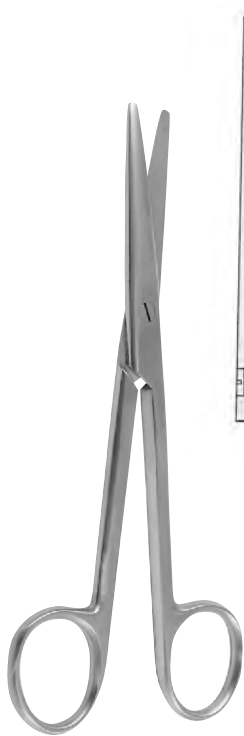
GRAZIL
 13,0 cm, 5" **010-075-13**
 14,5 cm, 5³/₄" **010-075-14**



MAYO
 14,5 cm, 5³/₄" **010-100-14**
 17,0 cm, 6³/₄" **010-100-17**
 23,0 cm, 9" **010-100-23**
 28,0 cm, 11" **010-100-28**



MAYO
 14,5 cm, 5³/₄" **010-101-14**
 17,0 cm, 6³/₄" **010-101-17**
 23,0 cm, 9" **010-101-23**
 28,0 cm, 11" **010-101-28**



MAYO-STILE

15,0 cm, 6"	010-102-15
17,0 cm, 6 ³ / ₄ "	010-102-17
19,5 cm, 7 ³ / ₄ "	010-102-19
21,0 cm, 8 ¹ / ₄ "	010-102-21



MAYO-STILE

15,0 cm, 6"	010-103-15
17,0 cm, 6 ³ / ₄ "	010-103-17
19,5 cm, 7 ³ / ₄ "	010-103-19
21,0 cm, 8 ¹ / ₄ "	010-103-21



010-104-17



010-105-17

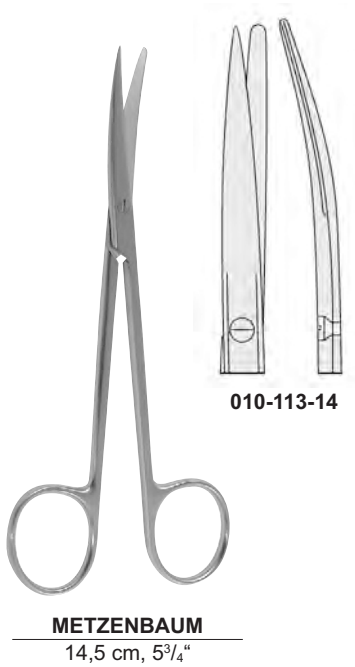
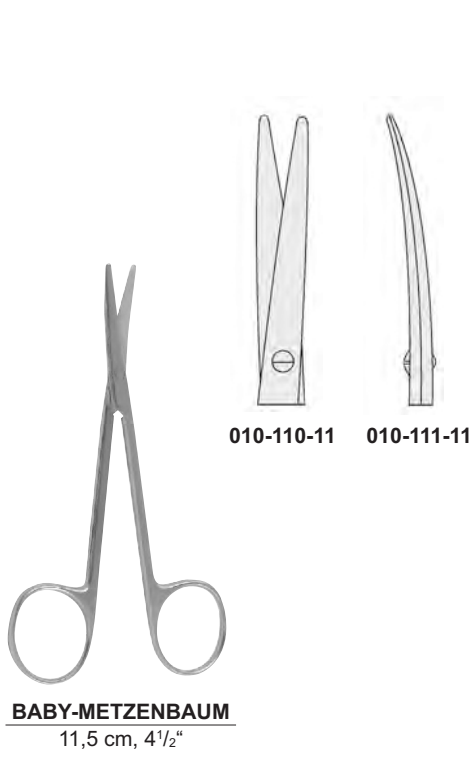
MAYO-NOBLE

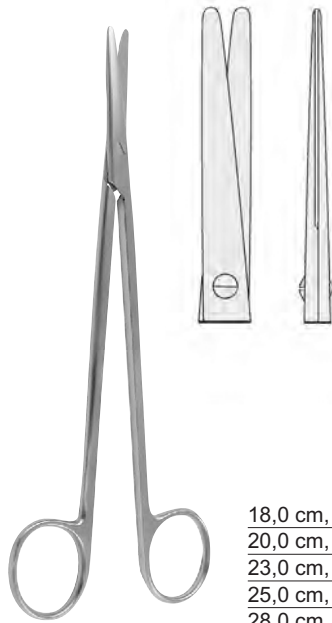
17,0 cm, 6³/₄"



FOMON

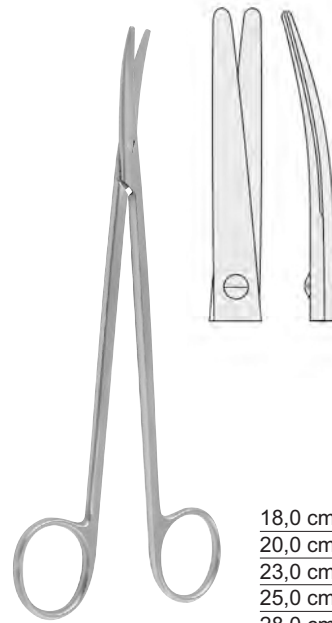
13,5 cm, 5³/₈" **010-009-13**





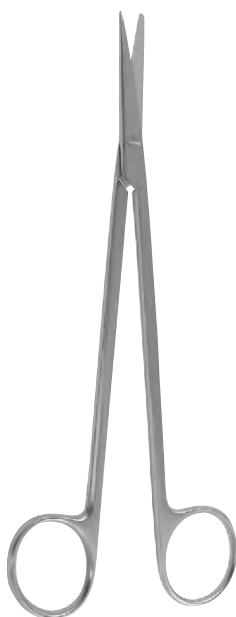
METZENBAUM

18,0 cm, 7"	010-110-18
20,0 cm, 8"	010-110-20
23,0 cm, 9"	010-110-23
25,0 cm, 10"	010-110-25
28,0 cm, 11"	010-110-28
30,0 cm, 12"	010-110-30



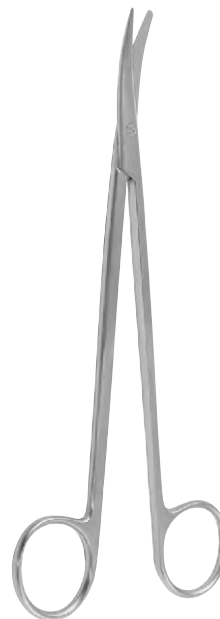
METZENBAUM

18,0 cm, 7"	010-111-18
20,0 cm, 8"	010-111-20
23,0 cm, 9"	010-111-23
25,0 cm, 10"	010-111-25
28,0 cm, 11"	010-111-28
30,0 cm, 12"	010-111-30



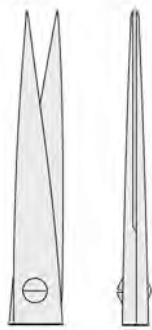
METZENBAUM

18,0 cm, 7"	010-112-18
20,0 cm, 8"	010-112-20
23,0 cm, 9"	010-112-23
25,0 cm, 10"	010-112-25
28,0 cm, 11"	010-112-28
30,0 cm, 12"	010-112-30



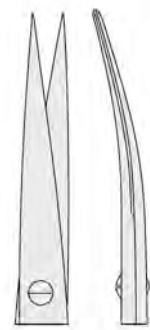
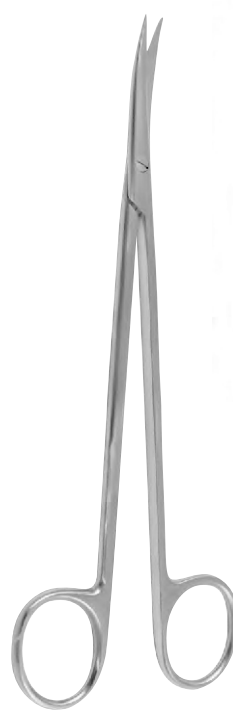
METZENBAUM

18,0 cm, 7"	010-113-18
20,0 cm, 8"	010-113-20
23,0 cm, 9"	010-113-23
25,0 cm, 10"	010-113-25
28,0 cm, 11"	010-113-28
30,0 cm, 12"	010-113-30



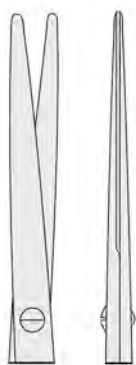
18,0 cm, 7"	010-114-18
20,0 cm, 8"	010-114-20
23,0 cm, 9"	010-114-23
25,0 cm, 10"	010-114-25
28,0 cm, 11"	010-114-28
30,0 cm, 12"	010-114-30

METZENBAUM

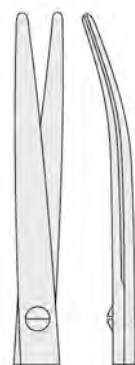


18,0 cm, 7"	010-115-18
20,0 cm, 8"	010-115-20
23,0 cm, 9"	010-115-23
25,0 cm, 10"	010-115-25
28,0 cm, 11"	010-115-28
30,0 cm, 12"	010-115-30

METZENBAUM



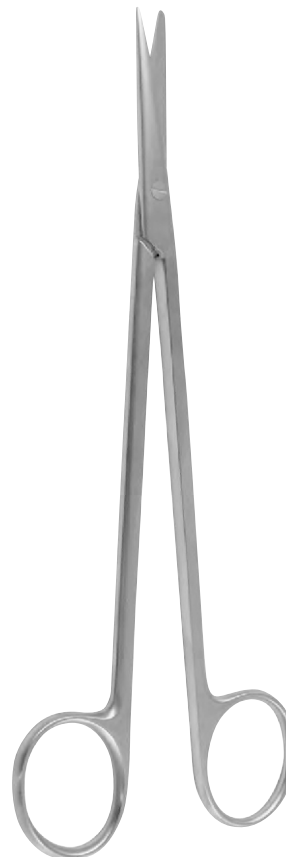
010-120-14



010-121-14

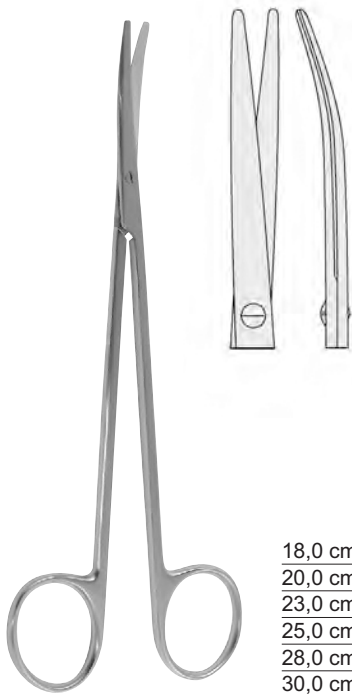
METZENBAUM-FINO

14,5 cm, 5³/₄"



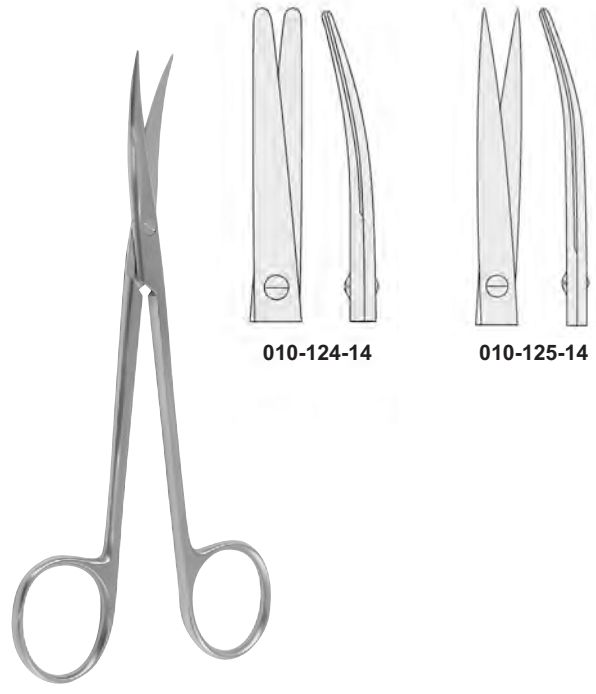
18,0 cm, 7"	010-120-18
20,0 cm, 8"	010-120-20
23,0 cm, 9"	010-120-23
25,0 cm, 10"	010-120-25
28,0 cm, 11"	010-120-28
30,0 cm, 12"	010-120-30

METZENBAUM-FINO



18,0 cm, 7"	010-121-18
20,0 cm, 8"	010-121-20
23,0 cm, 9"	010-121-23
25,0 cm, 10"	010-121-25
28,0 cm, 11"	010-121-28
30,0 cm, 12"	010-121-30

METZENBAUM-FINO



010-124-14

010-125-14

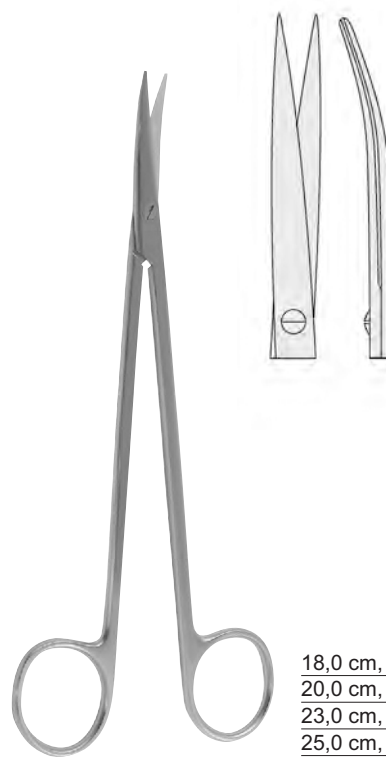
METZENBAUM-FINO

14,5 cm, 5³/₄"



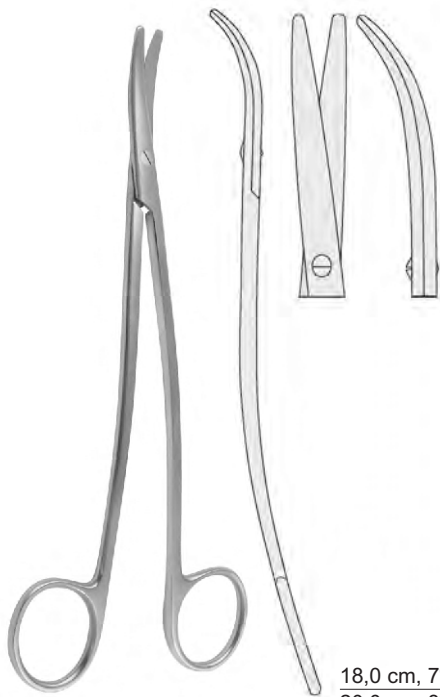
18,0 cm, 7"	010-124-18
20,0 cm, 8"	010-124-20
23,0 cm, 9"	010-124-23
25,0 cm, 10"	010-124-25
28,0 cm, 11"	010-124-28
30,0 cm, 12"	010-124-30

METZENBAUM-FINO



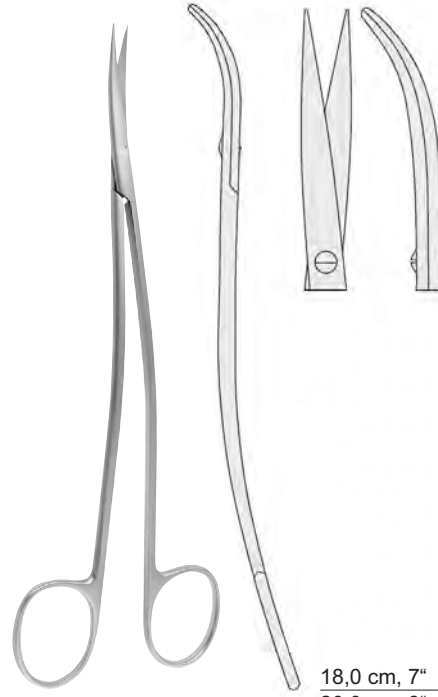
18,0 cm, 7"	010-125-18
20,0 cm, 8"	010-125-20
23,0 cm, 9"	010-125-23
25,0 cm, 10"	010-125-25
28,0 cm, 11"	010-125-28
30,0 cm, 12"	010-125-30

METZENBAUM-FINO



METZENBAUM-FINO S

18,0 cm, 7"	010-127-18
20,0 cm, 8"	010-127-20
23,0 cm, 9"	010-127-23



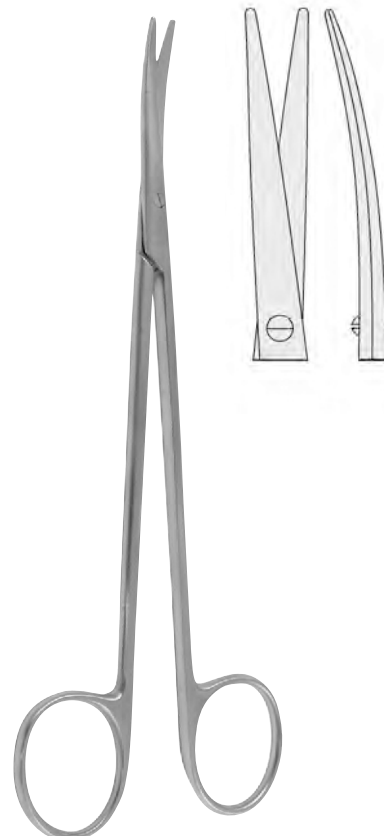
METZENBAUM-FINO S

18,0 cm, 7"	010-129-18
20,0 cm, 8"	010-129-20
23,0 cm, 9"	010-129-23



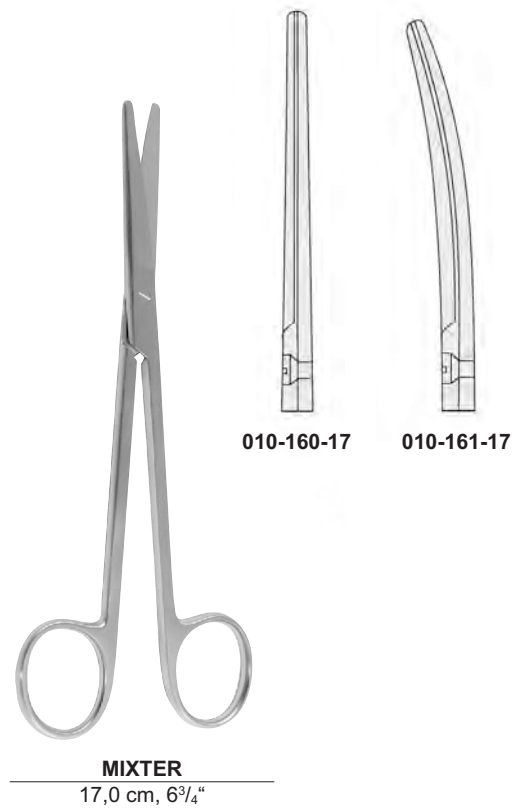
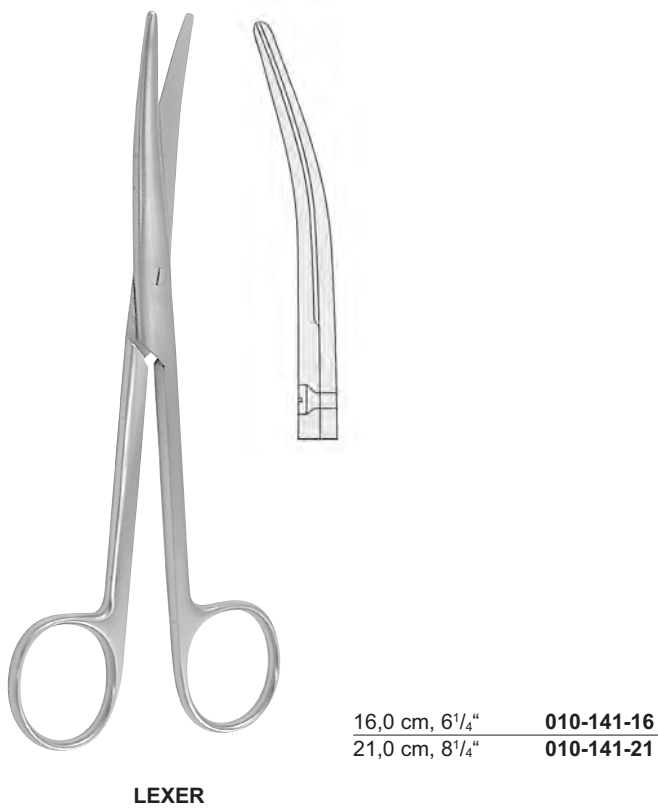
METZENBAUM-LAHEY

14,0 cm, 5 1/2" **010-137-14**

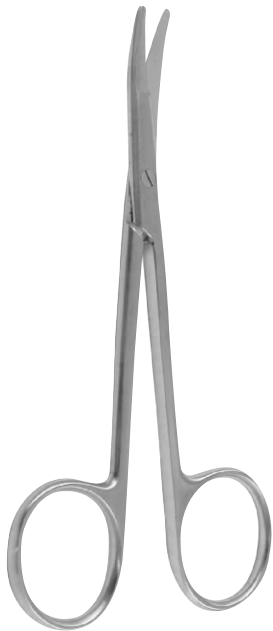


TOENNIS-ADSON

17,0 cm, 6 3/4" **010-139-17**

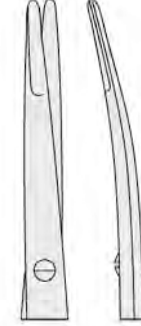


Präparierscheren, feine chirurgische Scheren
 Dissecting Scissors, fine surgical scissors
 Tijeras de disección, tijeras finas para cirugía
 Forbici per dissezione, forbici fine per chirurgia



12,0 cm, 4 ³ / ₄ "	010-200-12
15,0 cm, 6"	010-200-15
18,0 cm, 7"	010-200-18
20,0 cm, 8"	010-200-20

KILNER (RAGNELL)



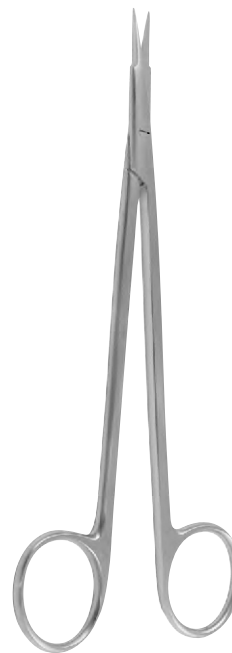
12,0 cm, 4 ³ / ₄ "	010-201-12
15,0 cm, 6"	010-201-15
18,0 cm, 7"	010-201-18
20,0 cm, 8"	010-201-20

KILNER (RAGNELL)



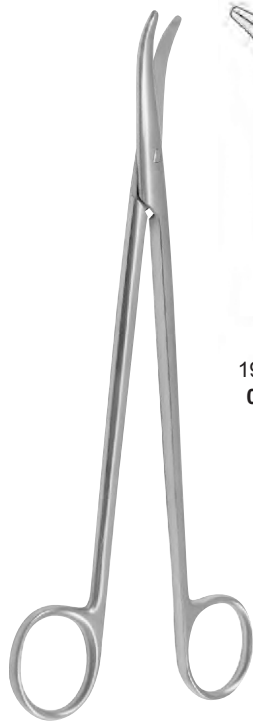
15,0 cm, 6"	010-210-15
18,0 cm, 7"	010-210-18

REYNOLDS

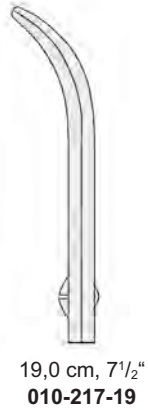


15,0 cm, 6"	010-211-15
18,0 cm, 7"	010-211-18
20,0 cm, 8"	010-211-20
23,0 cm, 9"	010-211-23
25,0 cm, 10"	010-211-25

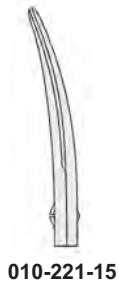
REYNOLDS



THOREK



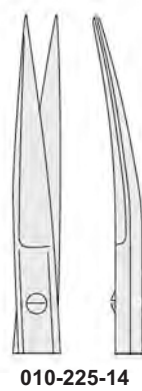
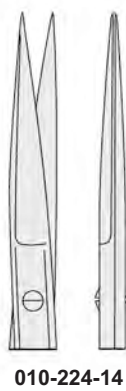
15,0 cm, 6"



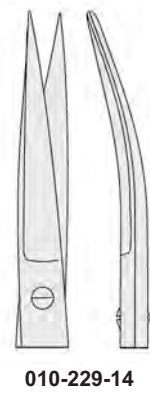
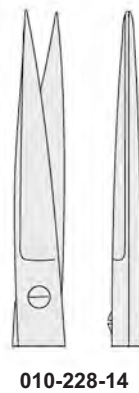
Nerv-Präparierscheren
Nerve dissecting scissors
Tijeras para nervios
Forbici per dissezione di nervi

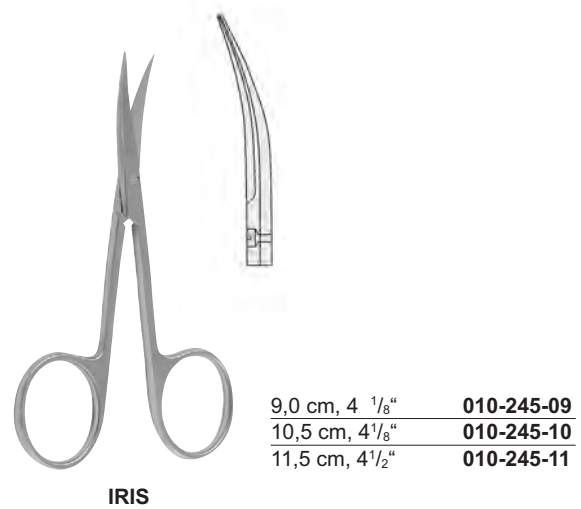
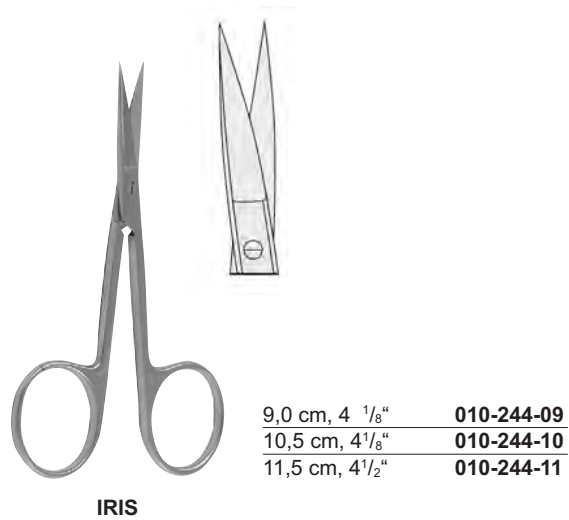


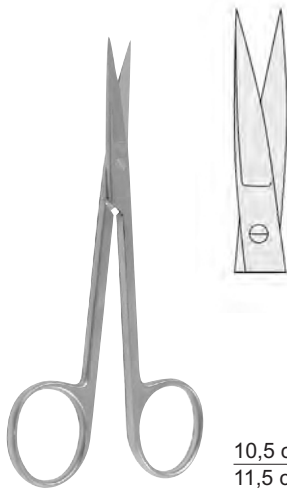
SANVENERO
14,0 cm, 5 1/2"



JOSEPH
14,0 cm, 5 1/2"







10,5 cm, 4¹/₈" **010-250-10**
11,5 cm, 4¹/₂" **010-250-11**

IRIS



10,5 cm, 4¹/₈" **010-251-10**
11,5 cm, 4¹/₂" **010-251-11**

IRIS



11,5 cm, 4¹/₂"
010-261-11



11,5 cm, 4¹/₂"
010-263-11



12,0 cm, 4³/₄"



010-264-12



010-265-12



MOD. BONN
8,0 cm, 3¹/₄"
010-270-08

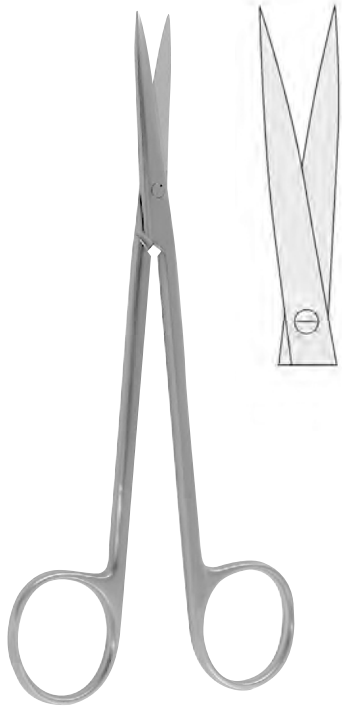


MOD. BONN
8,0 cm, 3¹/₄"
010-271-08

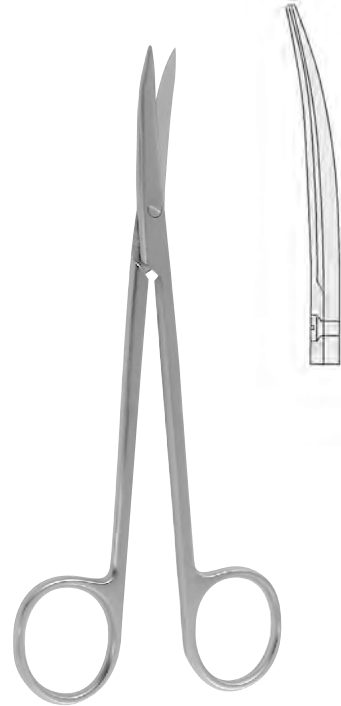


MOD. BONN
8,0 cm, 3¹/₄"
010-273-08





BROPHY (SULLIVAN)
14,0 cm, 5 1/2"
010-276-14

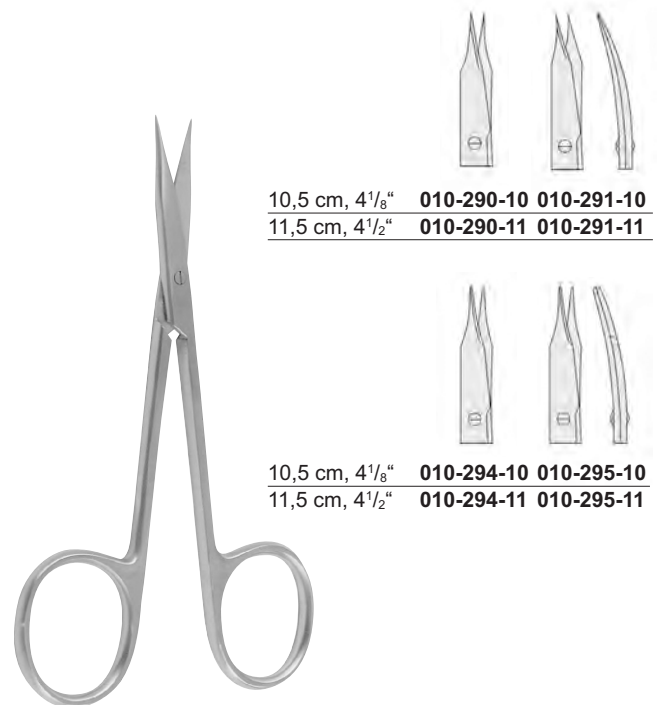


BROPHY (SULLIVAN)
14,0 cm, 5 1/2"
010-277-14



LANDOLT
12,5 cm, 5"

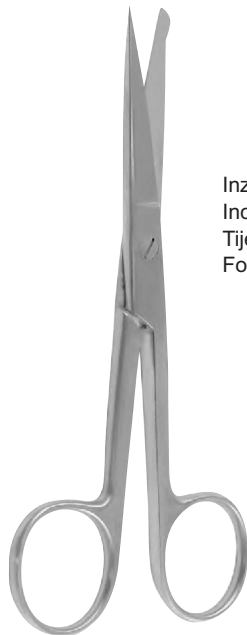
010-280-12 010-283-12 010-285-12



STEVENS

10,5 cm, 4 1/8" 010-290-10 010-291-10
11,5 cm, 4 1/2" 010-290-11 010-291-11

10,5 cm, 4 1/8" 010-294-10 010-295-10
11,5 cm, 4 1/2" 010-294-11 010-295-11



Inzisionsscheren
Incision scissors
Tijeras para incisión
Forbici vascolare e per fistole

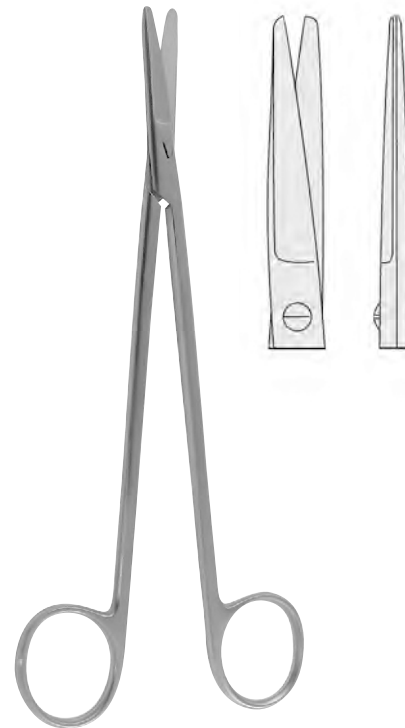
13,0 cm, 5" **010-300-13**
14,5 cm, 5³/₄" **010-300-14**



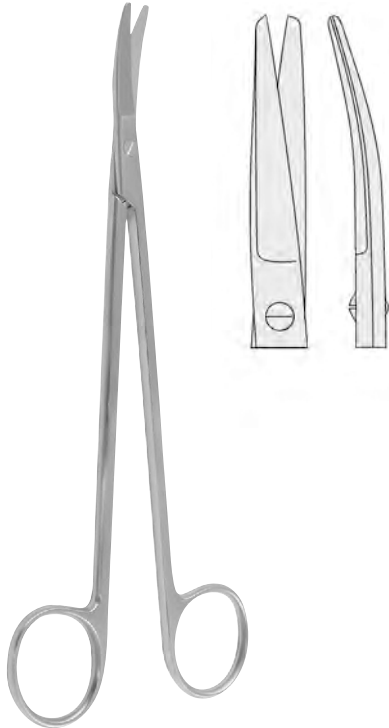
RICHTER
14,5 cm, 5³/₄"
010-310-14



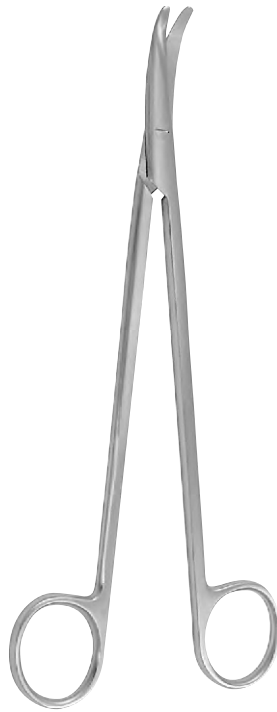
FERGUSON
16,5 cm, 6¹/₄" **010-315-16**
18,0 cm, 7" **010-315-18**



TOENNIS
18,0 cm, 7"
010-324-18



TOENNIS
18,0 cm, 7"
010-325-18



HALLE
19,0 cm, 7 1/2"
010-341-19



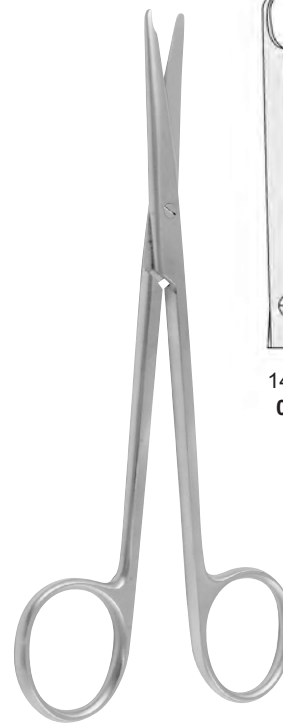
FOMON
15,0 cm, 6"
010-343-15



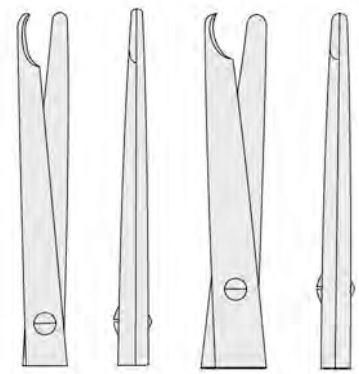
SPENCER
9,0 cm, 4 1/8" **010-400-09**
10,5 cm, 4 1/8" **010-400-10**
13,0 cm, 5" **010-400-13**



LITTAUER
11,5 cm, 4 1/4" **010-402-11**
14,0 cm, 5 1/2" **010-402-14**

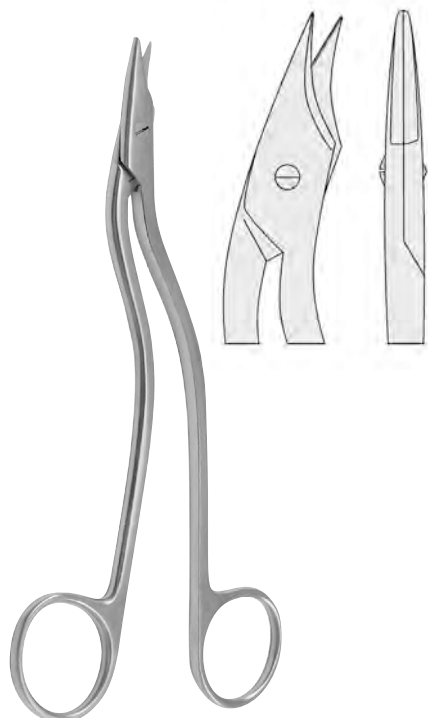


BUCK



14,5 cm, 5 3/4"
010-404-14

18,0 cm, 7"
010-404-18



HEATH
 16,0 cm, 6¼"
 010-408-16



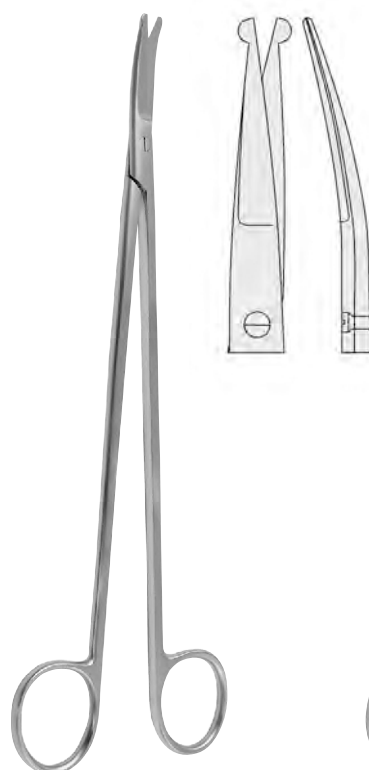
NORTHBENT
 9,0 cm, 3½"
 010-411-19



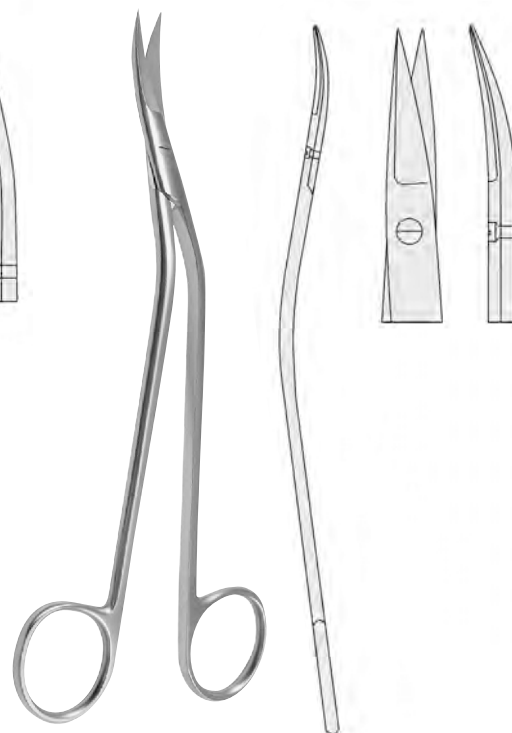
NORTHBENT
 13,0 cm, 5"
 010-413-13



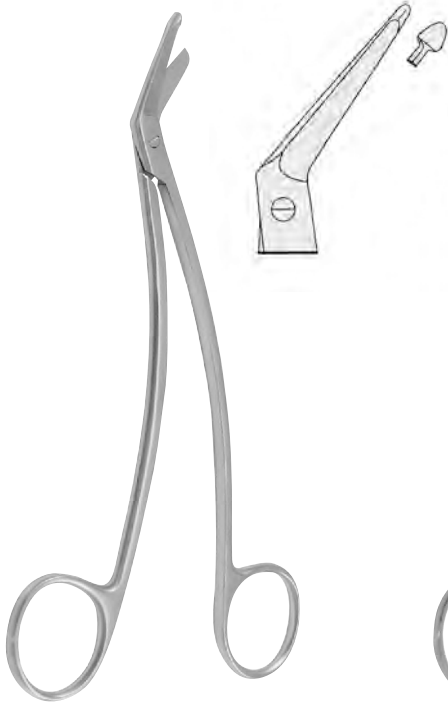
EISELSBERG
 12,0 cm, 4¾"
 010-415-12



STRULLY
 22,0 cm, 8⅝"
 010-450-22



DANDY
 17,0 cm, 6¾"
 010-453-17



SCHMIEDEN-TAYLOR
17,0 cm, 6³/₄"
010-457-17

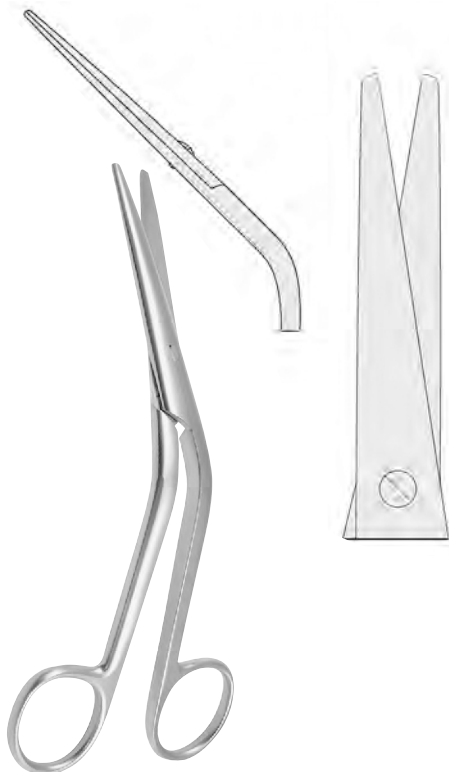


010-458-17 010-459-17

LINCOLN
17,0 cm, 6³/₄"



HEYMANN
18,0 cm, 7"
010-501-18



COTTLE
16,0 cm, 6¹/₄"
010-511-16



KIRSTEN
18,0 cm, 7"
010-517-18

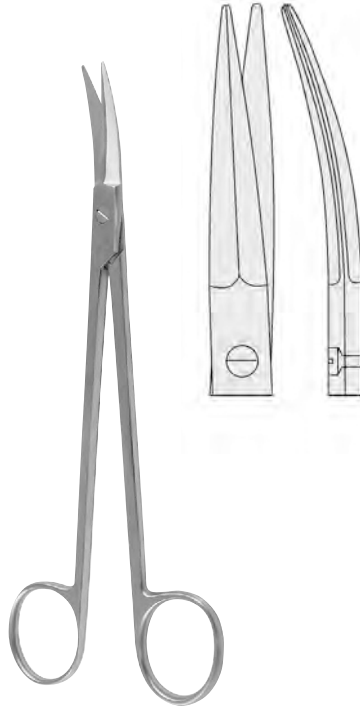


CAPLAN
22,0 cm, 8⁵/₈"
010-519-22

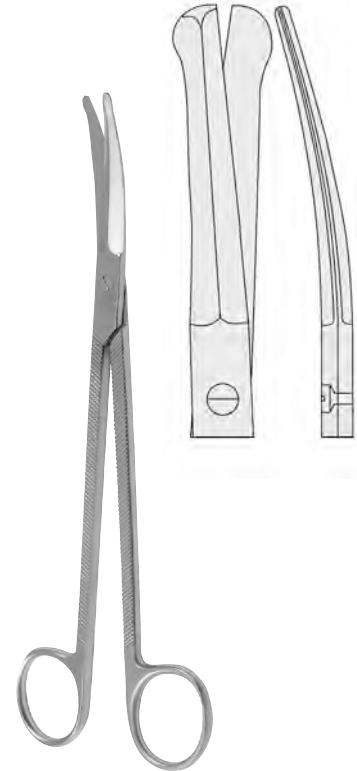
Tonsillenscheren, Nasenscheren, Gefäßscheren
 Tonsil Scissors, Nasal Scissors, Vascular Scissors
 Tijeras para amígdalas, Tijeras para el tabique nasal, Tijeras vasculares
 Forbici per tonsille, Forbici per il setto nasale, Forbici vascolari



BOETTCHER
 18,0 cm, 7"
 010-521-18



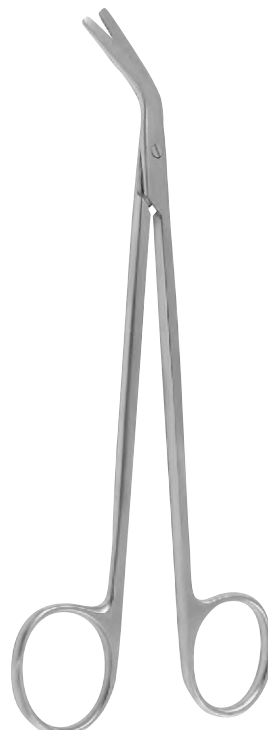
PRINCE
 17,5 cm, 6⁵/₈"
 010-523-17



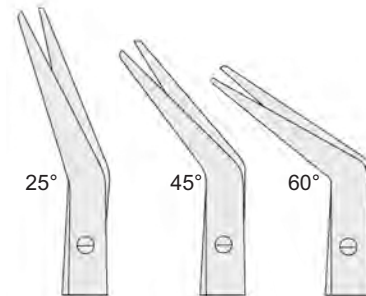
GOOD
 19,0 cm, 7¹/₂"
 010-525-19



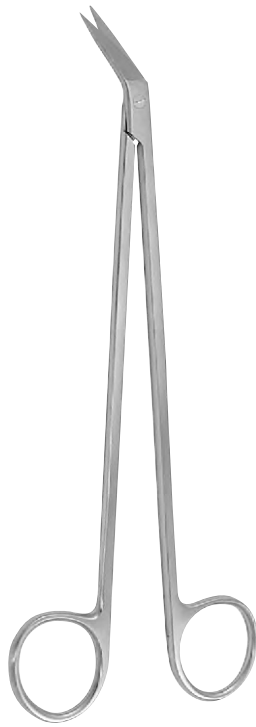
CARTILAGE
 20,0 cm, 8"
 010-528-20



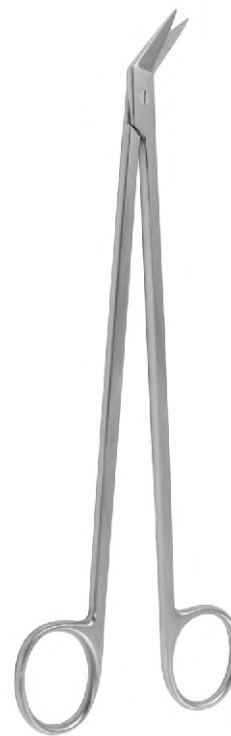
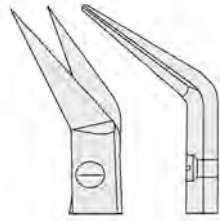
DE BAKEY



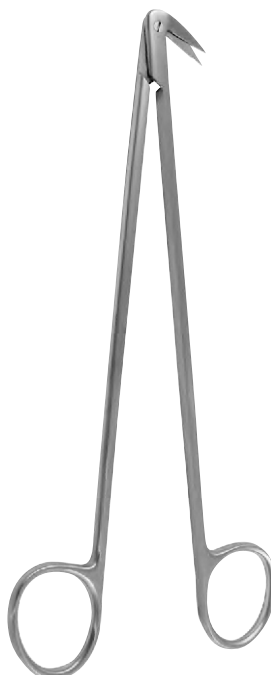
17,5 cm, 6 ⁵ / ₈ "	010-540-25	010-540-45	010-540-60
19,5 cm, 7 ³ / ₄ "	010-541-25	010-541-45	010-541-60
21,0 cm, 8 ¹ / ₄ "	010-542-25	010-542-45	010-542-60
23,0 cm, 9"	010-543-25	010-543-45	010-543-60
28,0 cm, 11"	010-544-25	010-544-45	010-544-60



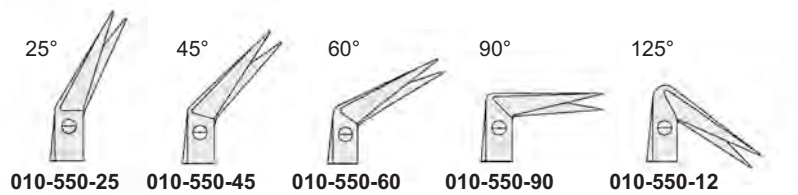
POTTS-SMITH
18,0 cm, 7"
010-547-18



POTTS DE MARTEL
21,0 cm, 8 1/4" 010-548-21
24,0 cm, 9 1/2" 010-548-24

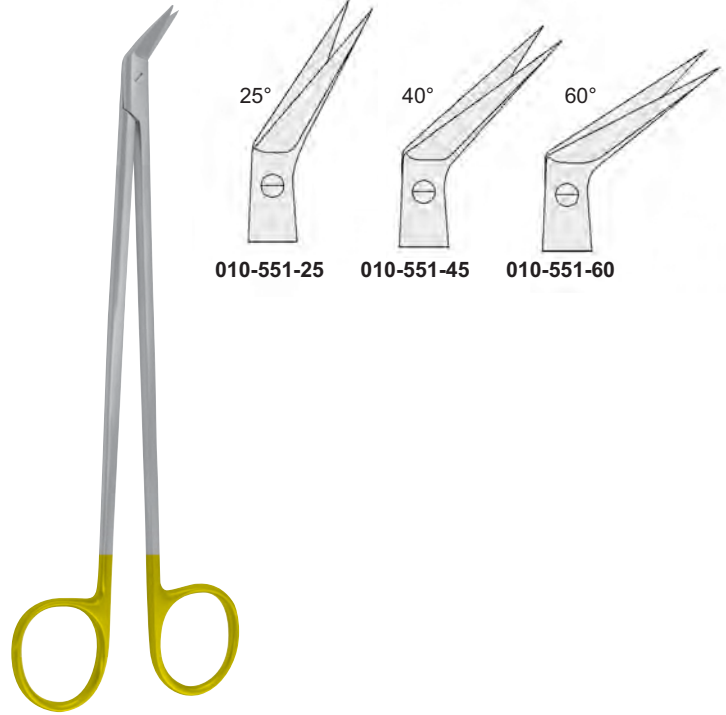


DIETRICH-HEGEMANN
19,0 cm, 7 1/2"





DIETRICH
 20,0 cm, 7 1/2"
 010-552-12

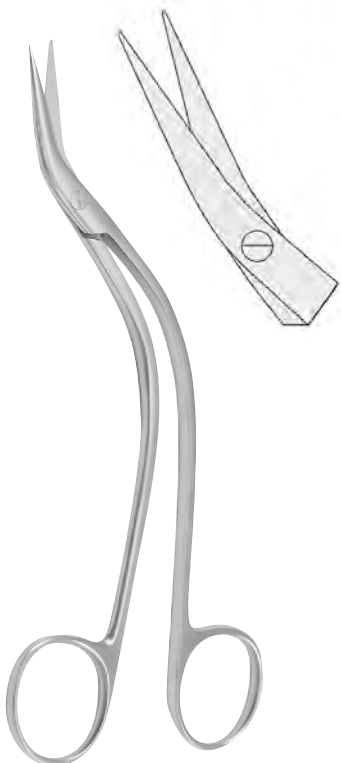


POTTS-SMITH
 19,0 cm, 7 1/2"

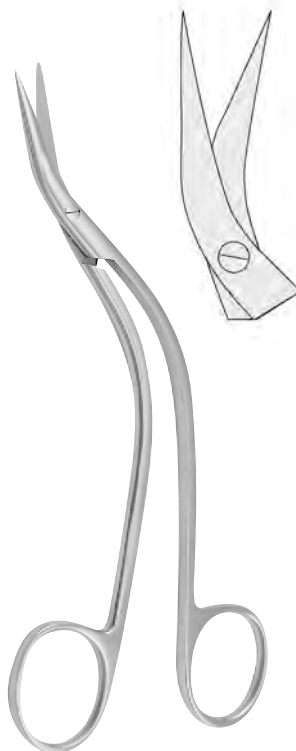
25°
 010-551-25

40°
 010-551-45

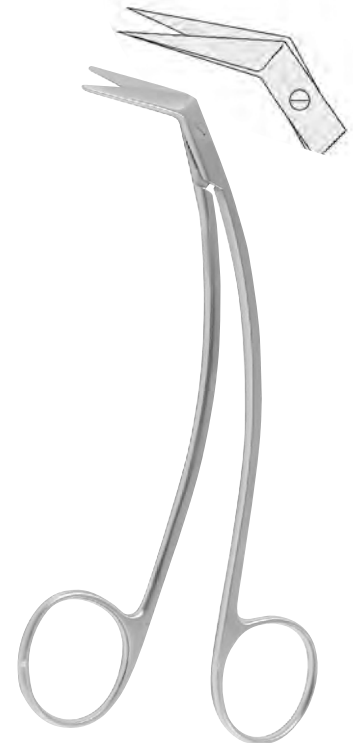
60°
 010-551-60



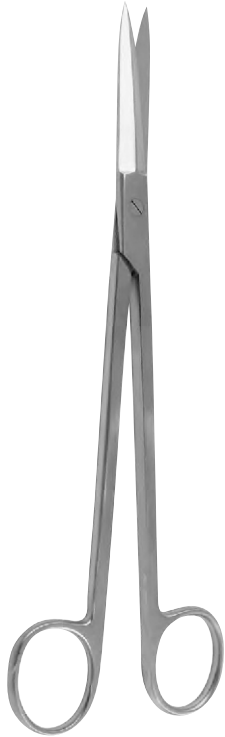
DE BAKEY
 15,5 cm, 6"
 010-560-15



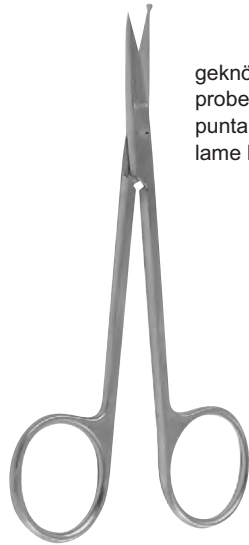
DE BAKEY
 15,5 cm, 6"
 010-561-15



DE BAKEY
 15,5 cm, 6"
 010-562-15



MC INDOE
19,0 cm, 7½"
010-570-19



geknöpftes Blatt
probe-pointed blade
punta botonda
lame bottonuta

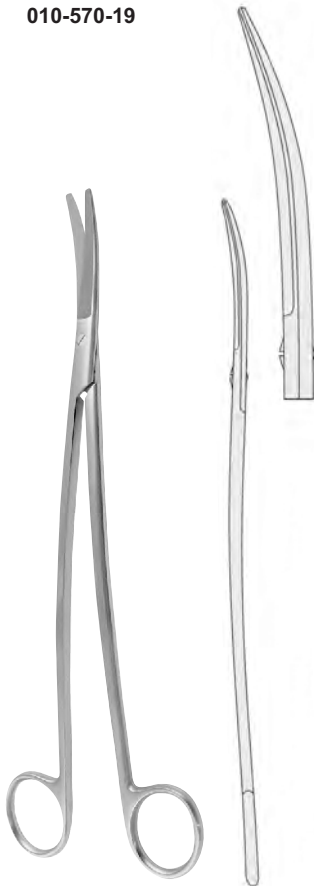
11,5 cm, 4½"
010-572-11



CRAFOORD
30,0 cm, 12"
010-575-30



SATINSKY
15,5 cm, 9⅝"
010-577-24



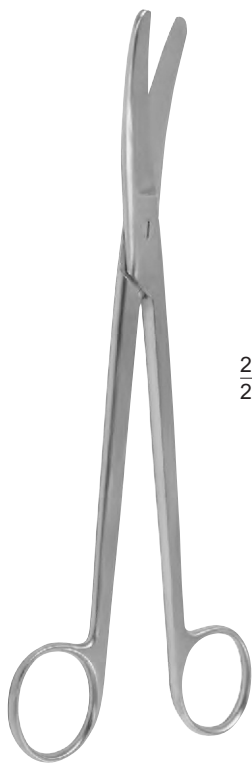
KLINGENBERG-LOTH
23,0 cm, 9"
010-579-23



SIMS

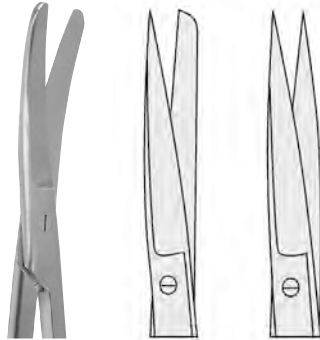


20,0 cm, 8" 010-600-20 010-602-20 010-604-20
23,0 cm, 9" 010-600-23 010-602-23 010-604-23



SIMS

20,0 cm, 8"	010-601-20	010-603-20	010-605-20
23,0 cm, 9"	010-601-23	010-603-23	010-605-23



SIEBOLD
 24,0 cm, 9 1/2"
010-620-24

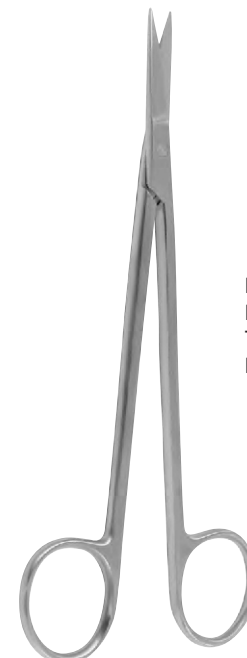
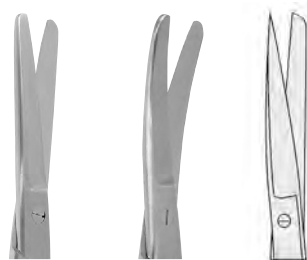


BOZEMANN
 22,0 cm, 8 3/4"
010-622-22



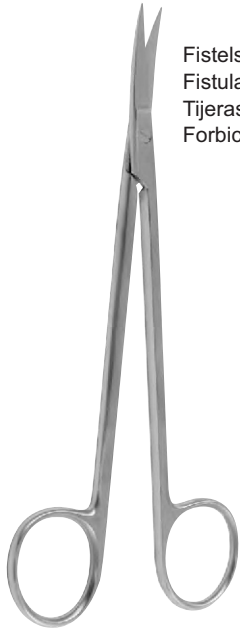
DOYEN

16,0 cm, 6 1/4"	010-610-16	010-611-16	010-612-16
17,5 cm, 6 7/8"	010-610-17	010-611-17	



KELLY
 16,0 cm, 6 1/4" **010-634-16**
 18,0 cm, 7" **010-634-18**

Fistelscheren
 Fistula scissors
 Tijeras para fistulas
 Forbici per fistole



Fistelscheren
 Fistula scissors
 Tijeras para fistulas
 Forbici per fistole

KELLY
 16,0 cm, 6¹/₄" **010-635-16**
 18,0 cm, 7" **010-635-18**



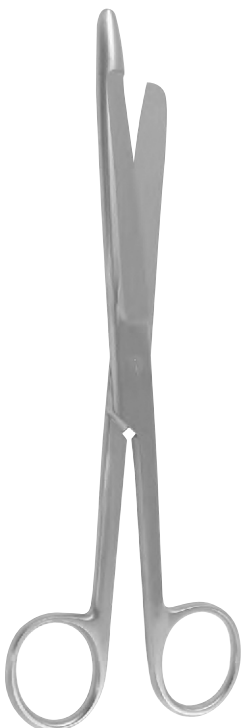
WERTHEIM
 19,5 cm, 7³/₄" **010-640-19**
 22,5 cm, 8³/₄" **010-640-23**



DUBOIS
 27,0 cm, 10⁵/₈"
010-650-18



010-651-18



21,0 cm, 8¹/₄"
010-670-21



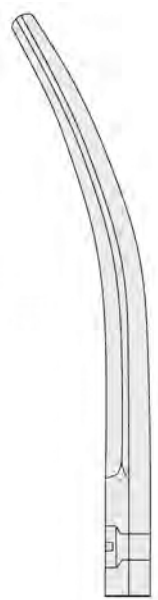
21,0 cm, 8¹/₄"
010-672-21



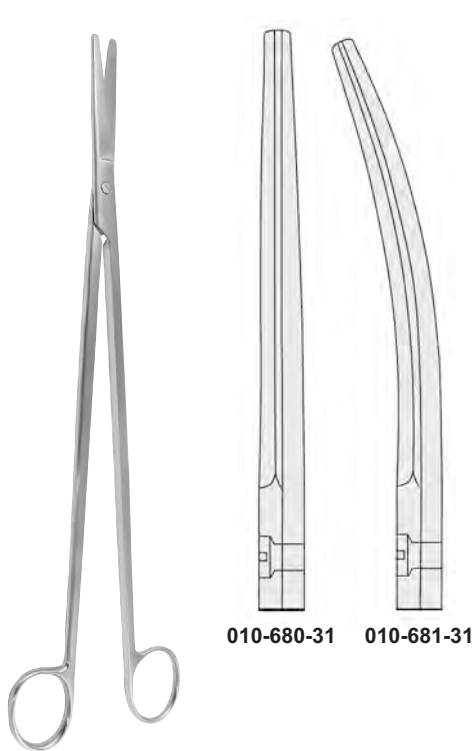
21,0 cm, 8¹/₄"
010-674-21



LLOYD-DAVIES
 27,0 cm, 10⁵/₈"
010-677-27

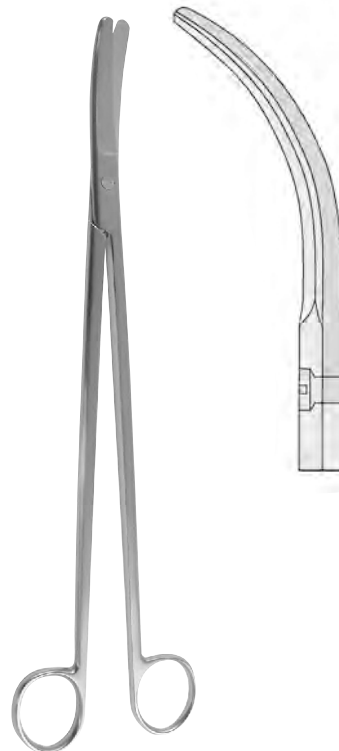


Lungenlappen- und Rektumscheren, Lungenscheren, Dammscheren
 Lobectomy and Rectal Scissors, Lobectomy Scissors, Episiotomy Scissors
 Tijeras para lobectomía y recto, Tijera para lobectomía, Tijeras para episiotomía
 Forbici per lobo polmonare e per il retto, Forbici per lobo, Forbici per episiotomia



010-680-31 010-681-31

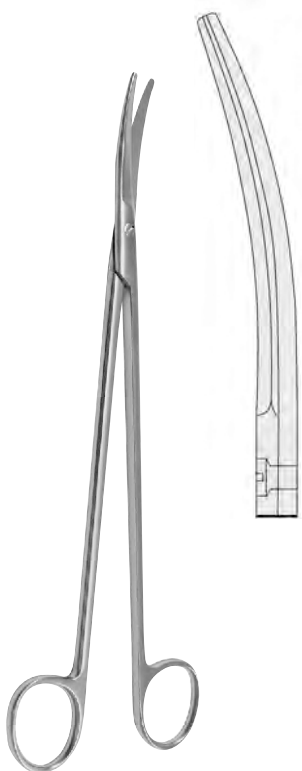
STELZNER
 31,0 cm, 12¹/₄"



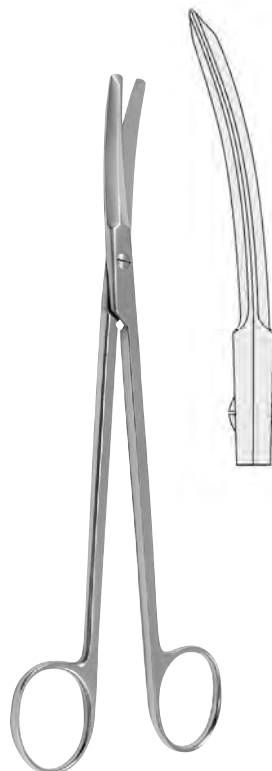
RECTAL
 32,5 cm, 12³/₄"
 010-685-32



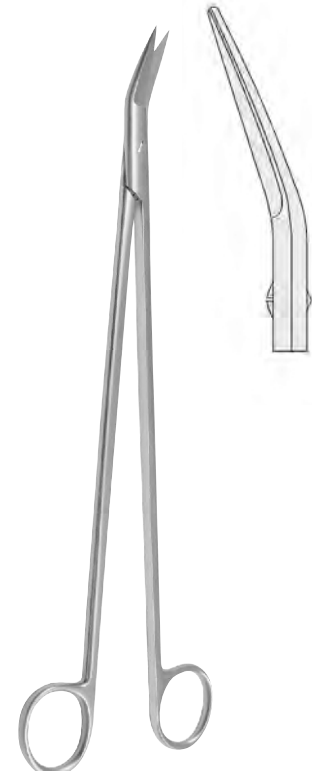
WILLAUER
 25,0 cm, 9³/₄" 010-688-25
 28,0 cm, 11" 010-688-28



WILLAUER
 25,0 cm, 9³/₄" 010-689-25
 28,0 cm, 11" 010-689-28



POTTS-SMITH
 19,0 cm, 7¹/₂"
 010-691-19



FINOCHIETTO
 32,5 cm, 10⁵/₈"
 010-693-27



WALDMANN
 18,0 cm, 7"
 010-695-18



BRAUN-STADLER
 14,5 cm, 5³/₄" 010-701-14
 20,0 cm, 8" 010-701-20



20,0 cm, 8"
 010-703-20



MOD. USA
 10,5 cm, 4¹/₈"
 010-706-10



BUSCH
 13,5 cm, 5³/₈" 010-707-13
 16,0 cm, 6¹/₄" 010-707-16



SCHUMACHER
 16,0 cm, 16¹/₄"
 010-709-16



gezahnt
 serrated
 dentada
 dentata

UNIVERSAL
 12,0 cm, 4³/₄"
 010-800-12



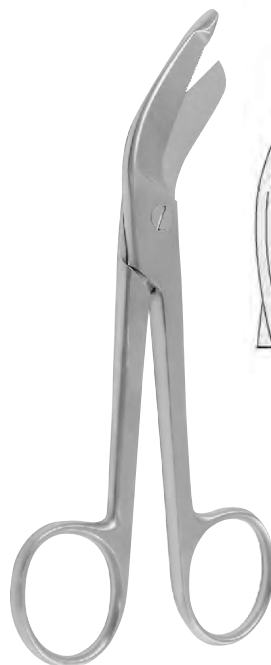
LISTER

9,0 cm, 3 1/2"	010-900-09
11,0 cm, 4 ³ / ₈ "	010-900-11
14,0 cm, 5 ¹ / ₂ "	010-900-14
18,0 cm, 7"	010-900-18
20,0 cm, 8"	010-900-20



LISTER

18,5 cm, 7 ¹ / ₄ "	010-901-18
21,0 cm, 8 ¹ / ₄ "	010-901-21



LISTER-EXCENTRIC

16,0 cm, 6 ¹ / ₄ "	010-903-16
19,0 cm, 7 ¹ / ₂ "	010-903-19



gezahnt
 serrated
 dentada
 dentata



BERGMANN

23,0 cm, 9"	010-905-23
-------------	-------------------

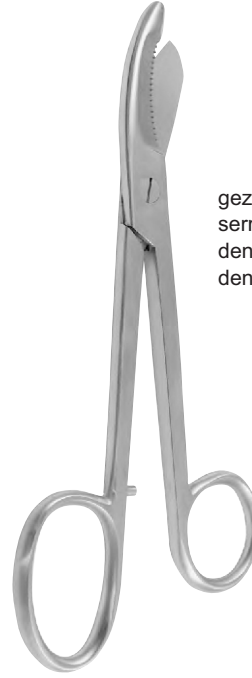




ESMARCH
 20,0 cm, 8" **010-907-20**
 22,0 cm, 8⁵/₈" **010-907-22**

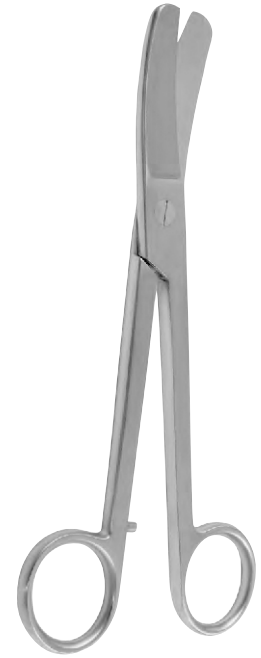


KNOWLES
 14,0 cm, 5¹/₂"
010-920-14



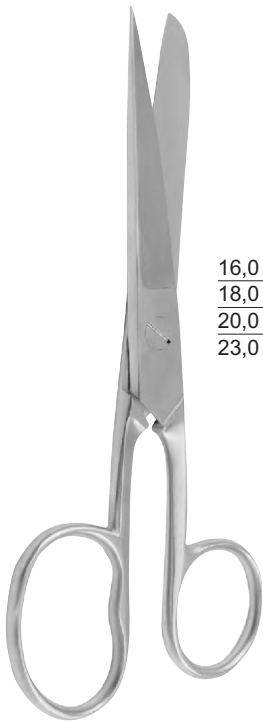
gezahnt
 serrated
 dentada
 dentata

BRUNS
 24,0 cm, 9¹/₂"
010-909-24
010-910-24



LORENZ
 23,0 cm, 9"
010-930-23

bis 134°C autoklavierbar
 autoclavable up to 134°C
 esterilizable en autoclave hasta 134°C
 Sterilizzabile in autoclave fino 134°C



SMITH
 (MOD. USA)

16,0 cm, 6¹/₄" **010-940-16**
 18,0 cm, 7" **010-940-18**
 20,0 cm, 8" **010-940-20**
 23,0 cm, 9" **010-940-23**



gezahnt
 serrated
 dentada
 dentata

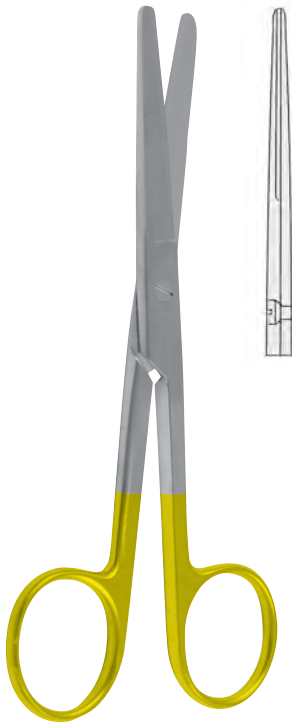
20,0 cm, 8"
010-941-20



gezahnt
 serrated
 dentada
 dentata

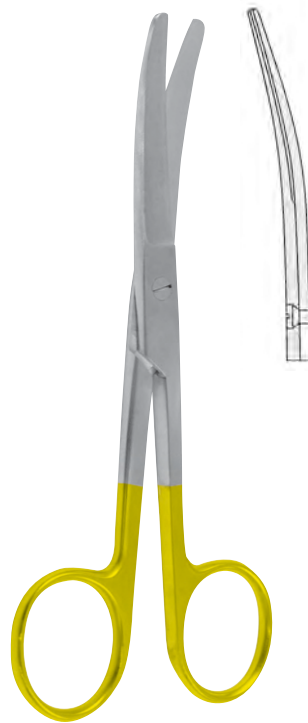
UNIVERSAL
 14,0 cm, 5¹/₂" **010-950-14**
 16,0 cm, 6¹/₄" **010-950-16**
 18,0 cm, 7" **010-950-18**

Chirurgische Scheren mit Hartmetallschneiden
 Surgical Scissors with tungsten carbide edges
 Tijeras para cirugía con filos de carburo tungsteno
 Forbici per chirurgia con lame in carburo di tungsteno



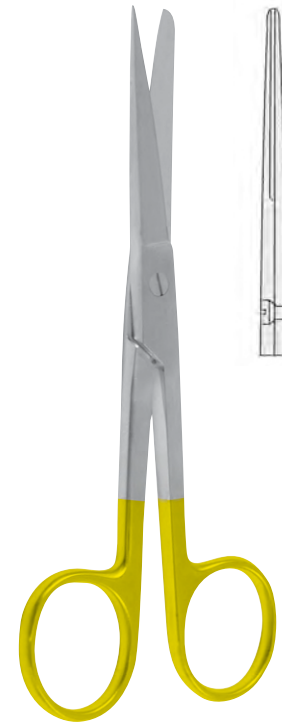
STANDARD

14,5 cm, 5 ³ / ₄ "	011-000-14
16,5 cm, 6 ¹ / ₂ "	011-000-16
18,5 cm, 7 ¹ / ₄ "	011-000-18



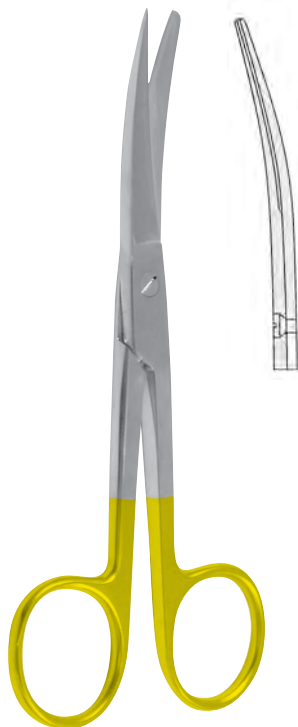
STANDARD

14,5 cm, 5 ³ / ₄ "	011-001-14
16,5 cm, 6 ¹ / ₂ "	011-001-16
18,5 cm, 7 ¹ / ₄ "	011-001-18



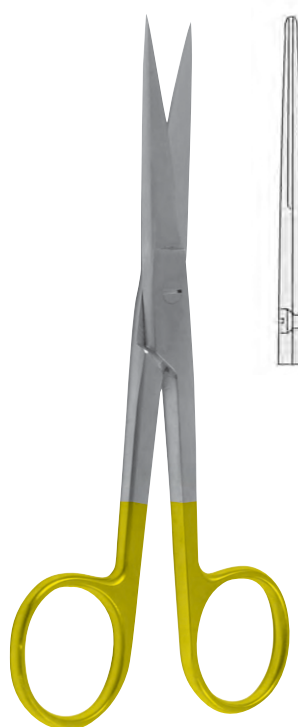
STANDARD

14,5 cm, 5 ³ / ₄ "	011-002-14
16,5 cm, 6 ¹ / ₂ "	011-002-16
18,5 cm, 7 ¹ / ₄ "	011-002-18



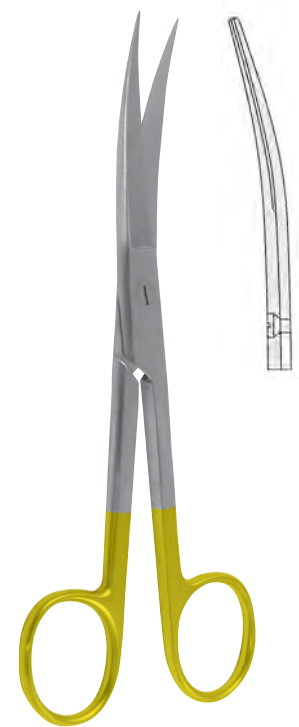
STANDARD

14,5 cm, 5 ³ / ₄ "	011-003-14
16,5 cm, 6 ¹ / ₂ "	011-003-16
18,5 cm, 7 ¹ / ₄ "	011-003-18



STANDARD

14,5 cm, 5 ³ / ₄ "	011-004-14
16,5 cm, 6 ¹ / ₂ "	011-004-16
18,5 cm, 7 ¹ / ₄ "	011-004-18



STANDARD

14,5 cm, 5 ³ / ₄ "	011-005-14
16,5 cm, 6 ¹ / ₂ "	011-005-16
18,5 cm, 7 ¹ / ₄ "	011-005-18



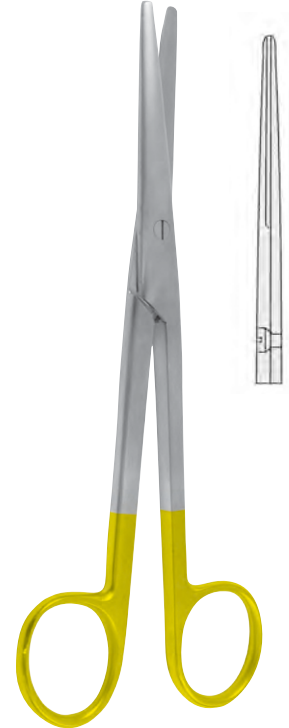
MAYO

14,5 cm, 5 ³ / ₄ "	011-100-14
17,0 cm, 6 ³ / ₄ "	011-100-17
23,0 cm, 9"	011-100-23



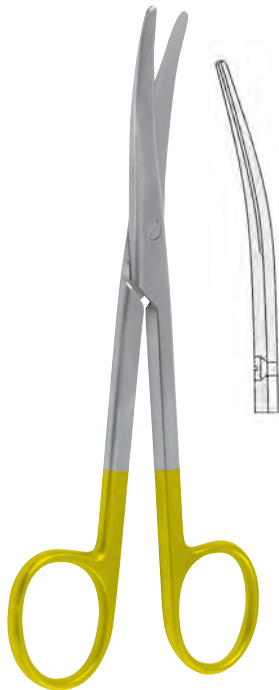
MAYO

14,5 cm, 5 ³ / ₄ "	011-101-14
17,0 cm, 6 ³ / ₄ "	011-101-17
23,0 cm, 9"	011-101-23



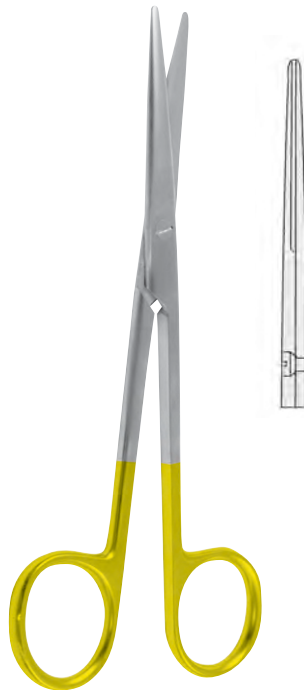
MAYO-STILLE

15,0 cm, 6"	011-102-15
17,0 cm, 6 ³ / ₄ "	011-102-17



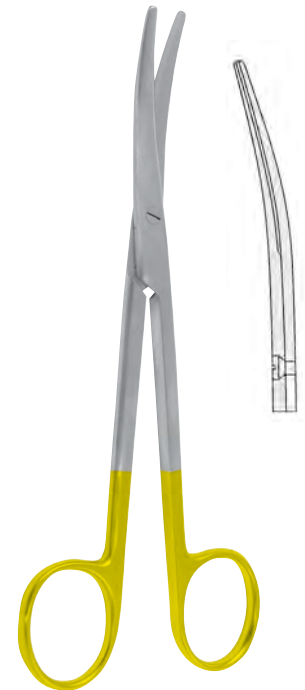
MAYO-STILLE

15,0 cm, 6"	011-103-15
17,0 cm, 6 ³ / ₄ "	011-103-17



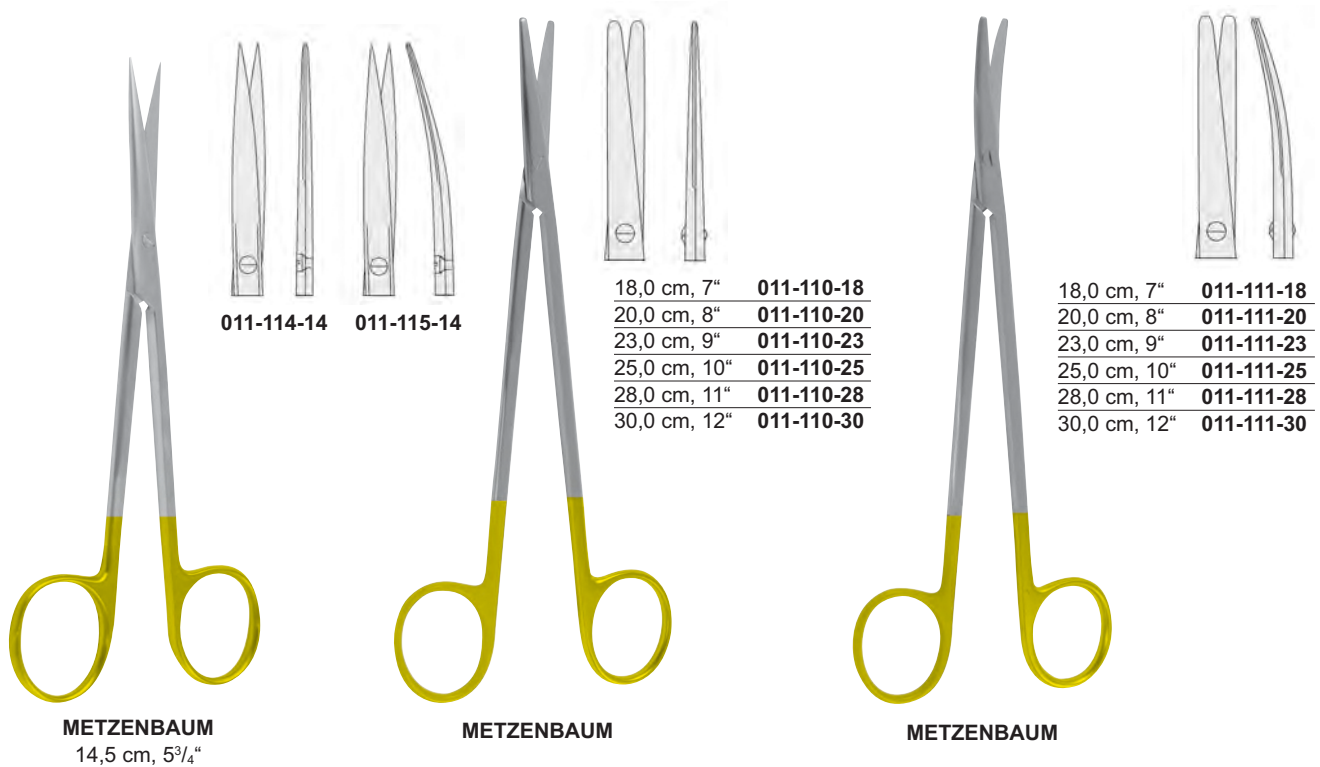
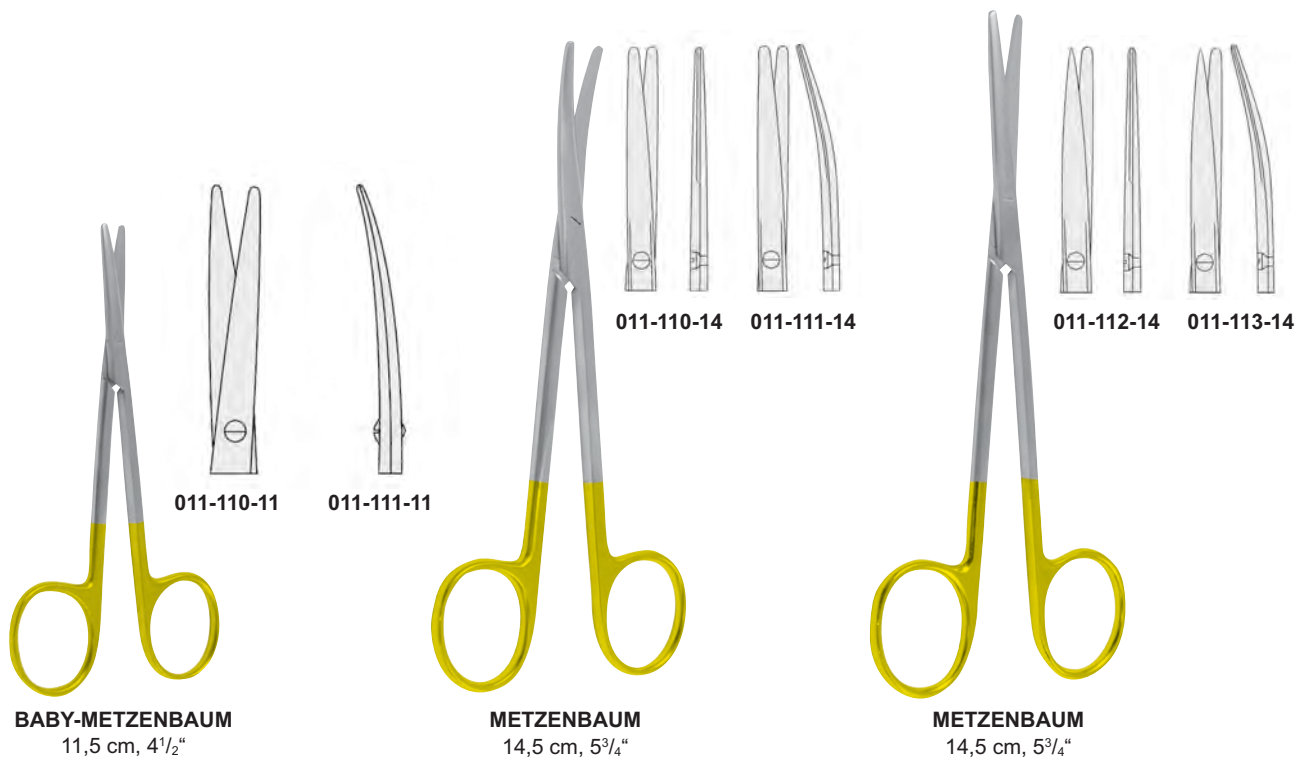
LEXER

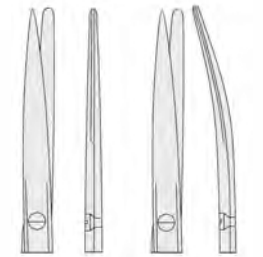
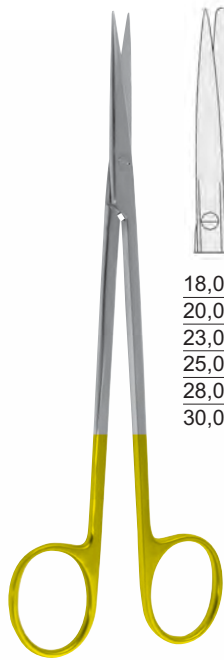
16,0 cm, 6 ¹ / ₄ "	011-140-16
21,0 cm, 8 ¹ / ₄ "	011-140-21



LEXER

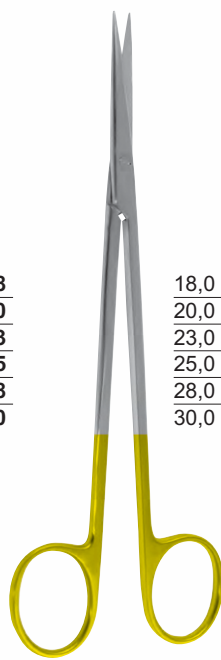
16,0 cm, 6 ¹ / ₄ "	011-141-16
21,0 cm, 8 ¹ / ₄ "	011-141-21





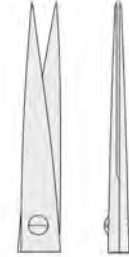
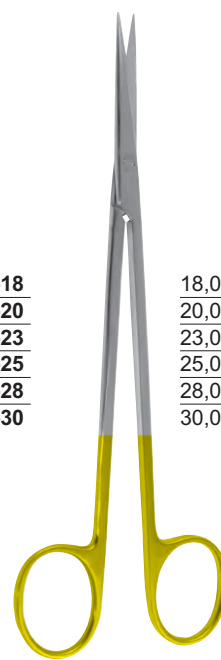
18,0 cm, 7"	011-112-18
20,0 cm, 8"	011-112-20
23,0 cm, 9"	011-112-23
25,0 cm, 10"	011-112-25
28,0 cm, 11"	011-112-28
30,0 cm, 12"	011-112-30

METZENBAUM



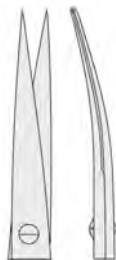
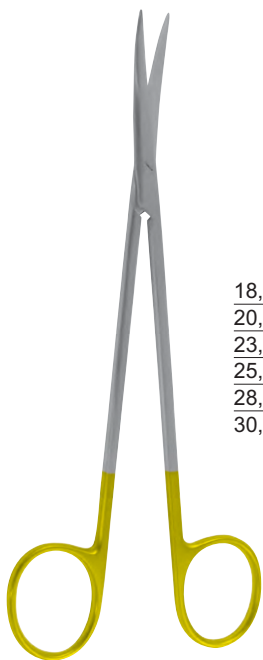
18,0 cm, 7"	011-113-18
20,0 cm, 8"	011-113-20
23,0 cm, 9"	011-113-23
25,0 cm, 10"	011-113-25
28,0 cm, 11"	011-113-28
30,0 cm, 12"	011-113-30

METZENBAUM



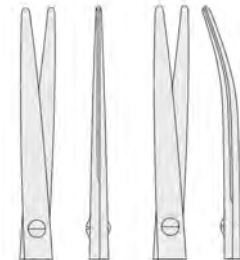
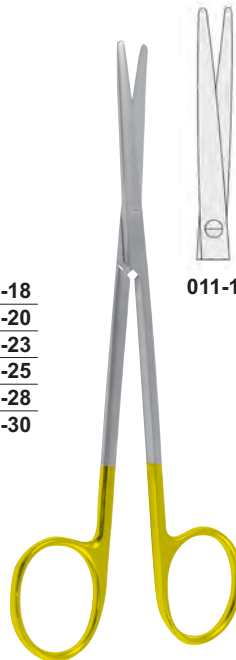
18,0 cm, 7"	011-114-18
20,0 cm, 8"	011-114-20
23,0 cm, 9"	011-114-23
25,0 cm, 10"	011-114-25
28,0 cm, 11"	011-114-28
30,0 cm, 12"	011-114-30

METZENBAUM



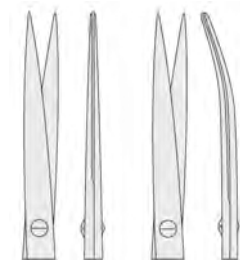
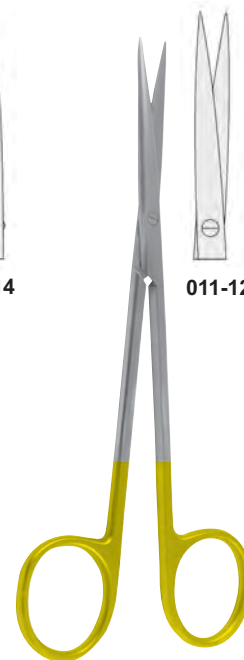
18,0 cm, 7"	011-115-18
20,0 cm, 8"	011-115-20
23,0 cm, 9"	011-115-23
25,0 cm, 10"	011-115-25
28,0 cm, 11"	011-115-28
30,0 cm, 12"	011-115-30

METZENBAUM



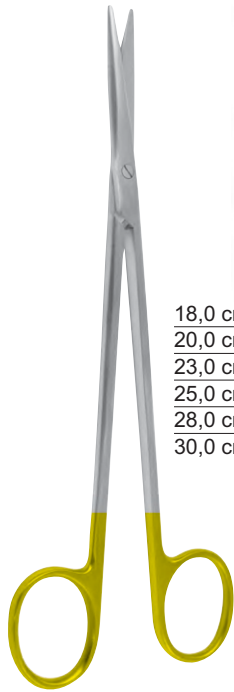
011-120-14 **011-121-14**

METZENBAUM-FINO
14,5 cm, 5³/₄"



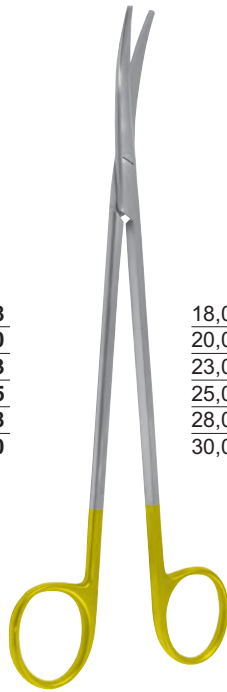
011-124-14 **011-125-14**

METZENBAUM-FINO
14,5 cm, 5³/₄"



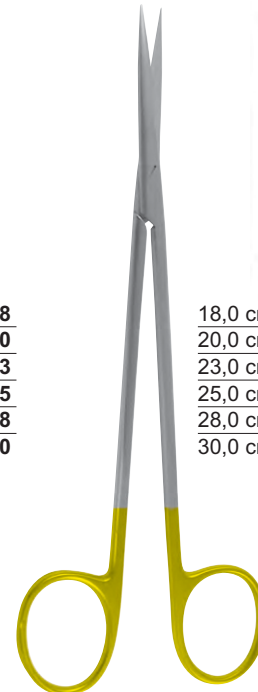
18,0 cm, 7"	011-120-18
20,0 cm, 8"	011-120-20
23,0 cm, 9"	011-120-23
25,0 cm, 10"	011-120-25
28,0 cm, 11"	011-120-28
30,0 cm, 12"	011-120-30

METZENBAUM-FINO



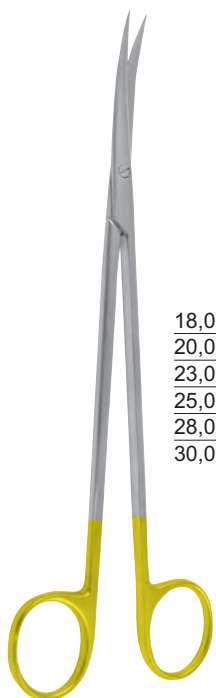
18,0 cm, 7"	011-121-18
20,0 cm, 8"	011-121-20
23,0 cm, 9"	011-121-23
25,0 cm, 10"	011-121-25
28,0 cm, 11"	011-121-28
30,0 cm, 12"	011-121-30

METZENBAUM-FINO



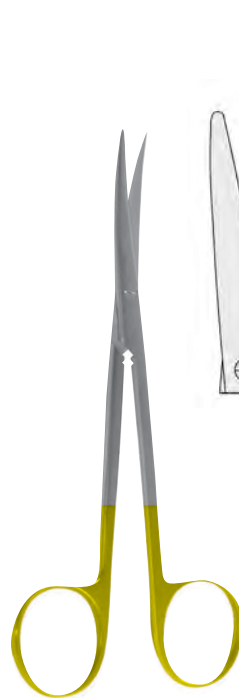
18,0 cm, 7"	011-124-18
20,0 cm, 8"	011-124-20
23,0 cm, 9"	011-124-23
25,0 cm, 10"	011-124-25
28,0 cm, 11"	011-124-28
30,0 cm, 12"	011-124-30

METZENBAUM-FINO

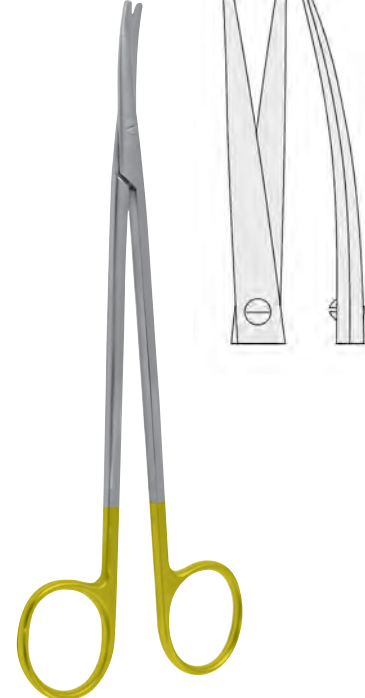


18,0 cm, 7"	011-125-18
20,0 cm, 8"	011-125-20
23,0 cm, 9"	011-125-23
25,0 cm, 10"	011-125-25
28,0 cm, 11"	011-125-28
30,0 cm, 12"	011-125-30

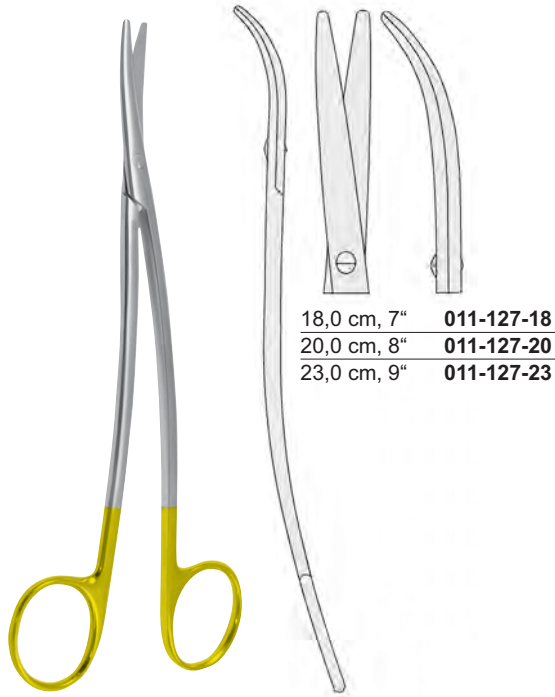
METZENBAUM-FINO



METZENBAUM-LAHEY
 14,0 cm, 5 1/2"
011-137-14

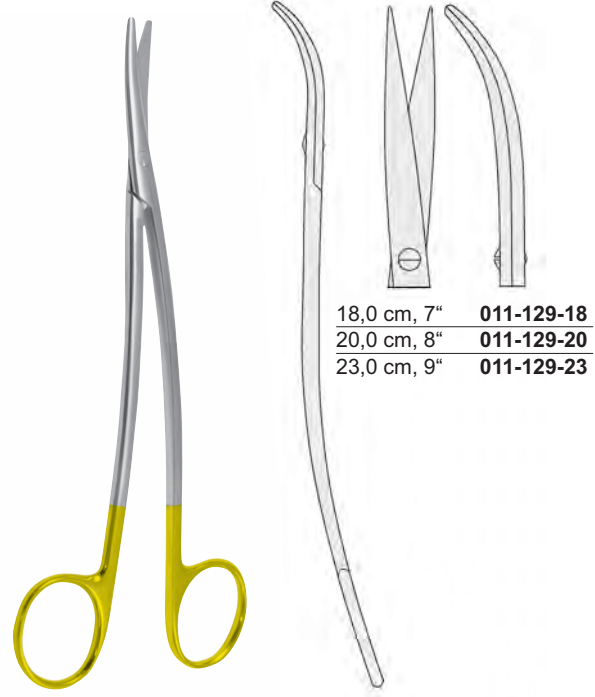


TOENNIS-ADSON
 17,0 cm, 6 3/4"
011-139-17



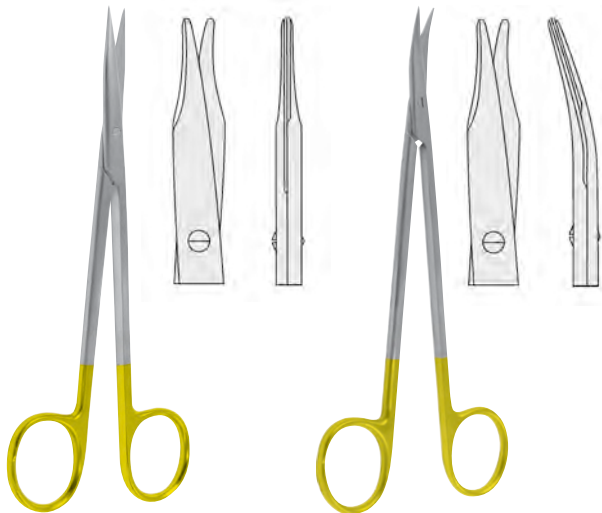
18,0 cm, 7" **011-127-18**
 20,0 cm, 8" **011-127-20**
 23,0 cm, 9" **011-127-23**

METZENBAUM-FINO S

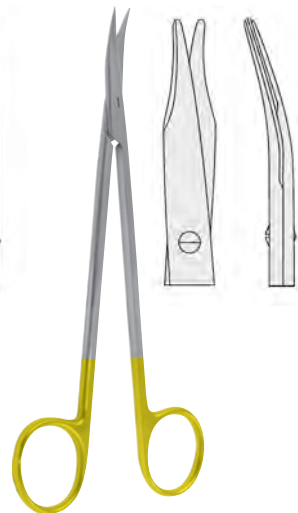


18,0 cm, 7" **011-129-18**
 20,0 cm, 8" **011-129-20**
 23,0 cm, 9" **011-129-23**

METZENBAUM-FINO S



REYNOLDS
 15,0 cm, 6"
011-210-15



REYNOLDS
 15,0 cm, 6"
011-211-15



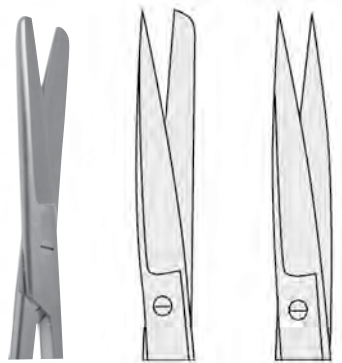
HYSTEREKTOMY
 25,5 cm, 10"
011-663-25

HYSTEREKTOMY
 25,0 cm, 9³/₄"
011-665-25

Gynäkologische Scheren mit Hartmetallschneiden
 Gynecology Scissors with tungsten carbide edges
 Tijeras para ginecología con filos de carburo tungsteno
 Forbici per ginecologia con lame in carburo di tungsteno



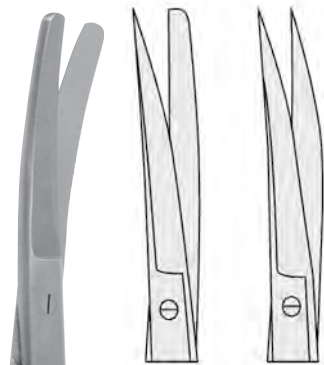
SIMS



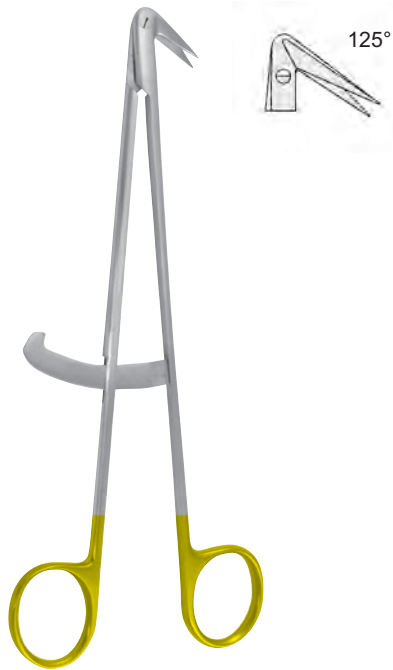
20,0 cm, 8"	011-600-20	011-602-20	011-604-20
23,0 cm, 9"	011-600-23	011-602-23	011-604-23



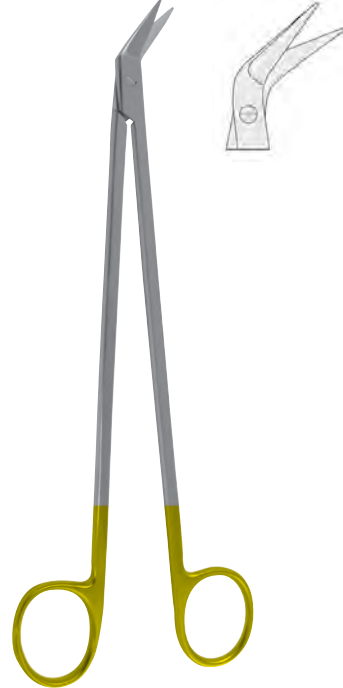
SIMS



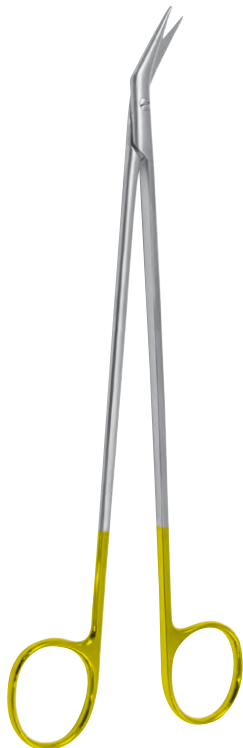
20,0 cm, 8"	011-601-20	011-603-20	011-605-20
23,0 cm, 9"	011-601-23	011-603-23	011-605-23



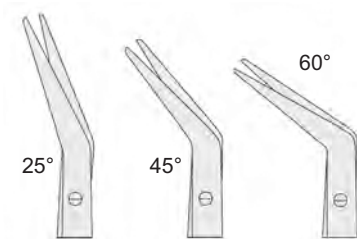
DIETRICH
 17,5 cm, 6⁷/₈"
 011-552-17



POTTS DE MARTEL
 24,0 cm, 9¹/₂"
 011-548-24

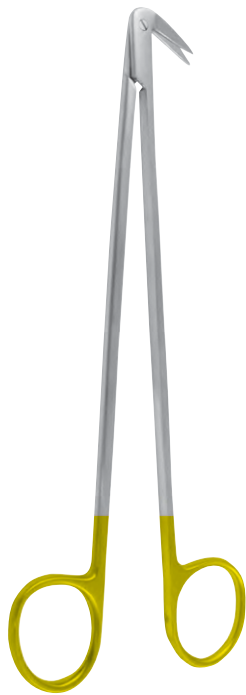


DE BAKEY

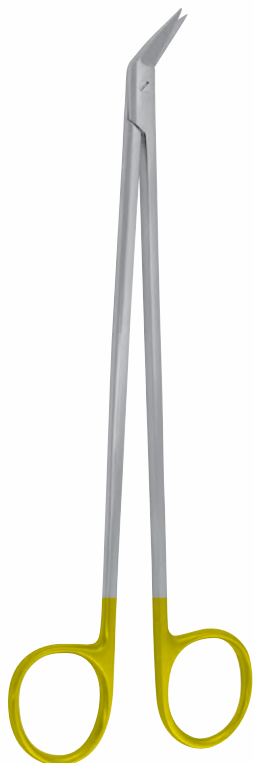


20,0 cm, 8"	011-543-25	011-543-45	011-543-60
23,0 cm, 9"	011-545-25	011-545-45	011-545-60

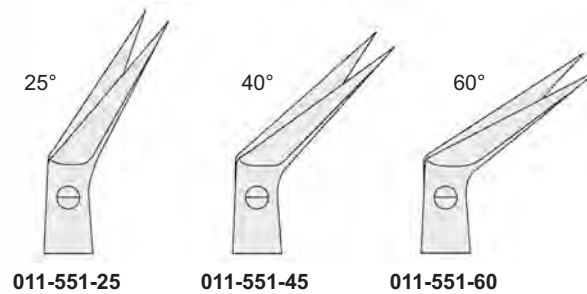
Gefäßscheren mit Hartmetallschneiden
Vascular Scissors with tungsten carbide edges
Tijeras vasculares con filos de carburo tungsteno
Forbici vascolari con lame in carburo di tungsteno



DIETHRICH-HEGEMANN
18,0 cm, 7"



POTTS-SMITH
18,0 cm, 7 1/2"





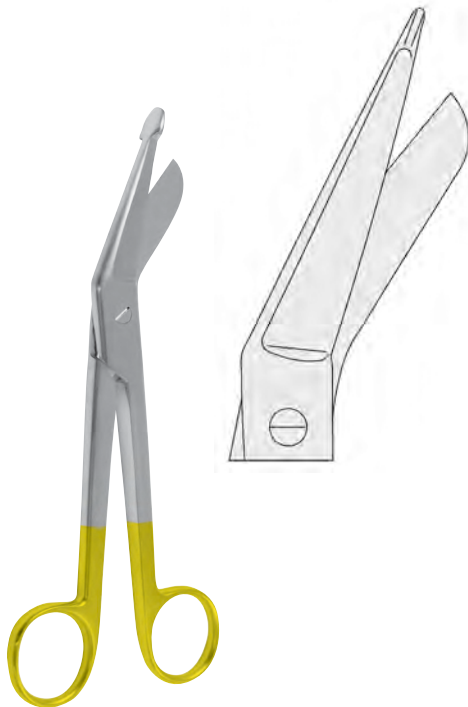
011-244-11 011-245-11

IRIS
11,5 cm, 4 1/2"

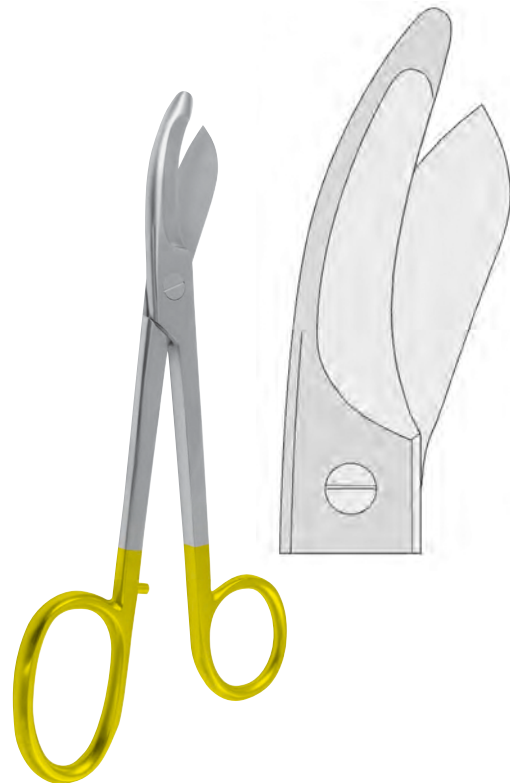


gezahnt
serrated
dentada
dentata

UNIVERSAL
12,0 cm, 4 3/4"
011-800-12

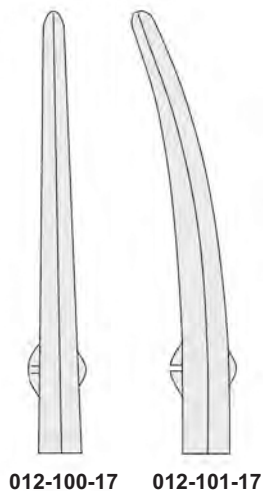


LISTER
18,0 cm, 7"
011-900-18

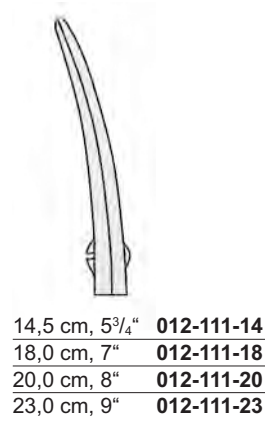
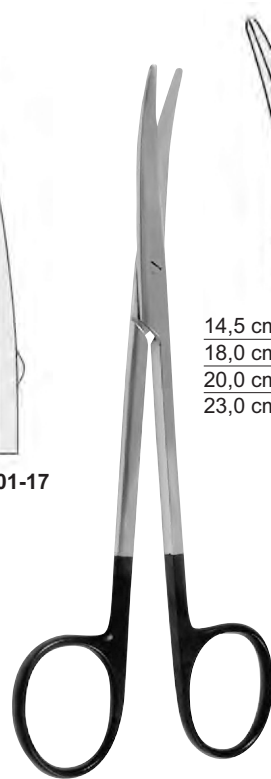


BRUNS
24,0 cm, 9 1/2"
011-909-24

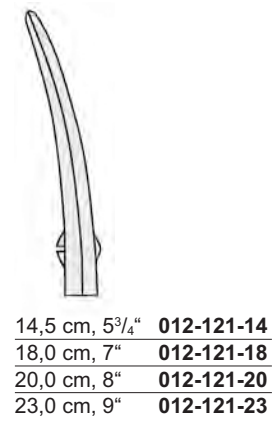
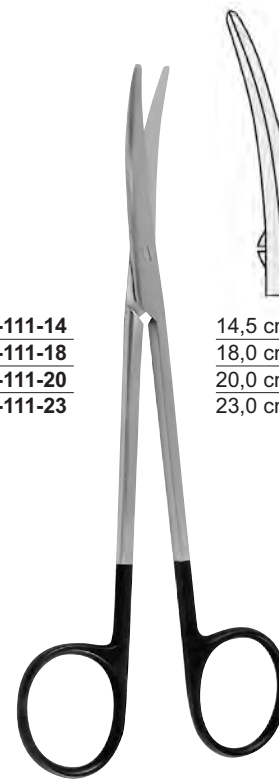
Super-Cut Scheren
 Super-Cut Scissors
 Tijeras Super-Cut
 Forbici Super-Cut



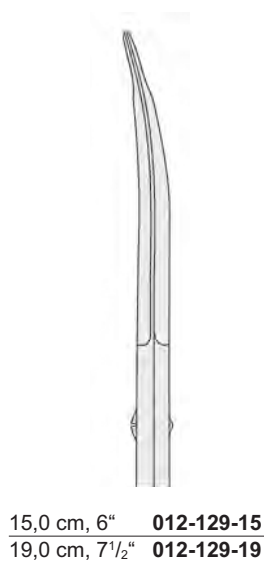
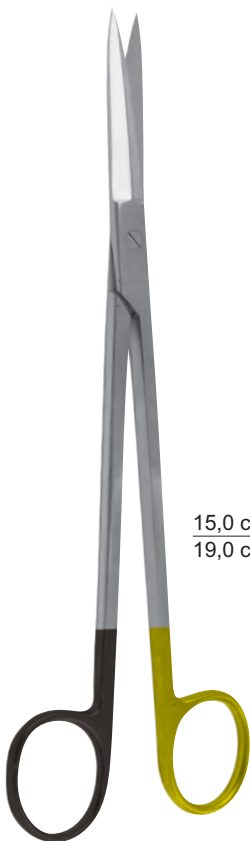
MAYO
 17,0 cm, 6³/₄"



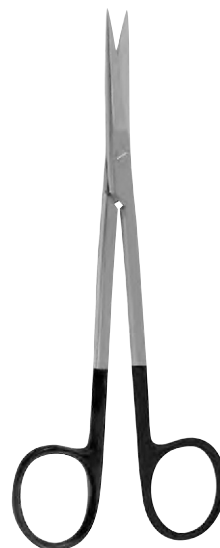
METZENBAUM



METZENBAUM-FINO



KAYE FACE LIFT



JABALEY
 13,0 cm, 5"
 012-130-13



TOENNIS-ADSON
 17,0 cm, 6³/₄"
 012-139-17



STRABISMUS
 11,5 cm, 4 $\frac{1}{2}$ "



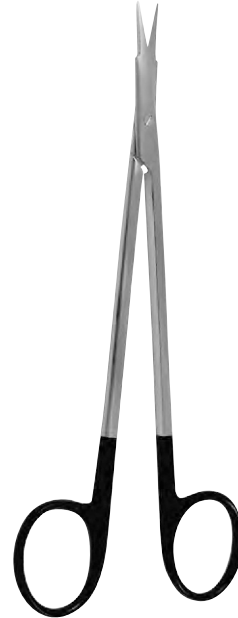
012-240-11



012-241-11



JAMISON
 15,0 cm, 6" 012-218-15
 18,0 cm, 7" 012-218-18



REYNOLDS
 12,5 cm, 5"
 012-210-12



BABY-METZENBAUM
 11,0 cm, 4 $\frac{3}{8}$ " 012-110-11
 14,5 cm, 5 $\frac{3}{4}$ " 012-110-14



IRIS
 11,0 cm, 4 $\frac{3}{8}$ "
 012-244-11



IRIS
 11,0 cm, 4 $\frac{3}{8}$ "
 012-245-11



STEVENS TENOTOMY
 11,0 cm, 4 $\frac{3}{8}$ "
 012-290-11



STEVENS T ENOTOMY
 11,0 cm, 4 $\frac{3}{8}$ "
 012-291-11



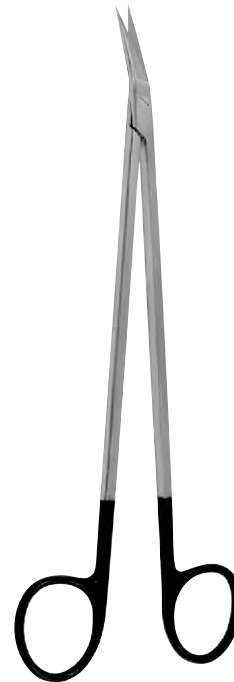
gerade
straight

PAR TYPE
 12,0 cm, 4³/₄"
 012-200-12



gebogen
curved

PAR TYPE
 12,0 cm, 4³/₄"
 012-201-12



POTTS
 19,0 cm, 7¹/₂"



012-551-25



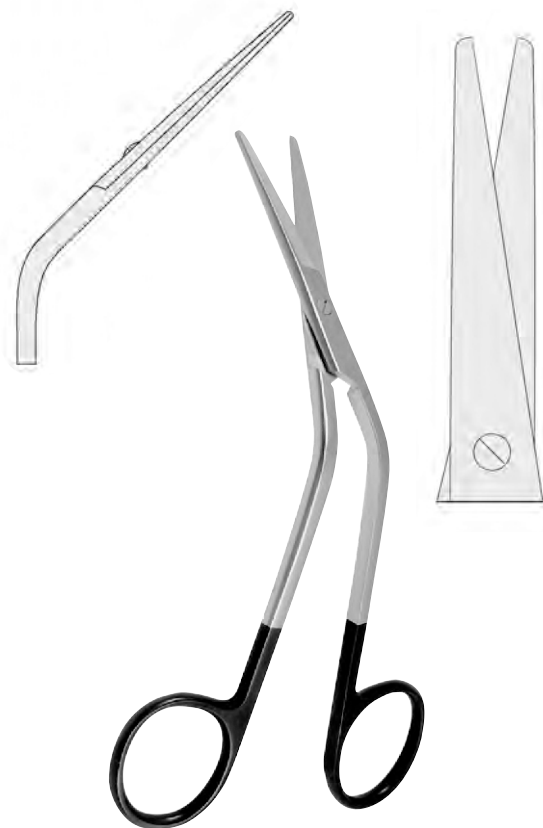
012-551-45



012-551-60



FOMON
 14,5 cm, 5³/₄"
 012-343-15



COTTLE
 16,5 cm, 6¹/₂"
 012-511-16



018-081-11

018-083-11

WESTCOTT
11,0 cm, 4³/₈"



gezahnt
serrated
dentada
dentata

GOMEL

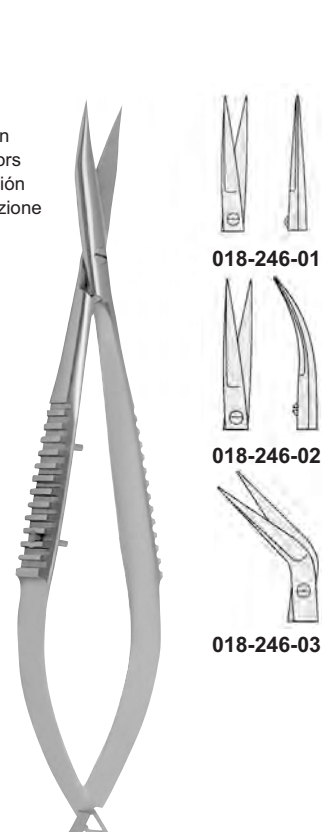
14,0 cm, 5¹/₂" **018-241-14Z**
16,0 cm, 6¹/₄" **018-241-16Z**



Mikro-Präparierscheren
Micro-dissecting scissors
Micro-tijeras de disección
Micro-forbici per dissezione

HEPP SCHEIDEL

14,0 cm, 5¹/₂" **018-243-14**
16,0 cm, 6¹/₄" **018-243-16**



018-246-01

018-246-02

018-246-03

18,5 cm, 7¹/₄"



STEVENS



18,5 cm, 7¹/₄" **018-290-01** **018-290-02** **018-290-03** **018-290-04**
22,5 cm, 8³/₄" **018-291-01** **018-291-02** **018-291-03** **018-291-04**

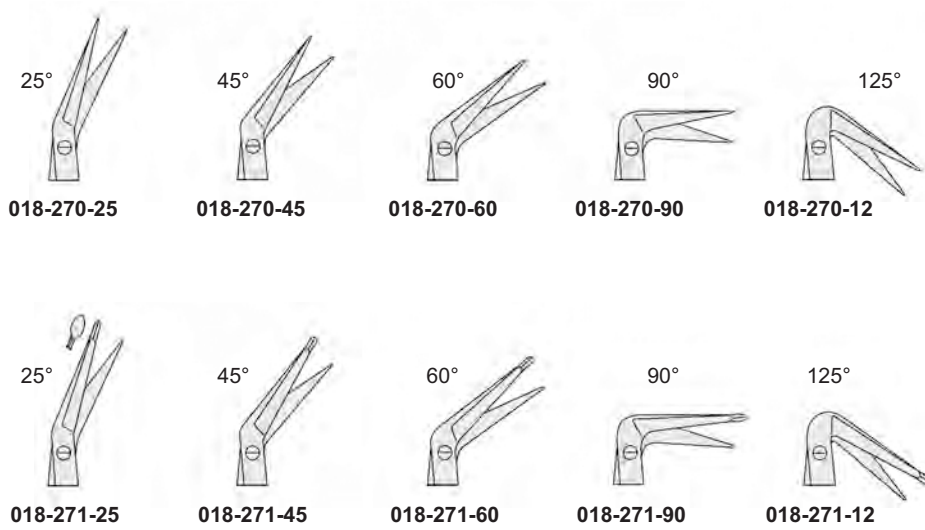


18,5 cm, 7¹/₄" **018-292-01** **018-292-02**
22,5 cm, 8³/₄" **018-293-01** **018-293-02**

Mikro-Scheren, Mikro-Disektionsscheren
 Micro Scissors, Micro Dissecting Scissors
 Micro-Tijeras, Micro-Tijeras de disección
 Micro-Forbici, Micro-Forbici per dissezione



18,0 cm, 7"



018-270-25

018-270-45

018-270-60

018-270-90

018-270-12

018-271-25

018-271-45

018-271-60

018-271-90

018-271-12



15,0 cm, 6"
018-223-15



15,0 cm, 6"
018-223-15Z

gezahnt
serrated
dentada
dentata



15,0 cm, 6"
018-201-15



18,0 cm, 7"
018-201-18



15,0 cm, 6"
018-232-15



15,0 cm, 6"
018-232-15Z



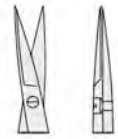
gezahnt
serrated
dentada
dentata



15,0 cm, 6"
018-203-15



18,0 cm, 7"
018-203-18





STANDARD

10,5 cm, 4 ¹ / ₈ "	020-002-10
11,5 cm, 4 ¹ / ₂ "	020-002-11
13,0 cm, 5"	020-002-13
14,5 cm, 5 ³ / ₄ "	020-002-14
15,0 cm, 6"	020-002-15
16,0 cm, 6 ¹ / ₄ "	020-002-16
18,0 cm, 7"	020-002-18
20,0 cm, 8"	020-002-20
25,0 cm, 10"	020-002-25
30,0 cm, 12"	020-002-30



schmal
 narrow
 estrechos
 stretti

STANDARD

10,5 cm, 4 ¹ / ₈ "	020-003-10
11,5 cm, 4 ¹ / ₂ "	020-003-11
13,0 cm, 5"	020-003-13
14,5 cm, 5 ³ / ₄ "	020-003-14
15,0 cm, 6"	020-003-15
16,0 cm, 6 ¹ / ₄ "	020-003-16
18,0 cm, 7"	020-003-18
20,0 cm, 8"	020-003-20
25,0 cm, 10"	020-003-25
30,0 cm, 12"	020-003-30



schmal
 narrow
 estrechos
 stretti

STANDARD

10,5 cm, 4 ¹ / ₈ "	020-004-10
11,5 cm, 4 ¹ / ₂ "	020-004-11
13,0 cm, 5"	020-004-13
14,5 cm, 5 ³ / ₄ "	020-004-14
15,0 cm, 6"	020-004-15
16,0 cm, 6 ¹ / ₄ "	020-004-16
18,0 cm, 7"	020-004-18
20,0 cm, 8"	020-004-20
25,0 cm, 10"	020-004-25
30,0 cm, 12"	020-004-30



fein
 fine
 finas
 fini

STANDARD

10,5 cm, 4 ¹ / ₈ "	020-010-10
11,5 cm, 4 ¹ / ₂ "	020-010-11
13,0 cm, 5"	020-010-13
14,5 cm, 5 ³ / ₄ "	020-010-14
15,0 cm, 6"	020-010-15
16,0 cm, 6 ¹ / ₄ "	020-010-16
18,0 cm, 7"	020-010-18
20,0 cm, 8"	020-010-20
25,0 cm, 10"	020-010-25
30,0 cm, 12"	020-010-30



fein
fine
finas
fini
тонкие

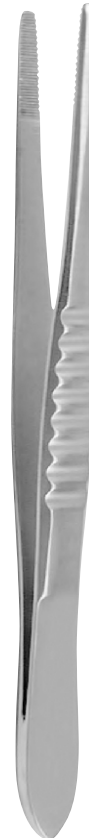
10,5 cm, 4 ¹ / ₈ "	020-011-10
11,5 cm, 4 ¹ / ₂ "	020-011-11
13,0 cm, 5"	020-011-13
14,5 cm, 5 ³ / ₄ "	020-011-14
16,0 cm, 6 ¹ / ₄ "	020-011-16
18,0 cm, 7"	020-011-18
20,0 cm, 8"	020-011-20
25,0 cm, 10"	020-011-25
30,0 cm, 12"	020-011-30



fein
fine
finas
fini

mit Stift
with pin
con perno
con espiga

10,5 cm, 4 ¹ / ₈ "	020-018-10
11,5 cm, 4 ¹ / ₂ "	020-018-11
13,0 cm, 5"	020-018-13
14,5 cm, 5 ³ / ₄ "	020-018-14
16,0 cm, 6 ¹ / ₄ "	020-018-16
18,0 cm, 7"	020-018-18
20,0 cm, 8"	020-018-20
25,0 cm, 10"	020-018-25
30,0 cm, 12"	020-018-30



MOD. USA

12,0 cm, 4 ³ / ₄ "	020-006-10
13,0 cm, 5"	020-006-13
14,5 cm, 5 ³ / ₄ "	020-006-14
15,0 cm, 6"	020-006-15
18,0 cm, 7"	020-006-18
20,0 cm, 8"	020-006-20
25,5 cm, 10"	020-006-25
30,0 cm, 12"	020-006-30

schmal
narrow
estrechos
stretti
узкие

MOD. USA

12,0 cm, 4 ³ / ₄ "	020-012-11
13,0 cm, 5"	020-012-13
14,5 cm, 5 ³ / ₄ "	020-012-14
15,0 cm, 6"	020-012-15
18,0 cm, 7"	020-012-18
20,0 cm, 8"	020-012-20
25,5 cm, 10"	020-012-25



ADSON

12,0 cm, 4³/₄" **020-070-12**
 15,0 cm, 6" **020-070-15**



MICRO-ADSON

12,0 cm, 4³/₄" **020-076-12**
 15,0 cm, 6" **020-076-15**



STILLE

15,0 cm, 6"
020-008-15



MC INDOE

15,0 cm, 6"
020-158-15



TAYLOR

17,5 cm, 6⁵/₈"
020-114-17



TAYLOR

17,5 cm, 6⁵/₈"
020-115-17



TAYLOR

18,5 cm, 7¹/₄"
020-117-18



GERALD

18,0 cm, 7"
020-102-18



GERALD
18,0 cm, 7"
020-103-18



POTTS-SMITH
18,0 cm, 7" **020-026-18**
21,0 cm, 8 1/4" **020-026-21**
25,0 cm, 10" **020-026-25**



POTTS-SMITH
18,0 cm, 7" **020-027-18**
21,0 cm, 8 1/4" **020-027-21**
25,0 cm, 10" **020-027-25**



SEMKEN
12,5 cm, 5" **020-040-12**
15,0 cm, 6" **020-040-15**



CUSHING
17,5 cm, 6 5/8"
020-092-17



CUSHING
17,5 cm, 6 5/8"
020-093-17



BROPHY
20,0 cm, 8"
020-094-20

Anatomische Pinzetten
 Dissecting Forceps
 Pinzas de disección
 Pinze anatomiche per dissezione
 Пинцеты анатомические



BROPHY
 20,0 cm, 8"
 020-095-20



BONNEY
 18,0 cm, 7"
 020-120-18



SINGLE-TUTTLE
 23,0 cm, 9"
 020-516-23



DENNIS BROWN
 20,0 cm, 8"
 020-126-20



DUEHRSSSEN
 20,0 cm, 8"
 020-470-20



WAUGH
 15,0 cm, 6" 020-130-15
 20,0 cm, 8" 020-130-20



RAMSEY
 18,0 cm, 7"
 020-136-18

1 x 2



STANDARD	
10,5 cm, 4 ¹ / ₈ "	020-200-10
11,5 cm, 4 ¹ / ₂ "	020-200-11
13,0 cm, 5"	020-200-13
14,5 cm, 5 ³ / ₄ "	020-200-14
15,0 cm, 6"	020-200-15
16,0 cm, 6 ¹ / ₄ "	020-200-16
18,0 cm, 7"	020-200-18
20,0 cm, 8"	020-200-20
25,0 cm, 10"	020-200-25
30,0 cm, 12"	020-200-30

2 x 3



11,5 cm, 4 ¹ / ₂ "	020-252-11
13,0 cm, 5"	020-252-13
14,5 cm, 5 ³ / ₄ "	020-252-14
16,0 cm, 6 ¹ / ₄ "	020-252-16
18,0 cm, 7"	020-252-18
20,0 cm, 8"	020-252-20
25,0 cm, 10"	020-252-25
30,0 cm, 12"	020-252-30

3 x 4



13,0 cm, 5"	020-254-13
14,5 cm, 5 ³ / ₄ "	020-254-14
16,0 cm, 6 ¹ / ₄ "	020-254-16
18,0 cm, 7"	020-254-18
20,0 cm, 8"	020-254-20

4 x 5



13,0 cm, 5"	020-256-13
14,5 cm, 5 ³ / ₄ "	020-256-14
16,0 cm, 6 ¹ / ₄ "	020-256-16
18,0 cm, 7"	020-256-18
20,0 cm, 8"	020-256-20

fein
fine
finas
fini

mit Stift
with pin
con perno
con espiga

mit Stift
with pin
con perno
con espiga

englische Modelle
english patterns
modelos ingleses
modelli inglese

1 x 2

1 x 2

1 x 2

1 x 2



13,0 cm, 5"	020-210-13
14,5 cm, 5 ³ / ₄ "	020-210-14
15,5 cm, 6"	020-210-15
16,0 cm, 6 ¹ / ₄ "	020-210-16
18,0 cm, 7"	020-210-18
20,0 cm, 8"	020-210-20
25,0 cm, 10"	020-210-25
30,0 cm, 12"	020-210-30

13,0 cm, 5"	020-218-13
14,5 cm, 5 ³ / ₄ "	020-218-14
15,5 cm, 6"	020-218-15
16,0 cm, 6 ¹ / ₄ "	020-218-16
18,0 cm, 7"	020-218-18
20,0 cm, 8"	020-218-20
25,0 cm, 10"	020-218-25
30,0 cm, 12"	020-218-30

13,0 cm, 5"	020-219-13
14,5 cm, 5 ³ / ₄ "	020-219-14
16,0 cm, 6 ¹ / ₄ "	020-219-16
18,0 cm, 7"	020-219-18
20,0 cm, 8"	020-219-20

13,0 cm, 5"	020-236-13
14,5 cm, 5 ³ / ₄ "	020-236-14
15,0 cm, 6"	020-236-15

1 x 2



MOD. USA

12,0 cm, 4 ³ / ₄ "	020-206-12
13,0 cm, 5"	020-206-13
14,5 cm, 5 ³ / ₄ "	020-206-14
15,5 cm, 6"	020-206-15
18,0 cm, 7"	020-206-18
20,0 cm, 8"	020-206-20
25,0 cm, 10"	020-206-25
30,0 cm, 12"	020-206-30

2 x 3



MOD. USA

12,0 cm, 4 ³ / ₄ "	020-212-12
13,0 cm, 5"	020-212-13
14,5 cm, 5 ³ / ₄ "	020-212-14
15,5 cm, 6"	020-212-15
18,0 cm, 7"	020-212-18
20,0 cm, 8"	020-212-20
25,0 cm, 10"	020-212-25
30,0 cm, 12"	020-212-30

1 x 2



ADSON

12,0 cm, 4 ³ / ₄ "	020-270-12
15,0 cm, 6"	020-270-15

1 x 2



MICRO-ADSON

12,0 cm, 4 ³ / ₄ "	020-276-12
15,0 cm, 6"	020-276-15

Chirurgische Pinzetten
 Tissue Forceps
 Pinzas quirúrgicas
 Pinze per chirurgia
 Пинцеты хирургические



2 x 3



ADSON

12,0 cm, 4³/₄" **020-074-12**
 15,0 cm, 6" **020-074-15**

7 x 7



ADSON-BROWN

12,0 cm, 4³/₄" **020-288-12**
 15,0 cm, 6" **020-288-15**

1 x 2



ADSON

12,0 cm, 4³/₄"
020-282-12

1 x 2



STILLE

15,0 cm, 6"
020-208-15

2 x 3



STILLE

15,0 cm, 6"
020-209-15

1 x 2



GILLIES

15,0 cm, 6"
020-300-15

2 x 3



ADLERKREUTZ

15,0 cm, 6" **020-382-15**
 20,0 cm, 8" **020-382-20**

4 x 5



ADLERKREUTZ

15,0 cm, 6" **020-384-15**
 20,0 cm, 8" **020-384-20**

1 x 2



SEMKEN
12,5 cm, 5" 020-240-12
15,5 cm, 6" 020-240-15

2 x 3



SEMKEN
12,5 cm, 5" 020-242-12

1 x 2



MC INDOE
15,0 cm, 6" 020-358-15

1 x 2



TAYLOR
17,5 cm, 6⁵/₈" 020-314-17

1 x 2



TAYLOR
17,5 cm, 6⁵/₈" 020-315-17

1 x 2



TAYLOR
17,5 cm, 6⁵/₈" 020-317-17

1 x 2



GERALD
18,0 cm, 7" 020-302-18

1 x 2



GERALD
18,0 cm, 7" 020-303-18

1 x 2



CUSHING
17,5 cm, 6⁵/₈"
020-292-17

1 x 2



CUSHING
17,5 cm, 6⁵/₈"
020-293-17

1 x 2



POTTS-SMITH
18,0 cm, 7" 020-226-18
21,0 cm, 8¹/₄" 020-226-21
25,0 cm, 10" 020-226-25

1 x 2



WAUGH
15,0 cm, 6" 020-330-15
20,0 cm, 8" 020-330-20

1 x 2



BROPHY
20,0 cm, 8"
020-294-20



RUSS. MODELL
15,0 cm, 6" 020-456-15
20,0 cm, 8" 020-456-20
25,0 cm, 10" 020-456-25



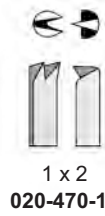
DURANTE

14,5 cm, 5 ³ / ₄ "	020-460-14
16,0 cm, 6 ¹ / ₄ "	020-460-16
20,0 cm, 8"	020-460-20



DUEHRSEN

20,0 cm, 8"



NELSON

15,0 cm, 6"	020-518-15
20,0 cm, 8"	020-518-20
23,0 cm, 9"	020-518-23



DUVAL
14,0 cm, 5¹/₂"



COLLIN-DUVAL
20,0 cm, 8"





LANE

14,5 cm, 5³/₄" **020-420-14**
20,0 cm, 8" **020-420-20**



LANE

14,5 cm, 5³/₄" **020-422-14**
20,0 cm, 8" **020-422-20**

7 x 7



BROWN

15,0 cm, 6" **020-410-15**
20,0 cm, 8" **020-410-20**
25,0 cm, 10" **020-410-25**



TREVES

13,0 cm, 5" **020-510-13**
15,0 cm, 6" **020-510-15**



RAMSEY
18,0 cm, 7"
020-520-18



RAMSEY
18,0 cm, 7"
020-522-18



RAMSEY
18,0 cm, 7"
020-590-18



RAMSEY
18,0 cm, 7"
020-592-18

mit Stift
with pin
con perno
con espiga

mit Stift
with pin
con perno
con espiga



8,0 cm, 3 1/4" **020-662-08**
9,0 cm, 3 1/2" **020-662-09**
10,5 cm, 4 1/8" **020-662-10**
11,5 cm, 4 1/2" **020-662-11**
13,0 cm, 5" **020-662-13**
14,5 cm, 5 1/2" **020-662-14**

8,0 cm, 3 1/4" **020-663-08**
9,0 cm, 3 1/2" **020-663-09**
10,5 cm, 4 1/8" **020-663-10**
11,5 cm, 4 1/2" **020-663-11**
13,0 cm, 5" **020-663-13**
14,5 cm, 5 1/2" **020-663-14**

8,0 cm, 3 1/4" **020-666-08**
9,0 cm, 3 1/2" **020-666-09**
10,5 cm, 4 1/8" **020-666-10**
11,5 cm, 4 1/2" **020-666-11**
13,0 cm, 5" **020-666-13**
14,5 cm, 5 1/2" **020-666-14**

8,0 cm, 3 1/4" **020-667-08**
9,0 cm, 3 1/2" **020-667-09**
10,5 cm, 4 1/8" **020-667-10**
11,5 cm, 4 1/2" **020-667-11**
13,0 cm, 5" **020-667-13**
14,5 cm, 5 1/2" **020-667-14**

Splitterpinzetten, Mikro-Pinzetten
 Splinter Forceps, Micro Forceps
 Pinzas para espinas, Pinzas para microscopia
 Pinze per schegge, Pinze per microscopia



HUNTER
 10,5 cm, 4 1/4"
 020-652-10



HUNTER
 10,5 cm, 4 1/4"
 020-653-10



WALTER-CARMALT
 10,5 cm, 4 1/4"
 020-656-10



WALTER-CARMALT
 10,5 cm, 4 1/4"
 020-657-10



FEILCHENFELD
 7,5 cm, 3 1/8" 020-650-07
 9,0 cm, 3 1/2" 020-650-09
 11,5 cm, 4 1/2" 020-650-11



10,0 cm, 4"
 020-806-10



10,0 cm, 4"
 020-807-10



GRAEFE
10,0 cm, 4"
020-810-10



GRAEFE
10,0 cm, 4"
020-811-10



GRAEFE
10,0 cm, 4"
020-813-10



GRAEFE
10,0 cm, 4"
020-814-10



GRAEFE
10,0 cm, 4"
020-815-10



GRAEFE
10,0 cm, 4"
020-817-10



Fig. 3
 11,5 cm, 4 1/2"
 020-601-03

0,3 mm x 45°



Fig. 4
 11,5 cm, 4 1/2"
 020-601-04

0,3 mm x 90°



Fig. 5
 11,5 cm, 4 1/2"
 020-601-05

0,3 mm



Fig. 7
 11,5 cm, 4 1/2"
 020-601-07

0,3 mm x 45°



9 mm

11,0 cm, 4 3/8"
 020-620-01



9 mm

11,0 cm, 4 3/8"
 020-620-02



9 mm

11,0 cm, 4 3/8"
 020-620-03



9 mm

11,0 cm, 4 3/8"
 020-620-04

diamantbeschichtet
 diamond coated
 diamantado
 diamantato



DE BAKEY

1,5 mm 2,0 mm 2,4 mm 2,8 mm



16,0 cm, 6 ¹ / ₄ "	020-700-16	020-702-16	020-704-16	020-706-16
20,0 cm, 8"	020-700-20	020-702-20	020-704-20	020-706-20
24,0 cm, 9 ¹ / ₂ "	020-700-24	020-702-24	020-704-24	020-706-24
30,0 cm, 12"	020-700-30	020-702-30	020-704-30	020-706-30

2,8 mm 3,5 mm 3,5 mm



16,0 cm, 6 ¹ / ₄ "	020-716-16	020-708-16	020-718-16
20,0 cm, 8"	020-716-20	020-708-20	020-718-20
24,0 cm, 9 ¹ / ₂ "	020-716-24	020-708-24	020-718-24
30,0 cm, 12"	020-716-30	020-708-30	020-718-30



DE BAKEY

1,5 mm 2,0 mm



16,0 cm, 6 ¹ / ₄ "	020-701-16	020-703-16
20,0 cm, 8"	020-701-20	020-703-20
24,0 cm, 9 ¹ / ₂ "	020-701-24	020-703-24
30,0 cm, 12"	020-701-30	020-703-30

Pinzetten mit Hartmetalleinlagen
 Forceps with tungsten carbide inserts
 Pinzas con bocas de carburo tungsteno
 Pinze con morsi in carburo di tungsteno



STANDARD

14,5 cm, 5 ³ / ₄ "	021-200-14
16,0 cm, 6 ¹ / ₄ "	021-200-16
18,0 cm, 7"	021-200-18
20,0 cm, 8"	021-200-20
25,0 cm, 10"	021-200-25
30,0 cm, 12"	021-200-30



STANDARD

14,0 cm, 5 ¹ / ₂ "	021-208-14
16,0 cm, 6 ¹ / ₄ "	021-208-16
18,0 cm, 7"	021-208-18
20,0 cm, 8"	021-208-20
25,0 cm, 10"	021-208-25
30,0 cm, 12"	021-208-30



STANDARD

12,5 cm, 5"	021-040-12
15,0 cm, 6"	021-040-15



STANDARD

15,0 cm, 6"	021-140-15
23,0 cm, 9"	021-140-23
25,0 cm, 10"	021-140-25



GILLIES
 15,0 cm, 6"
 021-300-15



MC INDOE
 15,0 cm, 6"
 021-158-15



GERALD
 17,0 cm, 6³/₄"

021-102-17

021-302-17



POTTS-SMITH
 15,0 cm, 6" **021-026-15**
 18,0 cm, 7" **021-026-18**
 20,0 cm, 8" **021-026-20**



BONNEY
 17,5 cm, 6⁵/₈"
 021-590-17



CUSHING
 17,5 cm, 6⁵/₈"



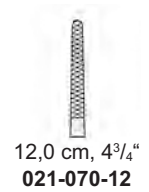
021-092-17



021-093-17



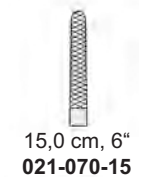
CUSHING-TAYLOR
 18,0 cm, 7"
 021-117-18



12,0 cm, 4³/₄"
021-070-12



12,0 cm, 4³/₄"
021-270-12



15,0 cm, 6"
021-070-15



15,0 cm, 6"
021-270-15



ADSON
 17,5 cm, 6⁵/₈"



SCHAEDEL
9,0 cm, 3 1/2"
030-101-09



ENGL. MODELL
9,0 cm, 3 1/2"
030-109-09



JONES
5,0 cm, 2" 030-105-05
7,0 cm, 2 3/4" 030-105-07
9,0 cm, 3 1/2" 030-105-09



JONES
9,0 cm, 3 1/2"
030-107-09

mit Schlauch- oder Kabelhalter
with clip for tubing or cable
con porta-tubo o porta-cable
con porta-tubo o porta-cavo



BACKHAUS
9,0 cm, 3 1/2" 030-000-09
11,0 cm, 4 3/8" 030-000-11
13,0 cm, 5" 030-000-13
15,0 cm, 6" 030-000-15



11,0 cm, 4 3/8"
030-005-11



ROEDER
13,0 cm, 5"
030-010-13



ROEDER
15,0 cm, 5"
030-010-15

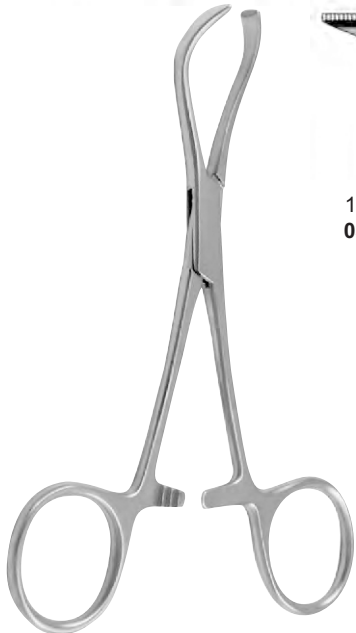


BERNHARD
16,5 cm, 6½"
030-044-16



Kugel / Pfanne
Ball / Socket
Bola / Cojinete
Palla / Cuscinetto

13,0 cm, 5"
030-024-13



LORNA



10,0 cm, 4"
030-014-10



13,0 cm, 5"
030-014-13

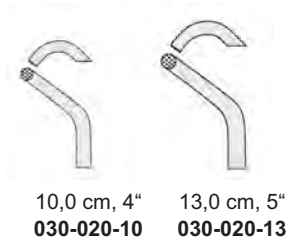


LANE

15,0 cm, 6"	030-040-15
18,0 cm, 7"	030-040-18
20,0 cm, 8"	030-040-20



TOHOKU



PEERS
 14,5 cm, 5³/₄"
 030-030-14



LISTER

13,0 cm, 5"	030-360-13
16,0 cm, 6 ¹ / ₄ "	030-360-16
18,0 cm, 7"	030-360-18



BRYANT
 13,0 cm, 5"
 030-351-13



BOZEMANN
 26,0 cm, 10¹/₄"
 030-320-26



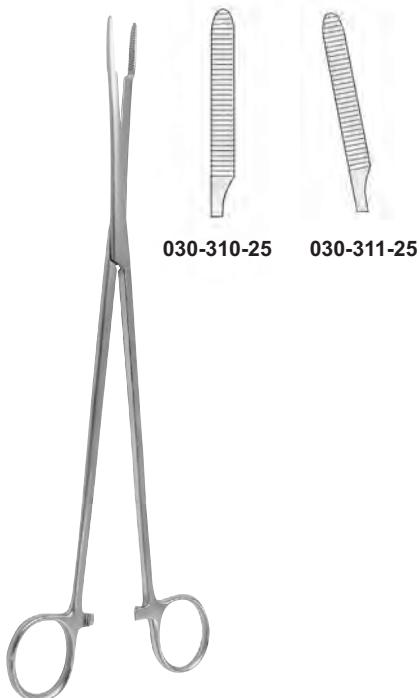
BOZEMANN
26,0 cm, 10¹/₄"
030-321-26



COLLIN
25,0 cm, 9³/₄"
030-300-25



CHERON
25,0 cm, 9³/₄"
030-303-25

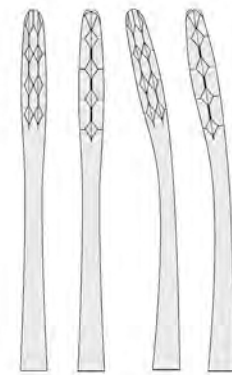


PELKMANN
25,0 cm, 9³/₄"

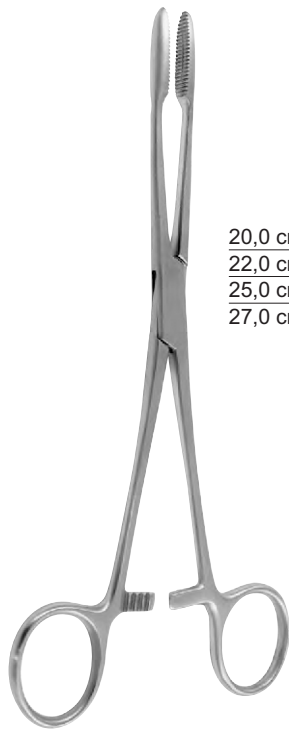
030-310-25 030-311-25



ULRICH

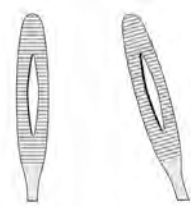


22,0 cm, 8⁵/₈" 030-200-22 030-201-22
25,0 cm, 9³/₄" 030-200-25 030-201-25
27,0 cm, 10⁵/₈" 030-200-27 030-201-27



GROSS-MAIER

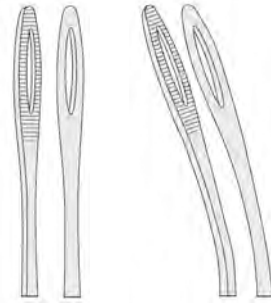
20,0 cm, 8"	030-210-20	030-211-20
22,0 cm, 8 ⁵ / ₈ "	030-210-22	030-211-22
25,0 cm, 9 ³ / ₄ "	030-210-25	030-211-25
27,0 cm, 10 ⁵ / ₈ "	030-210-27	030-211-27



FOERSTER

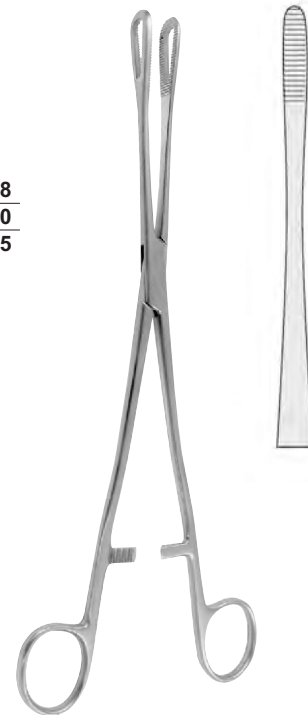
25,0 cm, 9³/₄"
030-180-25

25,0 cm, 9³/₄"
030-181-25



FOERSTER-BALLENGER

18,0 cm, 7"	030-160-18	030-161-18	030-170-18	030-171-18
20,0 cm, 8"	030-160-20	030-161-20	030-170-20	030-171-20
25,0 cm, 9 ³ / ₄ "	030-160-25	030-161-25	030-170-25	030-171-25



RAMPLEY

18,0 cm, 7" **030-190-18**
 25,0 cm, 9³/₄" **030-190-25**



PRESBYTERIAN

16,5 cm, 6½" 032-012-16
18,0 cm, 7" 032-012-18
20,0 cm, 8" 032-012-20



BERLIN

14,5 cm, 5¾" 032-006-14



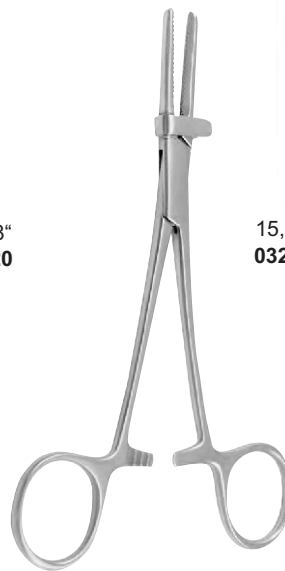
15,0 cm, 6" 032-002-15



18,0 cm, 7" 032-002-18



20,0 cm, 8" 032-002-20



15,0 cm, 6" 032-004-15



18,0 cm, 7" 032-004-18



20,0 cm, 8" 032-004-20

Bulldogklemmen
 Bulldog Clamps
 Clamps Bulldog
 Pinze Bulldog



3,5 cm, 1 1/2"	026-014-03	026-015-03
5,0 cm, 2"	026-014-05	026-015-05



DIEFFENBACH



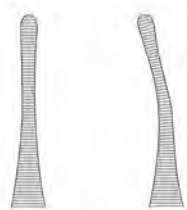
HESS
026-520-01



HESS
026-520-02



3,8 cm, 1 1/2"	026-018-04	026-019-04
5,0 cm, 2"	026-018-05	026-019-05
6,3 cm, 2 1/2"	026-018-06	026-019-06
7,6 cm, 3"	026-018-07	026-019-07
9,0 cm, 3 1/2"	026-018-09	026-019-09



JOHNS-HOPKINS



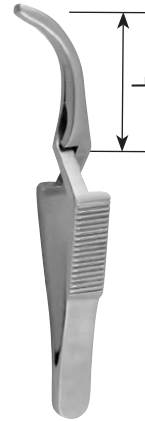
JOHNS-HOPKINS
23,0 cm, 9"
026-295-23



mit atraumatischer Riefung
with non-traumatic serration
con bocas atraumáticas
con presa atraumatica
с атравматичной зазубреностью

		L	
7,5 cm, 3"	026-292-07	2,5 cm, 1"	
8,5 cm, 3 1/4"	026-292-08	3,5 cm, 1 3/8"	
10,5 cm, 4 1/8"	026-292-10	5,0 cm, 2"	
12,0 cm, 4 3/4"	026-292-12	6,8 cm, 2 3/4"	

DE BAKEY



mit atraumatischer Riefung
with non-traumatic serration
con bocas atraumáticas
con presa atraumatica
с атравматичной зазубреностью

		L	
7,0 cm, 2 3/4"	026-293-07	2,5 cm, 1"	
8,0 cm, 3 1/8"	026-293-08	3,5 cm, 1 3/8"	
10,0 cm, 3 3/4"	026-293-10	5,0 cm, 2"	
11,5 cm, 4 1/2"	026-293-12	6,8 cm, 2 3/4"	

DE BAKEY



TITANIUM
3,5 cm, 1 3/8"
vena **027-032-35**
arteria **027-042-35**



TITANIUM
3,5 cm, 1 3/8"
vena **027-033-35**
arteria **027-043-35**

gerade
straight
recto
retto

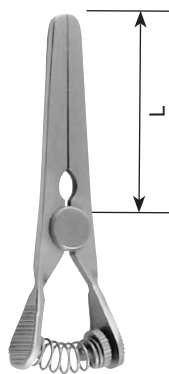


TITANIUM
4,0 cm, 1 5/8"
vena **027-032-40**
arteria **027-042-40**

gebogen
curved
curvo
curvo

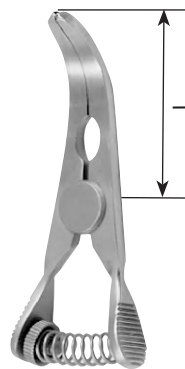


TITANIUM
4,0 cm, 1 5/8"
vena **027-033-40**
arteria **027-043-40**



GLOVER

		L	
6,8 cm, 2 3/4"	026-298-07	3,3 cm, 1 3/8"	
9,6 cm, 3 3/4"	026-298-09	5,0 cm, 2"	
11,7 cm, 4 3/4"	026-298-11	6,9 cm, 2 3/4"	



GLOVER

		L	
6,5 cm, 2 1/2"	026-299-06	3,3 cm, 1 3/8"	
9,1 cm, 3 1/2"	026-299-09	5,0 cm, 2"	
11,0 cm, 4 3/8"	026-299-11	6,9 cm, 2 3/4"	



CHAPUT
 13,0 cm, 5"
 040-370-13



TUFFIER
 13,0 cm, 5"
 040-372-13



COLLIN
 16,0 cm, 6 1/4"
 040-376-16



PENNINGTON
15,5 cm, 6" **040-358-15**
20,0 cm, 8" **040-358-20**



ATRAUMA



25,0 cm, 9³/₄"
040-658-25



27,0 cm, 10¹/₂"
040-658-27



MARTEL
14,0 cm, 5¹/₂"
040-364-14



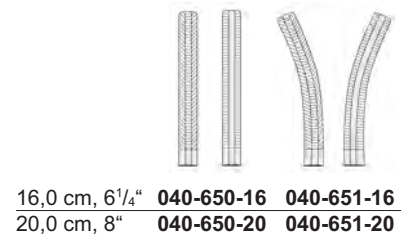
WILLET-MARTEL
19,0 cm, 7¹/₂"
040-366-19



PRATT
 15,0 cm, 6"
 040-656-15



FERGUSSON



16,0 cm, 6 ¹ / ₄ "	040-650-16	040-651-16
20,0 cm, 8"	040-650-20	040-651-20



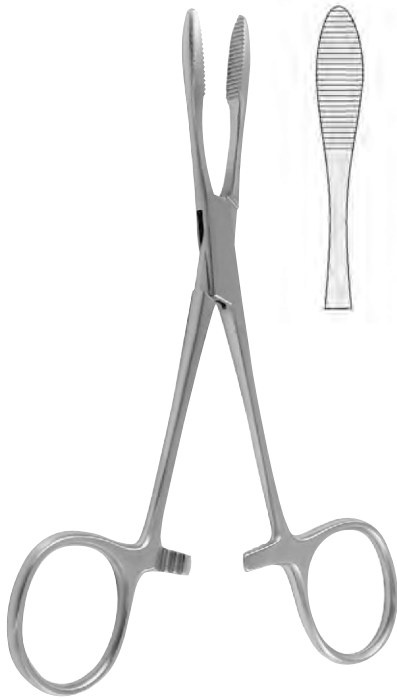
CARREL
 10,0 cm, 4"
 040-010-10



TERRIER
 10,0 cm, 4"
 040-016-10



KROENLEIN
 13,0 cm, 5"
 040-369-13



PEAN
14,0 cm, 5½" **040-368-14**
16,0 cm, 6¼" **040-368-16**



040-475-01

040-475-02

BABY-MIXTER
14,0 cm, 5½"



13,0 cm, 5"	040-290-13	040-291-13
15,0 cm, 6"	040-290-15	040-291-15
18,0 cm, 7"	040-290-18	040-291-18
20,0 cm, 8"	040-290-20	040-291-20

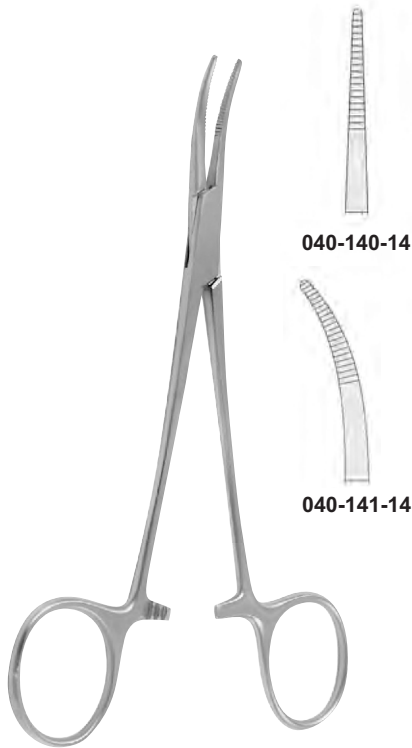
SPENCER-WELLS



040-000-10

040-001-10

HARTMANN
10,0 cm, 4"



040-140-14

040-141-14

PROVICENCE-HOSPITAL
 14,0 cm, 5 1/2"



HALSTED-MOSQUITO



12,5 cm, 5" **040-050-12** **040-051-12**
 14,0 cm, 9 3/4" **040-050-14** **040-051-14**

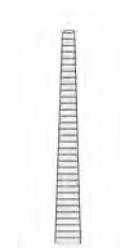
1 x 2 1 x 2



12,5 cm, 5" **040-070-12** **040-071-12**
 14,0 cm, 9 3/4" **040-070-14** **040-071-14**



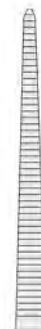
HALSTED-MOSQUITO



18,0 cm, 7"
040-050-18



18,0 cm, 7"
040-051-18

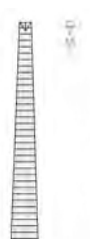


21,0 cm, 8 1/4"
040-050-21



21,0 cm, 8 1/4"
040-051-21

1 x 2



18,0 cm, 7"
040-070-18

1 x 2



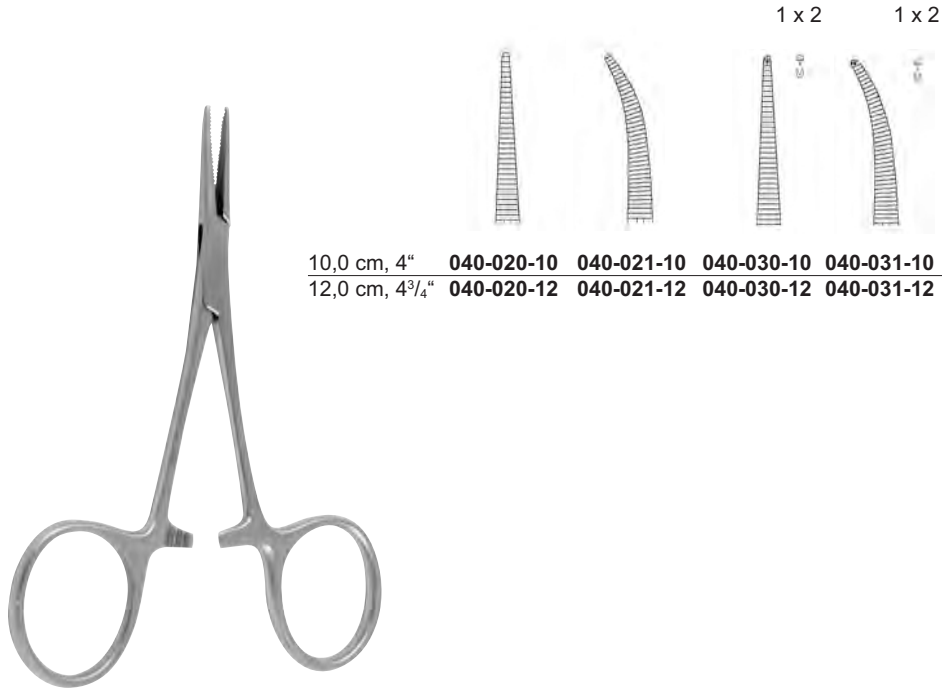
18,0 cm, 7"
040-071-18



21,0 cm, 8 1/4"
040-070-21

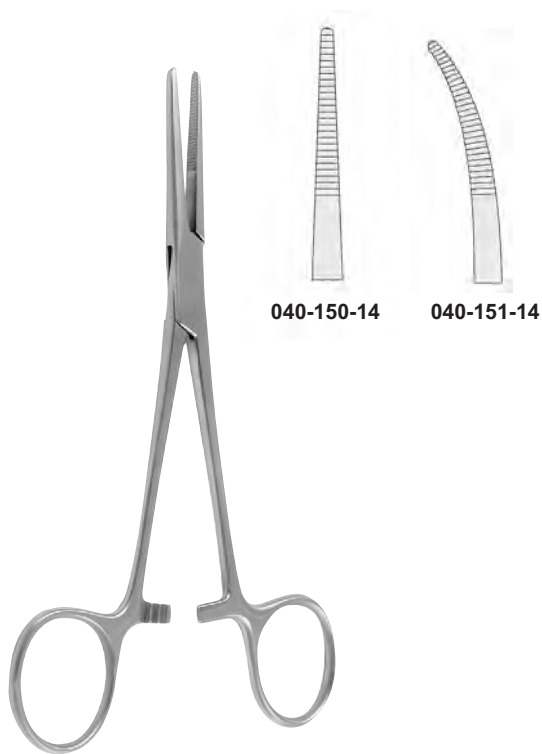


21,0 cm, 8 1/4"
040-071-21



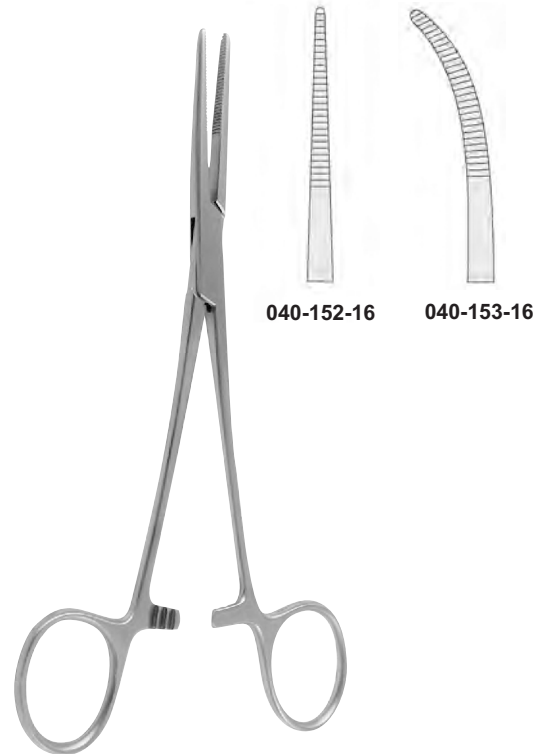
10,0 cm, 4" 040-020-10 040-021-10 040-030-10 040-031-10
12,0 cm, 4³/₄" 040-020-12 040-021-12 040-030-12 040-031-12

MICRO-MOSQUITO



040-150-14 040-151-14

KELLY
14,0 cm, 5¹/₂"

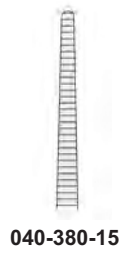


040-152-16 040-153-16

KELLY-RANKIN
16,0 cm, 6¹/₄"



LERICHE
 15,0 cm, 6"



BABY-OVERHOLT
 13,5 cm, 5 1/4"
 040-424-14

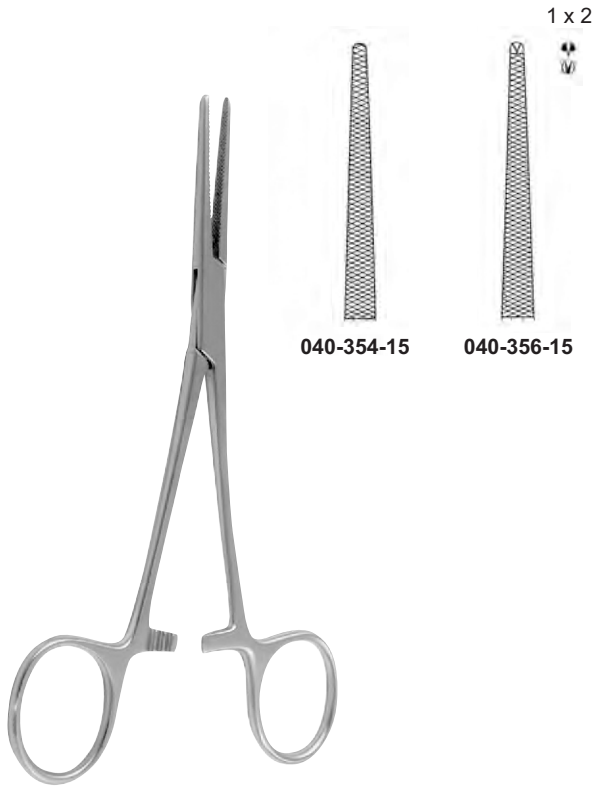


DANDY
 14,0 cm, 5 1/2"

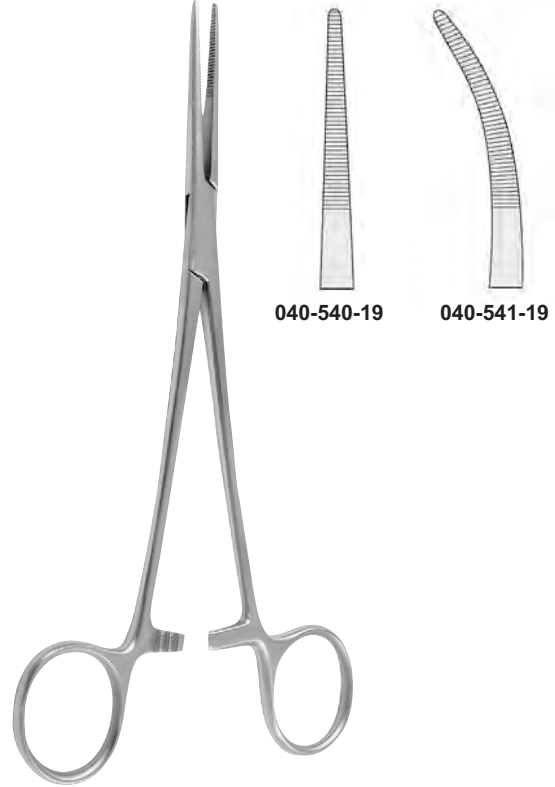


CRILE
 14,0 cm, 5 1/2"

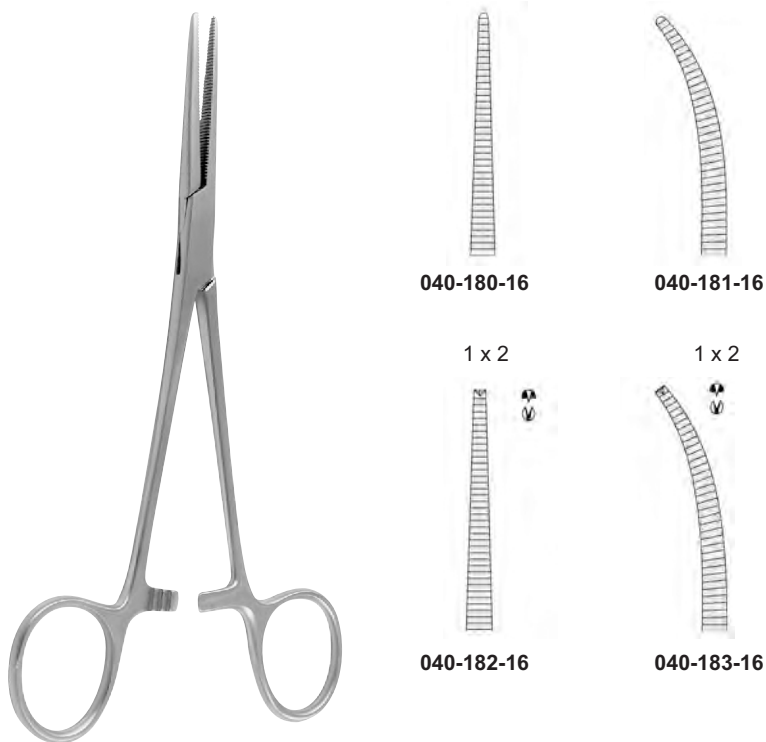




DIXON-LOVELACE
15,0 cm, 6"

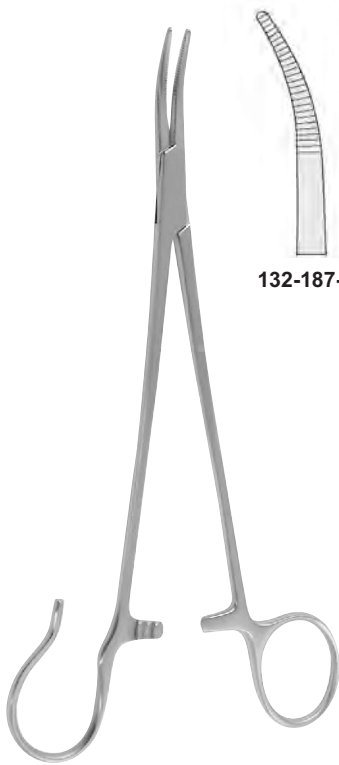


BIRKETT
19,0 cm, 7 1/2"

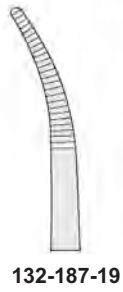


CRILE-RANKIN
16,0 cm, 6 1/4"

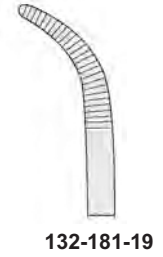
Arterienklemmen
 Haemostatic Forceps
 Pinzas hemostáticas
 Pinze emostatiche



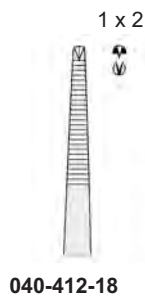
SCHNIDT
 19,0 cm, 7 1/2"



SCHNIDT-SAWTELL
 19,0 cm, 7 1/2"



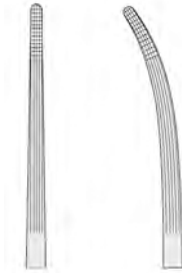
ADSON
 18,5 cm, 7 1/4"



CRAFOORD
 24,0 cm, 9 1/2"
 040-453-24



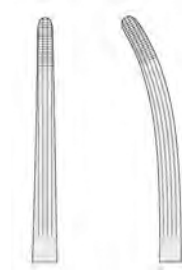
15,0 cm, 6"	040-480-15	040-481-15
18,5 cm, 7 1/4"	040-480-18	040-481-18



BAINBRIDGE



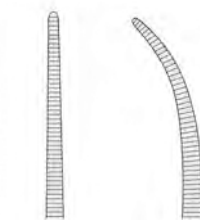
16,0 cm, 6 1/4"	040-340-16	040-341-16
20,0 cm, 8"	040-340-20	040-341-20



ROCHESTER-CARMALT



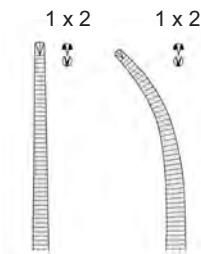
13,0 cm, 5"	040-262-13	040-263-13
14,0 cm, 5 1/2"	040-262-14	040-263-14
16,0 cm, 6 1/4"	040-262-16	040-263-16



PEAN DELICATE



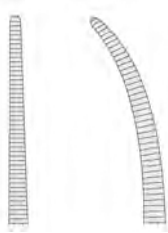
13,0 cm, 5"	040-352-13	040-353-13
14,0 cm, 5 1/2"	040-352-14	040-353-14
16,0 cm, 6 1/4"	040-352-16	040-353-16



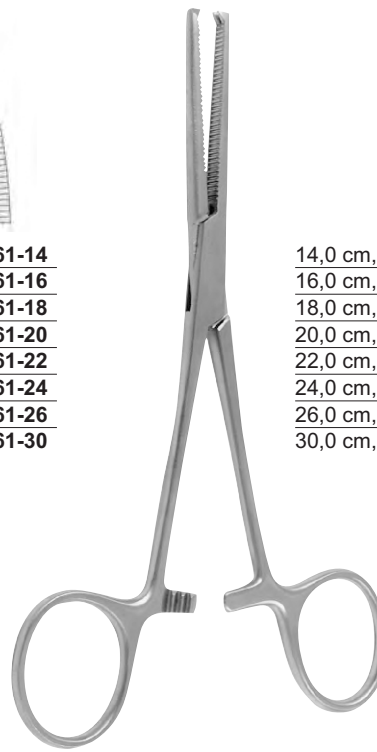
KOCHER DELICATE



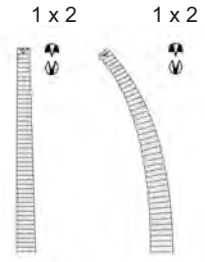
ROCHESTER-PEAN



14,0 cm, 5 1/2"	040-260-14	040-261-14
16,0 cm, 6 1/4"	040-260-16	040-261-16
18,0 cm, 7"	040-260-18	040-261-18
20,0 cm, 8"	040-260-20	040-261-20
22,0 cm, 8 5/8"	040-260-22	040-261-22
24,0 cm, 9 1/2"	040-260-24	040-261-24
26,0 cm, 10 1/4"	040-260-26	040-261-26
30,0 cm, 12"	040-260-30	040-261-30



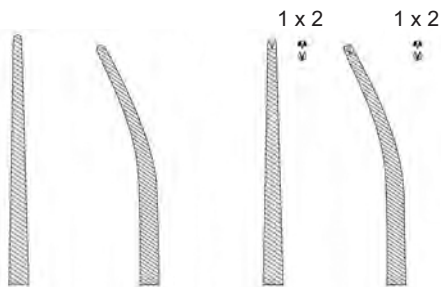
KOCHER-OCHSNER



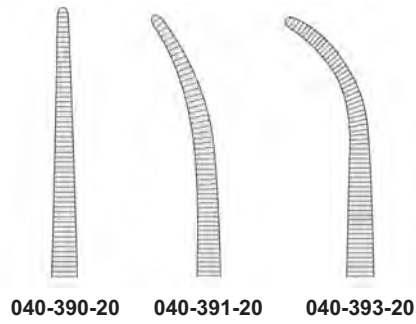
14,0 cm, 5 1/2"	040-350-14	040-351-14
16,0 cm, 6 1/4"	040-350-16	040-351-16
18,0 cm, 7"	040-350-18	040-351-18
20,0 cm, 8"	040-350-20	040-351-20
22,0 cm, 8 5/8"	040-350-22	040-351-22
24,0 cm, 9 1/2"	040-350-24	040-351-24
26,0 cm, 10 1/4"	040-350-26	040-351-26
30,0 cm, 12"	040-350-30	040-351-30



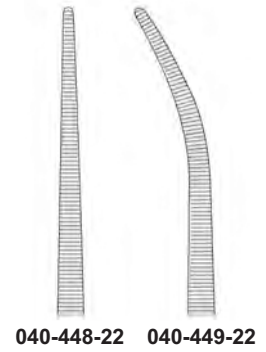
BENGOLEA



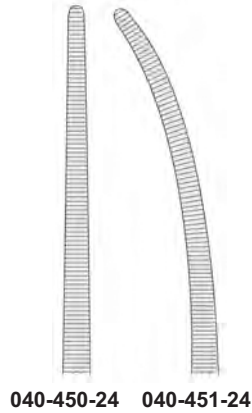
20,0 cm, 8"	040-384-20	040-385-20	040-386-20	040-387-20
26,0 cm, 10 1/4"	040-384-26	040-385-26	040-386-26	040-387-26



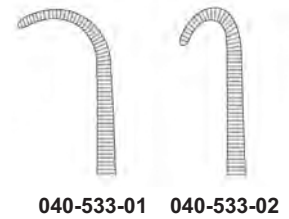
HEISS
20,0 cm, 8"



ROBERTS
22,0 cm, 8⁵/₈"



SAROT
24,0 cm, 9¹/₂"



NEGUS
19,0 cm, 7¹/₂"



BABY-ADSON



MICRO-ADSON
 14,0 cm, 5 1/2"
 040-409-14



BABY-MIXTER
 18,0 cm, 7"
 040-475-18



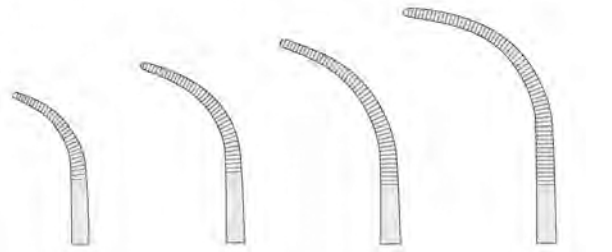
OVERHOLT-MIXTER
 21,0 cm, 8 1/4"
 040-471-21



JOHNS HOPKINS
 20,0 cm, 8"
 040-497-20



OVERHOLT



18,5 cm, 7 1/4"
040-423-01

20,0 cm, 8"
040-423-02

21,0 cm, 8 1/4"
040-423-03

21,5 cm, 8 1/2"
040-423-04



RUMEL
23,0 cm, 9"

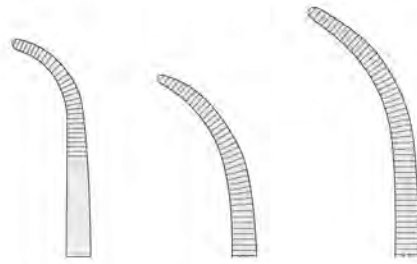


040-441-01

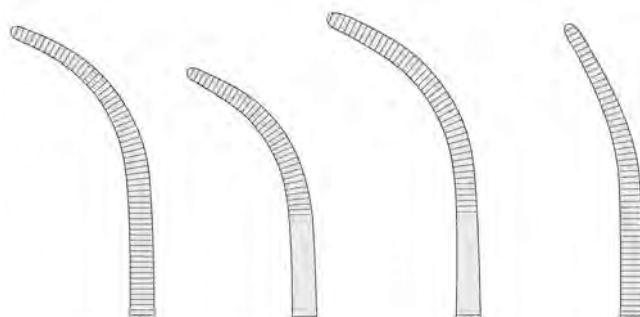
040-441-02

040-441-03

040-441-04



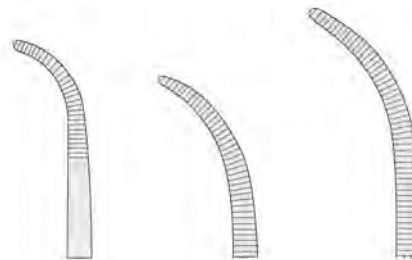
040-421-01 20,5 cm, 7³/₄"
040-421-02 20,0 cm, 7¹/₂"
040-421-03 21,5 cm, 8¹/₄"



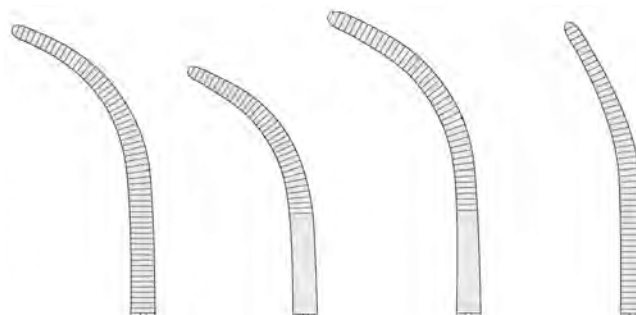
040-421-04 22,0 cm, 8³/₄"
040-421-05 21,5 cm, 8¹/₂"
040-421-06 22,0 cm, 8³/₄"
040-421-07 22,0 cm, 8³/₄"



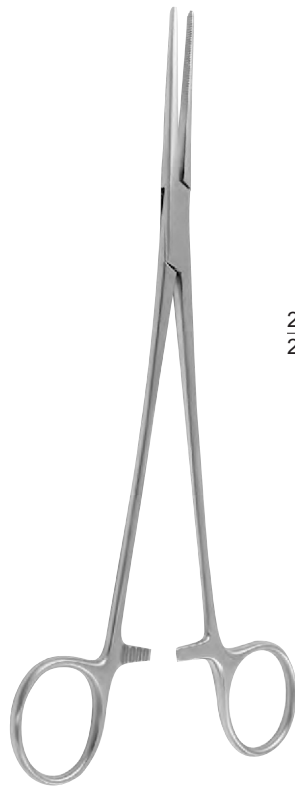
OVERHOLT-GEISSENDOERFER



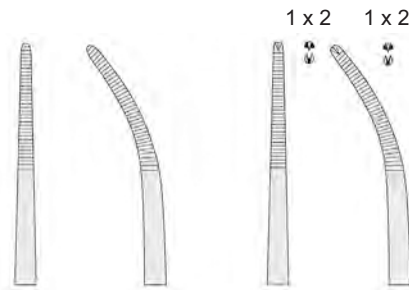
040-422-01 27,0 cm, 10³/₄"
040-422-02 26,0 cm, 10¹/₄"
040-422-03 27,0 cm, 10³/₄"



040-422-04 27,5 cm, 10³/₄"
040-422-05 27,5 cm, 10³/₄"
040-422-06 28,0 cm, 11"
040-422-07 28,0 cm, 11"



TOENNIS



21,0 cm, 8 ¹ / ₄ "	040-442-21	040-443-21	040-444-21	040-445-21
26,0 cm, 10 ¹ / ₄ "	040-442-26	040-443-26	040-444-26	040-445-26



KELLY



19,0 cm, 7 ¹ / ₂ "	040-463-19	040-465-19	040-467-19
22,0 cm, 8 ⁵ / ₈ "	040-463-22	040-465-22	040-467-22
24,0 cm, 9 ¹ / ₂ "	040-463-24	040-465-24	040-467-24



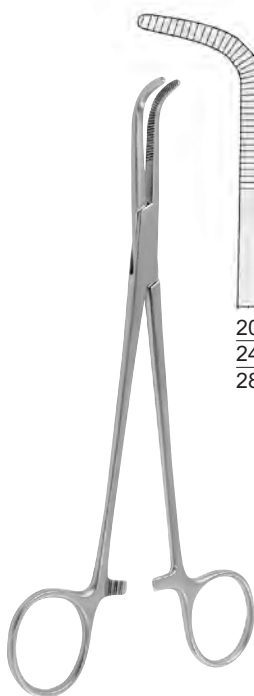
18,0 cm, 7"	040-429-18
22,0 cm, 8 ⁵ / ₈ "	040-429-22
25,0 cm, 9 ³ / ₄ "	040-429-25
28,0 cm, 11"	040-429-28

MINI-GEMINI



14,0 cm, 5 ¹ / ₂ "	040-431-14
16,0 cm, 6 ¹ / ₄ "	040-431-16
18,0 cm, 7"	040-431-18
20,0 cm, 8"	040-431-20
23,0 cm, 9"	040-431-23
25,0 cm, 9 ³ / ₄ "	040-431-25
28,0 cm, 11"	040-431-28

GEMINI



20,0 cm, 8"	040-433-20
24,0 cm, 9 ¹ / ₂ "	040-433-24
28,0 cm, 11"	040-433-28

KANTROWITZ



19,0 cm, 7 ¹ / ₂ "	040-543-19
21,0 cm, 8 ¹ / ₄ "	040-543-21
24,0 cm, 9 ¹ / ₂ "	040-543-24

WIKSTROEM



MIXTER
15,5 cm, 6" 040-461-15
19,0 cm, 7½" 040-461-19



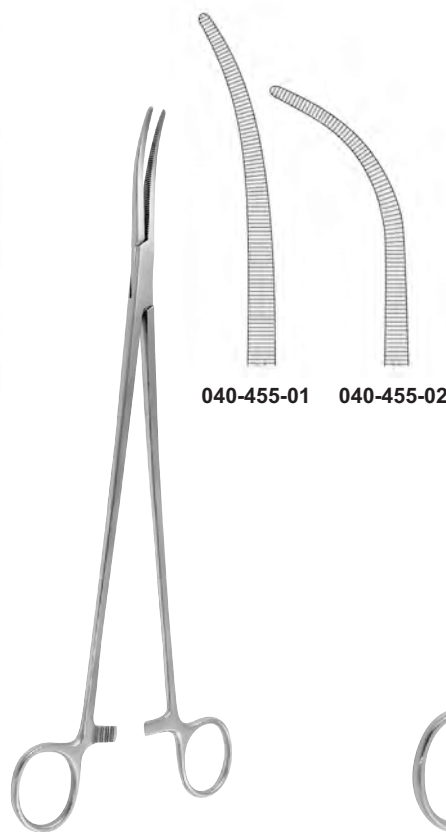
MIXTER-O'SHAUGNESSY
15,5 cm, 6" 040-477-15
19,0 cm, 7½" 040-477-19



MIXTER
22,0 cm, 8¾" 040-473-22



MIXTER
23,0 cm, 9" 040-473-23



ZENKER

040-455-01 040-455-02



ZENKER

040-459-18 040-459-28

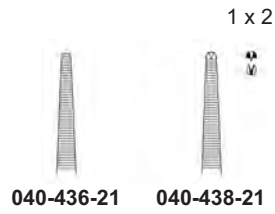
Präparier- und Ligaturklemmen
 Dissecting and Ligature Forceps
 Pinzas de disección y ligaduras
 Pinze per preparazioni e legature



LAWRENCE
 27,5 cm, 10³/₄"
 040-457-28



HOSEMANN
 21,0 cm, 8¹/₄"



DESJARDINS
 21,0 cm, 8¹/₄"
 040-529-21



MIXTER
 22,0 cm, 8³/₄" 040-479-22
 25,0 cm, 9³/₄" 040-479-25
 28,0 cm, 11" 040-479-28



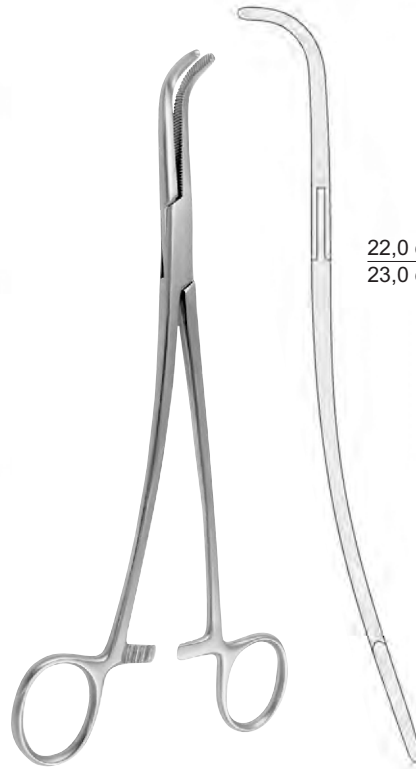
LAHEY
 19,0 cm, 7¹/₂" 040-501-19
 23,0 cm, 9" 040-501-23



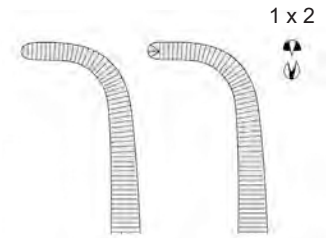
LOWER
 18,0 cm, 7"
 040-503-18



MC QUIGG-MIXTER
22,0 cm, 8³/₄"
040-507-22



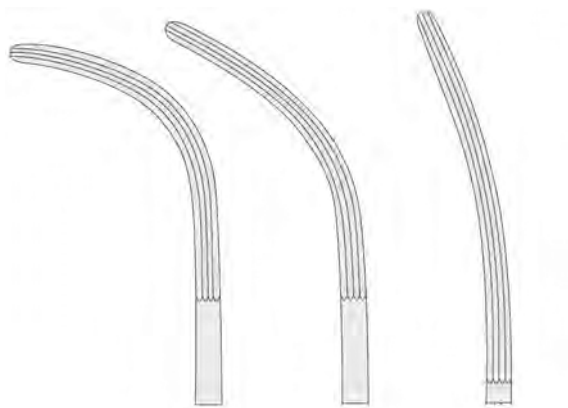
GRAY



22,0 cm, 8 ³ / ₄ "	040-523-22	040-525-22
23,0 cm, 9"	040-523-23	040-525-23



CRAFOORD-SELLORS



22,0 cm, 8 ³ / ₄ "	23,0 cm, 9"	24,0 cm, 9 ¹ / ₂ "
040-456-22	040-456-23	040-456-24



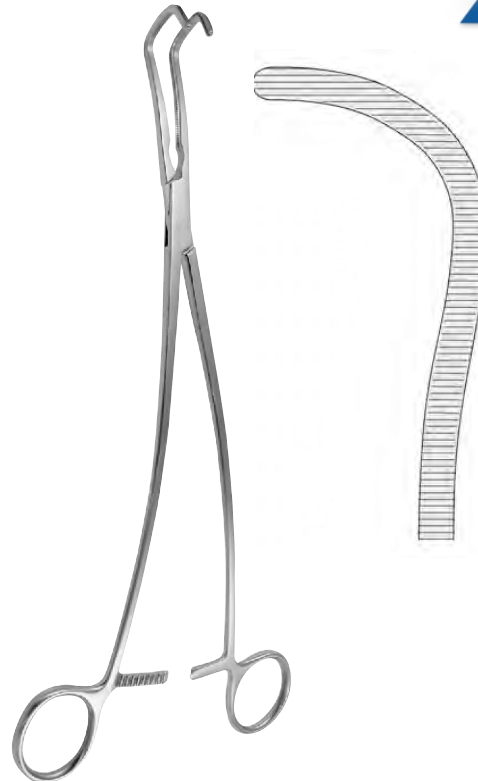
FINOCCHIETTO
24,0 cm, 9¹/₂"
040-505-24

Gallenkanal- und Nierenstielklemmen
 Gall Duct and Kidney Pedicle Clamps
 Pinzas-clamps para pedúnculo renal
 Pinze per peduncoli renali



GUYON

20,0 cm, 8" **040-509-20**
 22,0 cm, 8³/₄" **040-509-22**
 24,0 cm, 9¹/₂" **040-509-24**

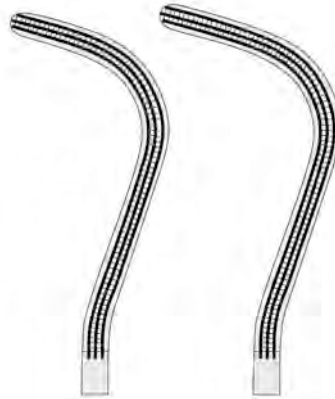


GUYON

23,0 cm, 9"
040-513-23



GUYON



23,0 cm, 9"
158-519-23

24,0 cm, 9¹/₂"
158-519-24



STILLE
 23,0 cm, 9"
040-511-23



HERRICK
23,0 cm, 9"
040-517-23



URO-TANGENTIAL

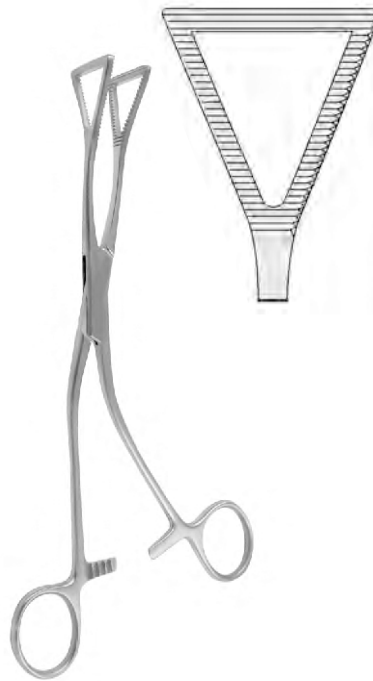


23,0 cm, 9"
170-055-01

24,0 cm, 9½"
170-055-02



LOVELACE
20,0 cm, 8"
141-004-20



LOVELACE
20,0 cm, 8"
141-005-20



PRICE-THOMAS
22,0 cm, 8¾"
141-001-22

Bronchusklemmen, Peritoneumklemmen, Hysterektomieklemmen
 Bronchus Forceps, Peritoneum Forceps, Hysterectomy Forceps
 Pinzas-clamps para bronquios, Pinzas-clamps para peritoneo y para histerectomía
 Pinze per legature, Pinze per peritoneo e per isterectomia



PRICE-THOMAS
 22,0 cm, 8³/₄"



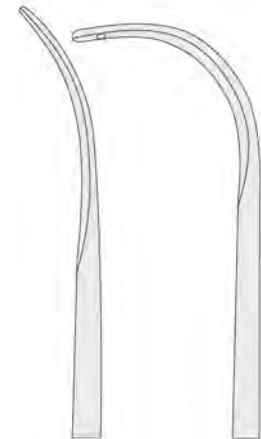
141-002-01



141-002-02



SEMB
 24,0 cm, 9¹/₂"



141-003-01

141-003-02



BABY-MIKULICZ
 14,0 cm, 5¹/₂"
 040-701-14

1 x 2



MIKULICZ
 18,0 cm, 7"
 040-703-18

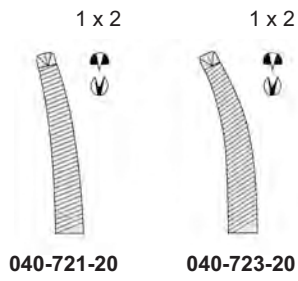
1 x 2



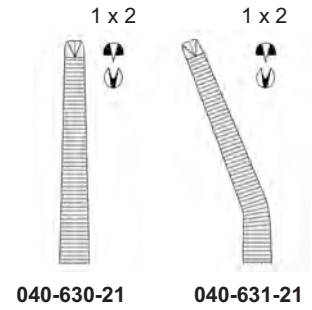
MIKULICZ
 20,0 cm, 8"
 040-709-20

1 x 2

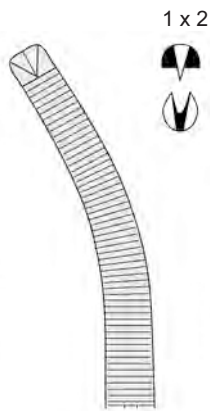
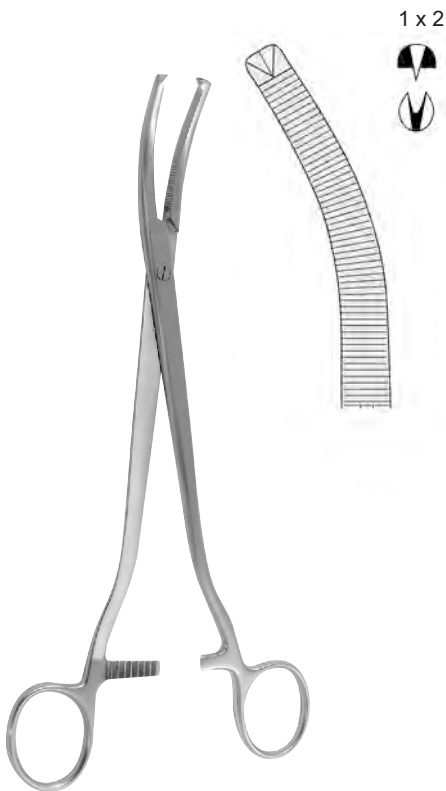




FAURE
20,0 cm, 8"



PHANEUF
21,5 cm, 8½"

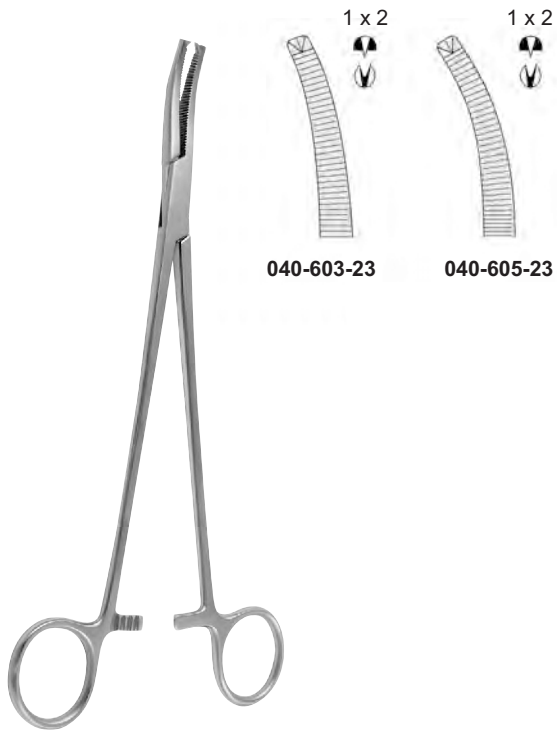


WERTHEIM
24,0 cm, 9½"

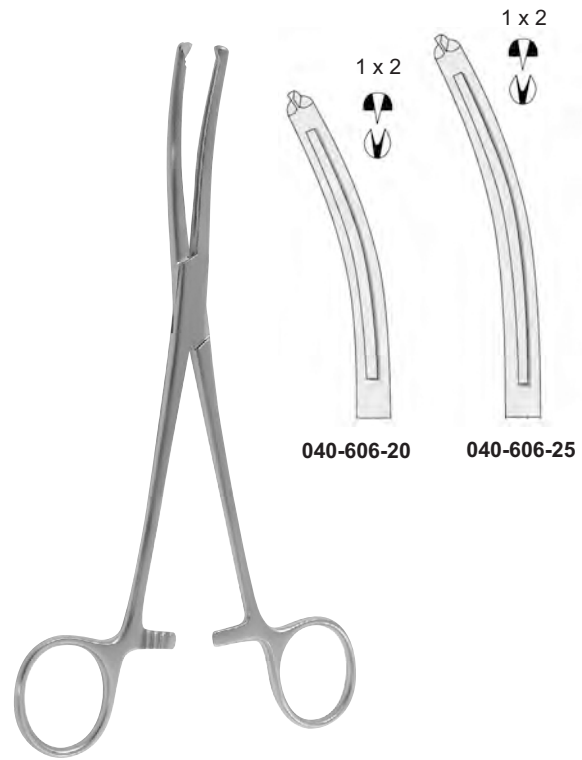


WERTHEIM
25,0 cm, 10"

Hysterektomieklemmen
 Hysterectomy Forceps
 Pinzas-clamps para histerectomía
 Pinze per isterectomia



WERTHEIM
 23,0 cm, 9"



MAINGOT
 21,5 cm, 8 1/2"



MOYNIHAN

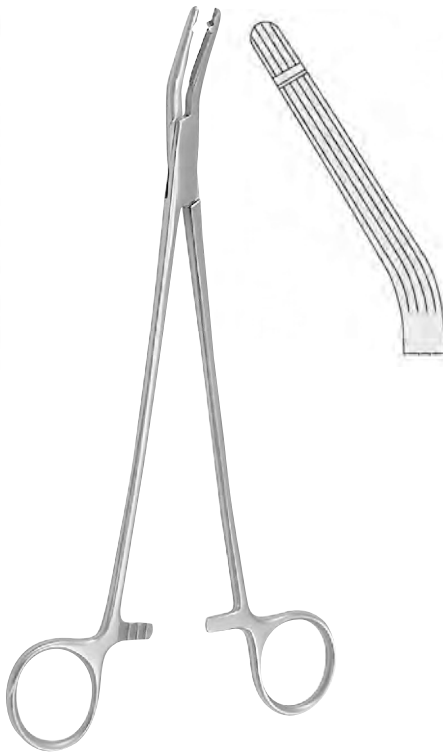


WERTHEIM-CULLEN
 21,5 cm, 8 1/2"
 040-629-21

1 x 2



LONG
19,0 cm, 7 1/4"
040-621-19



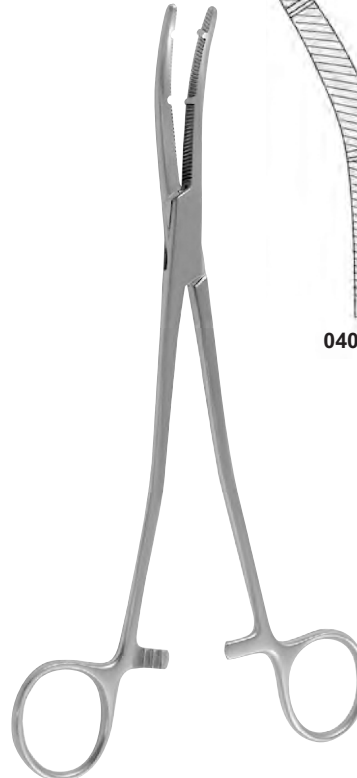
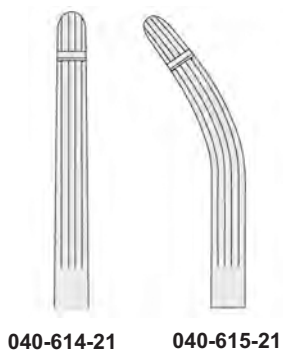
GARLAND
21,0 cm, 8 1/4"
040-623-21



HEANEY
21,0 cm, 8 1/4"
040-607-21



HEANEY-BALLANTINE
21,0 cm, 8 1/4"



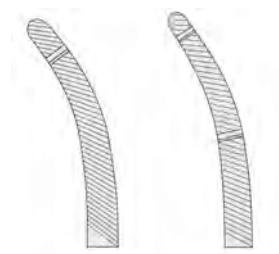
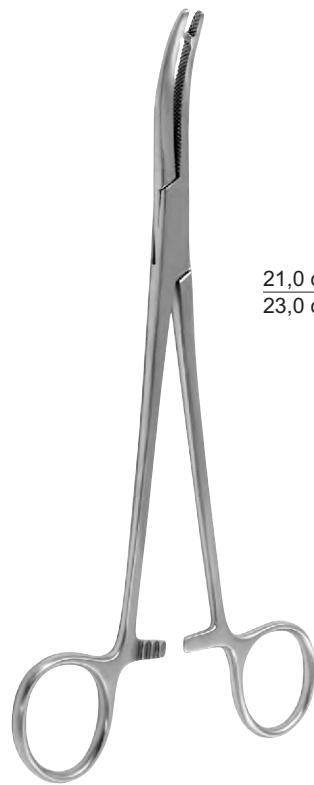
HEANEY-KANTER
21,0 cm, 8 1/4"

040-614-21

040-615-21

040-617-21

Hysterektomieklemmen
Hysterectomy Forceps
Pinzas-clamps para hysterectomía
Pinze per isterectomia



21,0 cm, 8 ¹ / ₄ "	040-611-21	040-613-21
23,0 cm, 9"	040-611-23	040-613-23

HEANEY



DERF



050-010-12
12,0 cm, 4³/₄"



050-020-12
12,5 cm, 5"



COLLIER
12,5 cm, 5"
050-022-12



WEBSTER
13,0 cm, 5"
050-028-13



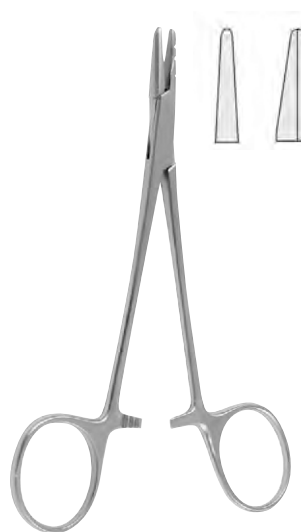
HALSEY
13,0 cm, 5"



050-030-13



050-040-13



NEIVERT
13,0 cm, 5"
050-046-13



HEGAR-BAUMGARTNER
14,0 cm, 5¹/₂"
050-048-14





050-096-13
13,0 cm, 5"

BROWN

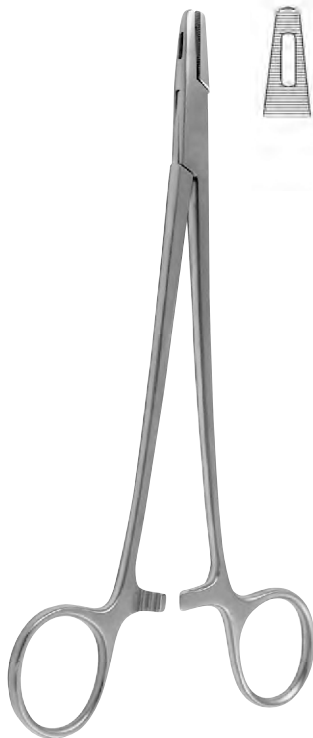


CRILE-MURRAY
15,0 cm, 6"
050-070-15



050-060-15
15,0 cm, 6"

CRILE-WOOD



ADSON
18,0 cm, 7"
050-192-18



METZENBAUM
18,0 cm, 7"
050-190-18



MASS.-GENERAL-HOSPITAL
17,0 cm, 6³/₄"
050-072-17



MAYO-HEGAR



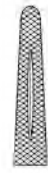
050-080-14
14,0 cm, 5½"



050-080-16
16,0 cm, 6¼"



050-080-18
18,0 cm, 7"



050-080-20
20,0 cm, 8"



050-080-24
24,0 cm, 9½"



050-080-26
26,0 cm, 10¼"



050-080-30
30,0 cm, 12"



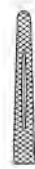
MAYO-HEGAR-DELICATE



050-090-16
16,0 cm, 6¼"



050-090-18
18,0 cm, 7"



050-090-20
20,0 cm, 8"



LAWRENCE
15,0 cm, 6"
050-110-15



HEANEY
21,0 cm, 8¹/₄"
050-141-21



JAMISON
23,5 cm, 9¹/₄"
050-148-23



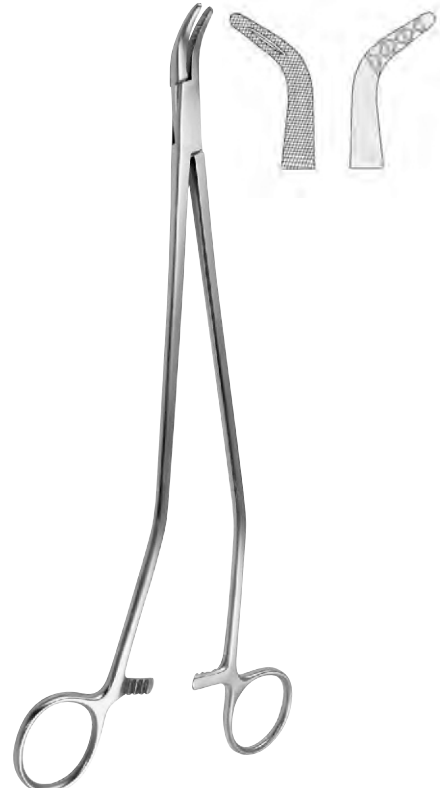
MASSON
27,0 cm, 10¹/₂"
050-150-27



FINOCCHIETTO
27,0 cm, 10¹/₂"
050-211-27



WANGENSTEEN
27,0 cm, 10¹/₂"
050-160-27



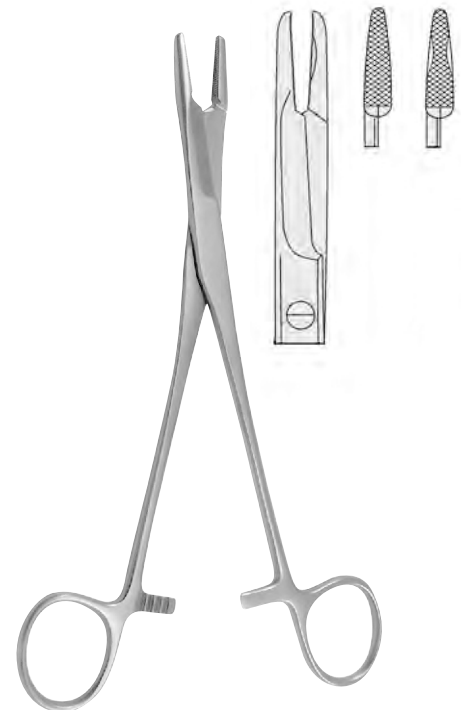
JOHNSON
27,0 cm, 10¹/₂"
050-193-27



STRATTE
23,0 cm, 9"
050-230-23



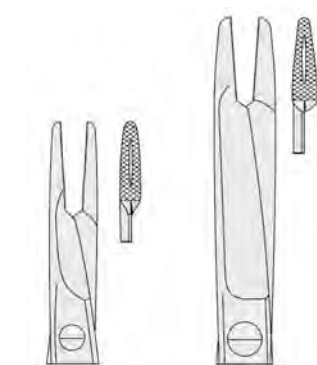
OLSEN-HEGAR
17,0 cm, 6³/₄"
050-310-17



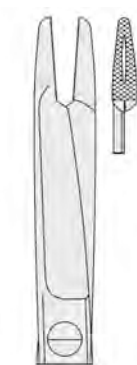
OLSEN-HEGAR
14,0 cm, 5¹/₂"
050-306-14



OLSEN-HEGAR



14,0 cm, 5¹/₂"
050-310-14



18,0 cm, 7"
050-310-18



TOENNIS
18,0 cm, 7"
050-362-18



050-350-14
14,0 cm, 5½"



050-350-17
17,0 cm, 6¾"



050-350-20
20,0 cm, 8"



050-356-17
17,0 cm, 6¾"



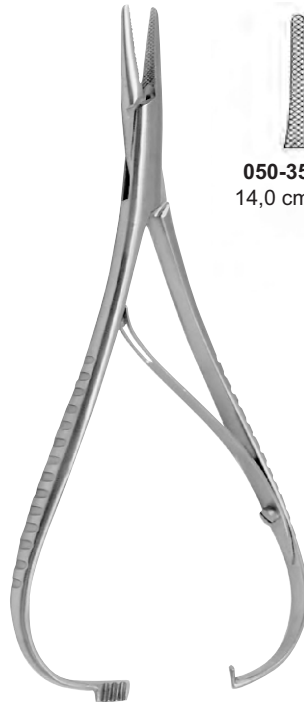
050-356-20
20,0 cm, 8"

MATHIEU

MATHIEU



LICHTENBERG
20,0 cm, 8"
050-366-20



050-354-14
14,0 cm, 5½"



050-354-17
17,0 cm, 6¾"

MATHIEU

Nadelhalter, Mikro-Nadelhalter
 Needle Holders, Micro Needle Holders
 Porta-agujas, Micro Porta-agujas
 Portaghi, Micro Portaghi



050-358-14
 14,0 cm, 5 1/2"



050-358-17
 17,0 cm, 6 3/4"



050-358-20
 20,0 cm, 8"



050-550-10



050-551-10



MATHIEU-KOCHER

BARRAQUER-TROUTMAN
 10,0 cm, 4"



050-553-10 **050-553-13**



BARRAQUER



BARRAQUER
 13,5 cm, 5 3/8"
050-621-13



GOMEL
 14,0 cm, 5 1/2"
050-601-14



050-600-18 050-601-18

ohne Sperre
without ratchet
sin cremallera
senza cremagliera

18,5 cm, 7 1/4"



050-630-18 050-631-18

mit Sperre
with ratchet
con cremallera
con cremagliera

18,5 cm, 7 1/4"



050-570-14 050-571-14

050-576-14 050-577-14

mit Sperre
with ratchet
con cremallera
con cremagliera

CASTROVIEJO
14,5 cm, 5 3/4"



050-570-18 050-571-18

050-576-18 050-577-18

mit Sperre
with ratchet
con cremallera
con cremagliera

CASTROVIEJO
18,0 cm, 7"

gerade, ohne Sperre
 straight, without ratchet
 recta, sin cremallera
 retta, senza cremagliera

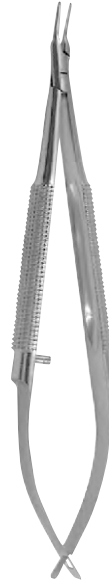
0,4 mm



14,0 cm, 5 1/2"
050-650-14

gebogen, ohne Sperre
 curved, without ratchet
 curva, sin cremallera
 curva, senza cremagliera

0,4 mm



14,0 cm, 5 1/2"
050-651-14

gebogen, mit Sperre
 curved, with ratchet
 curva, con cremallera
 curva, con cremagliera

0,4 mm



14,0 cm, 5 1/2"
050-653-14

gebogen, ohne Sperre
 curved, without ratchet
 curva, sin cremallera
 curva, senza cremagliera

0,5 mm



14,0 cm, 5 1/2"
050-661-14

gebogen, mit Sperre
 curved, with ratchet
 curva, con cremallera
 curva, con cremagliera

0,5 mm



14,0 cm, 5 1/2"
050-663-14

Ø 10 mm

gebogen, ohne Sperre
 curved, without ratchet
 curva, sin cremallera
 curva, senza cremagliera

0,4 mm



13,0 cm, 5"
050-671-13

Ø 8 mm



KALT
 13,5 cm, 5³/₈"
 051-428-14



DIETRICH

- | | |
|---|-------------------|
| 16,0 cm, 5 ³ / ₈ " | 051-250-16 |
| 18,0 cm, 7" | 051-250-18 |
| 20,0 cm, 8" | 051-250-20 |
| 23,0 cm, 9" | 051-250-23 |
| 26,0 cm, 10 ¹ / ₄ " | 051-250-26 |



WEBSTER
 13,0 cm, 5"
 051-028-13



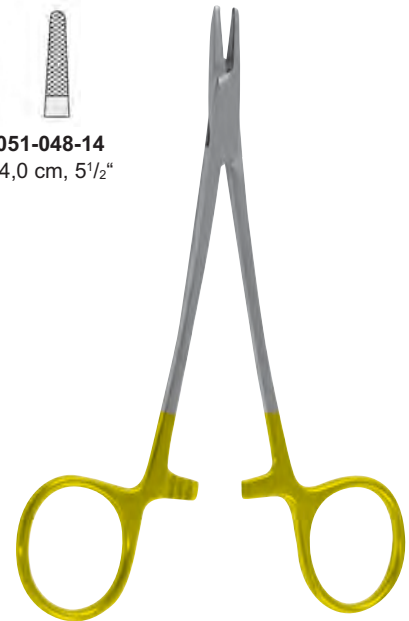
DERF
 12,0 cm, 4³/₄"
 051-010-12



HEGAR-BAUMGARTNER

051-048-12
 12,5 cm, 5"

051-048-14
 14,0 cm, 5¹/₂"



WEBSTER
 13,0 cm, 5"
 051-029-13

Nadelhalter mit Hartmetalleinlagen
 Needle Holders with tungsten carbide inserts
 Porta-agujas con bocas de carburo tungsteno
 Portaghi con morsi in carburo di tungsteno

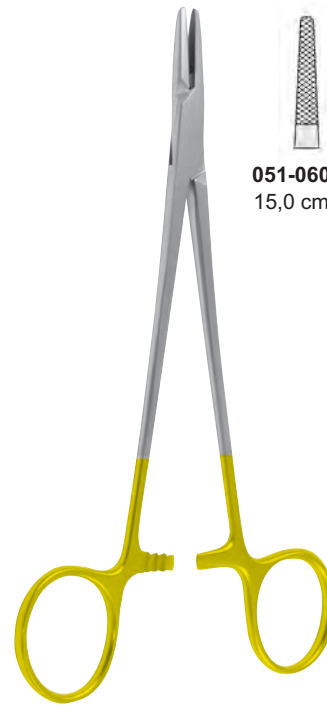


051-030-13



051-040-13

HALSEY
 13,0 cm, 5"

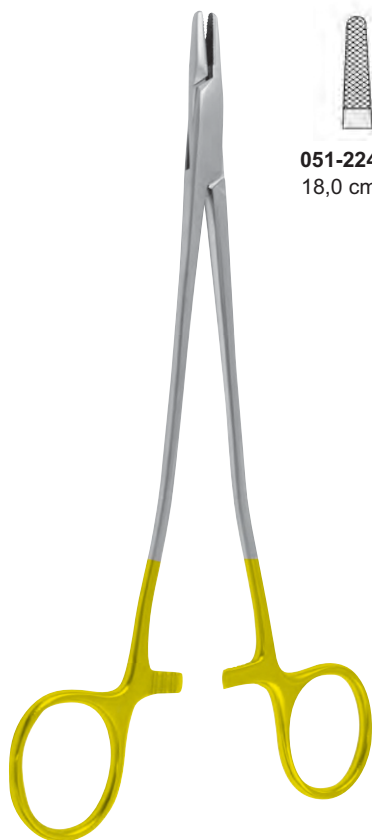


051-060-15
 15,0 cm, 6"



051-060-18
 18,0 cm, 7"

CRILE-WOOD



051-224-18
 18,0 cm, 7"



051-224-20
 20,0 cm, 8"



051-224-26
 26,0 cm, 10¹/₄"

SAROT



MAYO-HEGAR



051-080-16
16,0 cm, 6¹/₄"



051-080-18
18,0 cm, 7"



051-080-20
20,0 cm, 8"



051-080-24
24,0 cm, 9¹/₂"



051-080-26
26,0 cm, 10¹/₄"



051-080-30
30,0 cm, 12"



MAYO-HEGAR (HEANEY)



051-141-20
20,0 cm, 8"

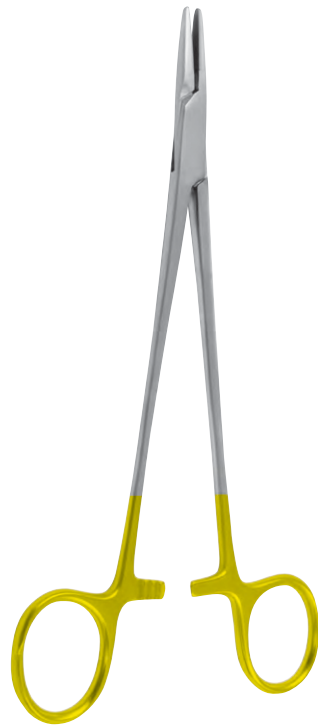


051-141-24
24,0 cm, 9¹/₄"



051-141-26
26,0 cm, 10¹/₄"

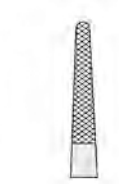
Nadelhalter mit Hartmetalleinlagen
 Needle Holders with tungsten carbide inserts
 Porta-agujas con bocas de carburo tungsteno
 Portaghi con morsi in carburo di tungsteno



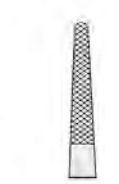
DE BAKEY



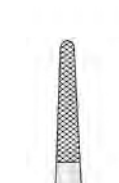
051-114-18
18,0 cm, 7"



051-114-20
20,0 cm, 8"



051-114-23
23,0 cm, 9"



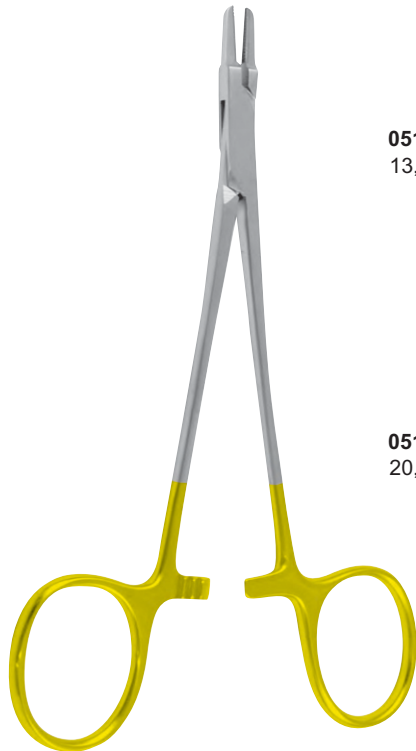
051-114-26
26,0 cm, 10¹/₄"



051-114-31
31,0 cm, 12¹/₄"



051-114-37
37,0 cm, 14¹/₂"



RYDER-VASCULAR



051-132-13
13,0 cm, 5"



051-132-15
15,0 cm, 6"



051-132-18
18,0 cm, 7"



051-132-20
20,0 cm, 8"



051-132-23
23,0 cm, 9"



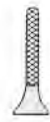
051-132-26
26,0 cm, 10¹/₄"



RYDER



051-134-13
13,0 cm, 5"



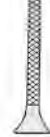
051-134-15
15,0 cm, 6"



051-134-18
18,0 cm, 7"



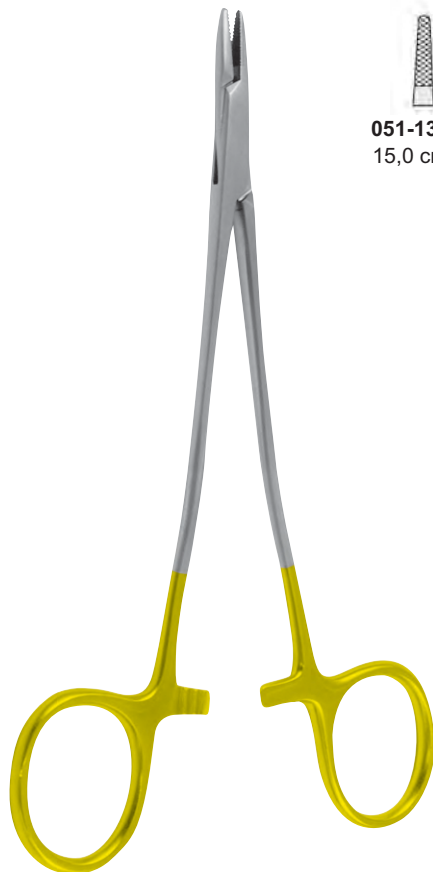
051-134-20
20,0 cm, 8"



051-134-23
23,0 cm, 9"



051-134-26
26,0 cm, 10 1/4"



SCHWEDISCHES MODELL



051-136-15
15,0 cm, 6"

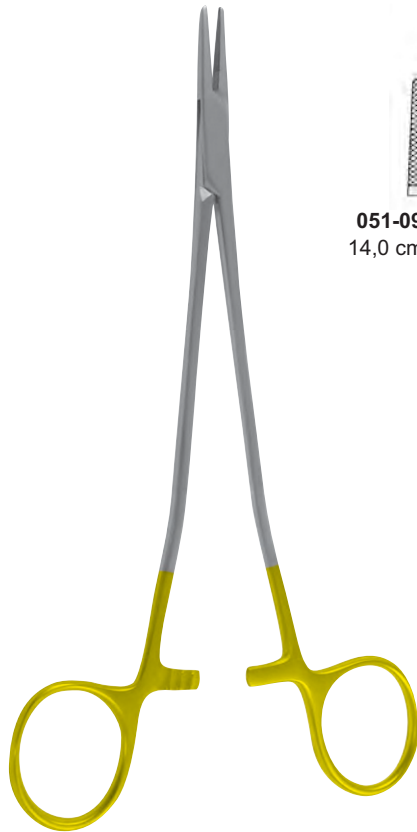


051-136-17
17,0 cm, 6 3/4"



051-136-20
20,0 cm, 8"

Nadelhalter mit Hartmetalleinlagen
 Needle Holders with tungsten carbide inserts
 Porta-agujas con bocas de carburo tungsteno
 Portaghi con morsi in carburo di tungsteno



051-090-14
 14,0 cm, 5½"



051-090-18
 18,0 cm, 7"



051-090-20
 20,0 cm, 8"



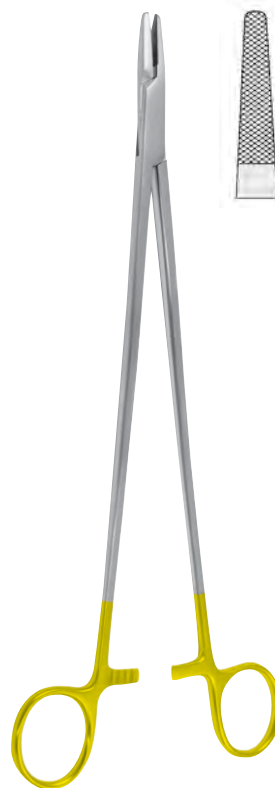
051-090-23
 23,0 cm, 9"



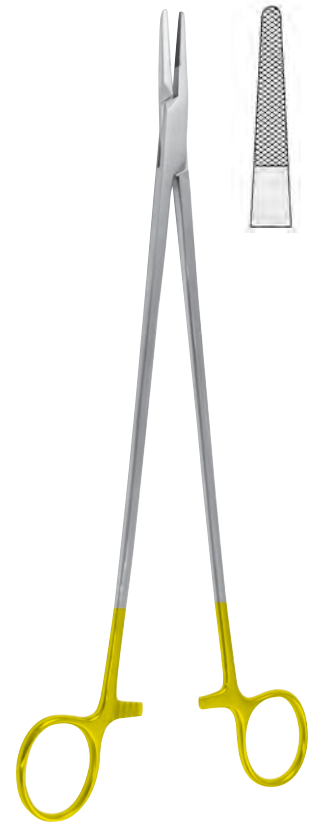
MAYO-HEGAR (HEANEY)



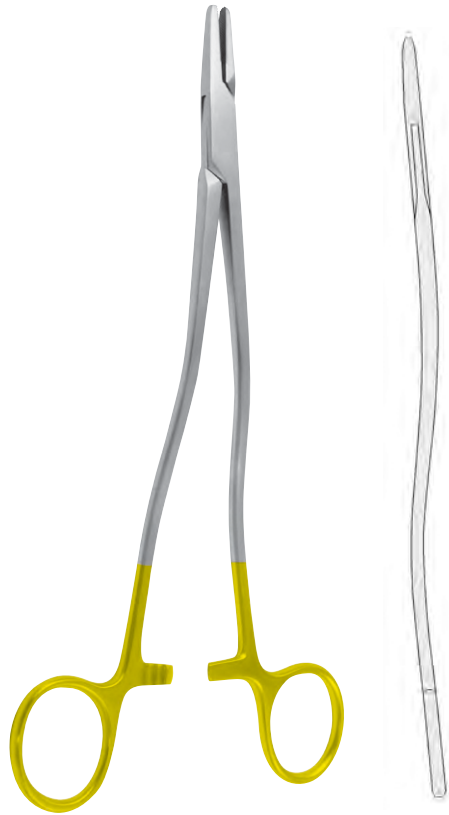
FINOCCHIETTO
 27,0 cm, 10½"
051-211-27



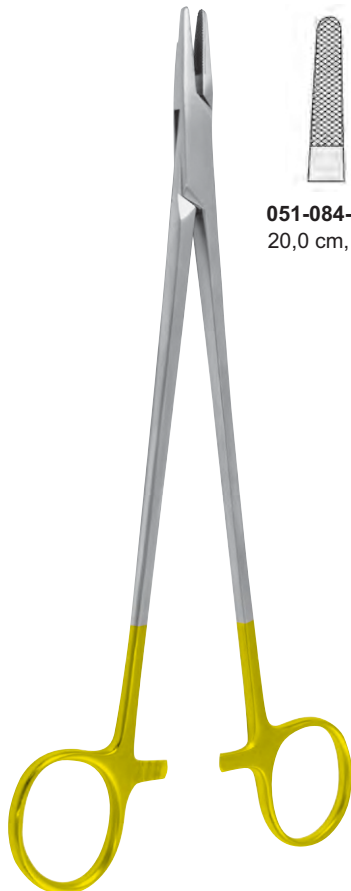
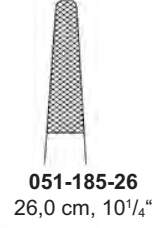
MASSON
 27,0 cm, 10½"
051-150-27



WANGENSTEEN
 27,0 cm, 10½"
051-160-27



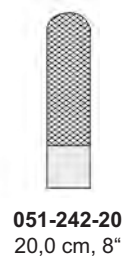
BOZEMANN



HEGAR



BARRY STERNAL



Nadelhalter mit Hartmetalleinlagen
 Needle Holders with tungsten carbide inserts
 Porta-agujas con bocas de carburo tungsteno
 Portaghi con morsi in carburo di tungsteno



STRATTE



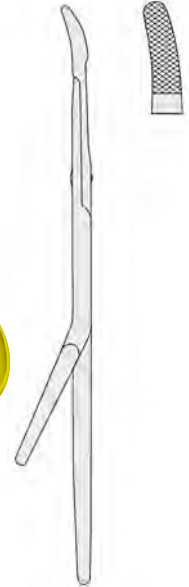
051-230-22
 22,0 cm, 8⁵/₈"



051-230-23
 23,0 cm, 9"



GILLIES
 16,0 cm, 6¹/₄"
051-330-16



OLSEN-HEGAR



051-310-14
 14,0 cm, 5¹/₂"



051-310-17
 17,0 cm, 6³/₄"



051-310-18
 18,0 cm, 7"



TOENNIS
 18,0 cm, 7"
051-362-18



MATHIEU-KOCHER



MATHIEU



Nadelhalter mit Hartmetalleinlagen
Needle Holders with tungsten carbide inserts
Porta-agujas con bocas de carburo tungsteno
Portaghi con morsi in carburo di tungsteno



LICHTENBERG



051-366-17
17,0 cm, 6³/₄"



051-366-20
20,0 cm, 8"



MATHIEU



051-356-17
17,0 cm, 6³/₄"



051-356-20
20,0 cm, 8"



051-356-23
23,0 cm, 9"



ZWEIFEL



051-364-20
20,0 cm, 8"



051-364-23
23,0 cm, 9"



LANGENBECK



051-360-18
18,0 cm, 7"

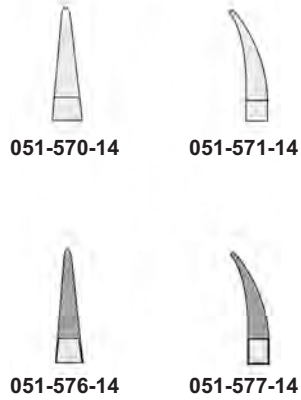


051-360-20
20,0 cm, 8"



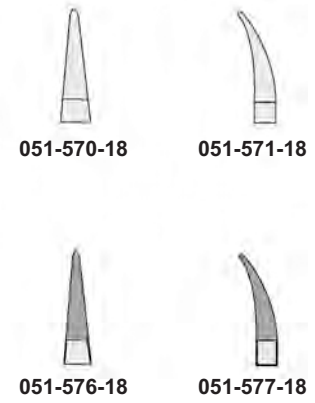
051-360-23
23,0 cm, 9"

Nadelhalter mit Hartmetalleinlagen
 Needle Holders with tungsten carbide inserts
 Porta-agujas con bocas de carburo tungsteno
 Portaghi con morsi in carburo di tungsteno



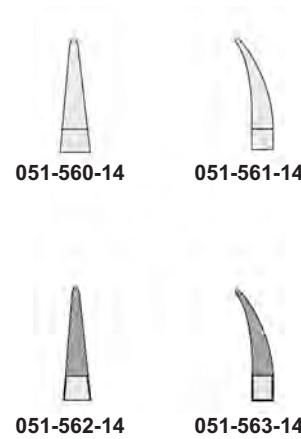
mit Sperre
 with ratchet
 con cremallera
 con cremagliera

CASTROVIEJO
 14,5 cm, 5³/₄"



mit Sperre
 with ratchet
 con cremallera
 con cremagliera

CASTROVIEJO
 18,0 cm, 7"



mit Sperre
 with ratchet
 con cremallera
 con cremagliera

BARRAQUER
 14,5 cm, 5³/₄"



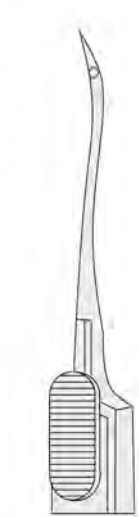
HEPP SCHEIDEL
 18,0 cm, 7"
 051-390-18



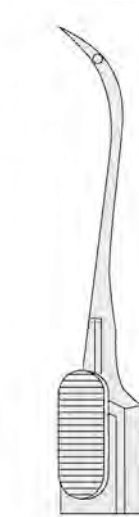
REVERDIN
14,0 cm, 5½"



056-211-01



056-211-02



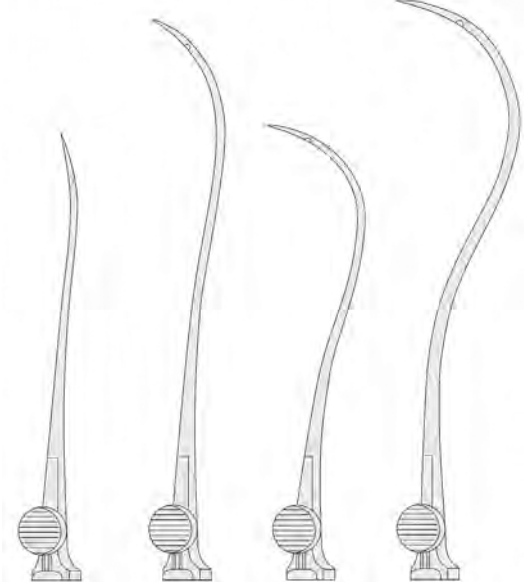
056-211-03



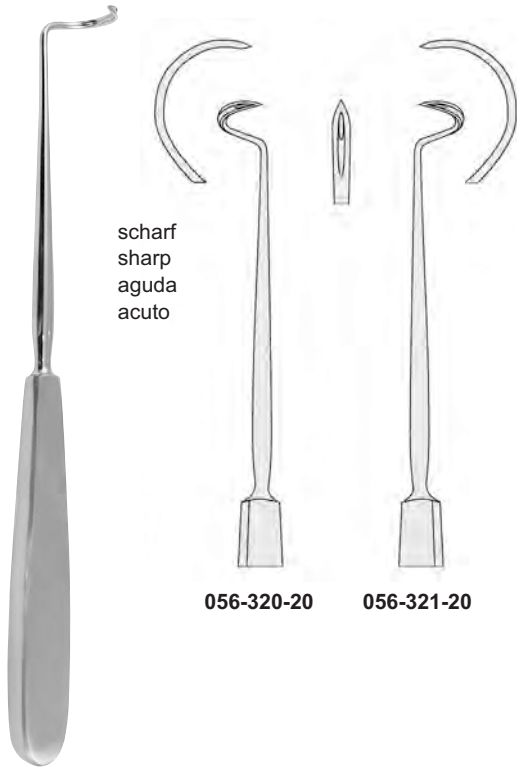
056-211-04



REVERDIN



19,5 cm, 7¾"	056-221-01	056-221-02	056-221-03	056-221-04
22,5 cm, 8¾"	056-223-01	056-223-02	056-223-03	056-223-04

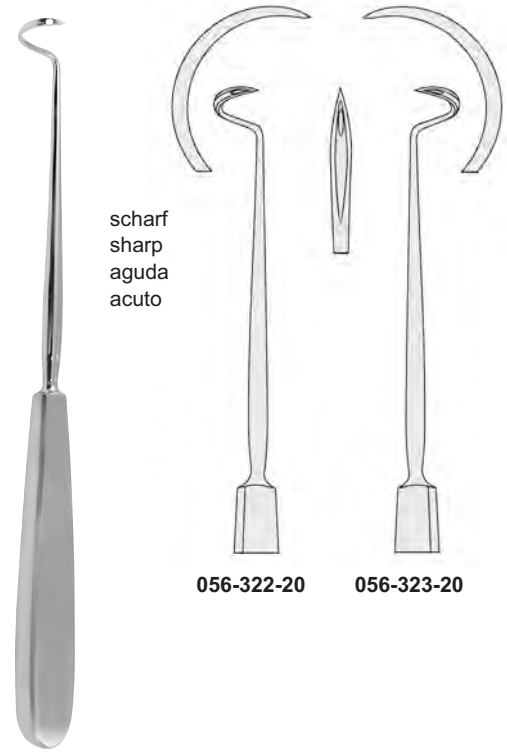


scharf
sharp
aguda
acuto

056-320-20

056-321-20

DESCHAMPS
20,0 cm, 8"

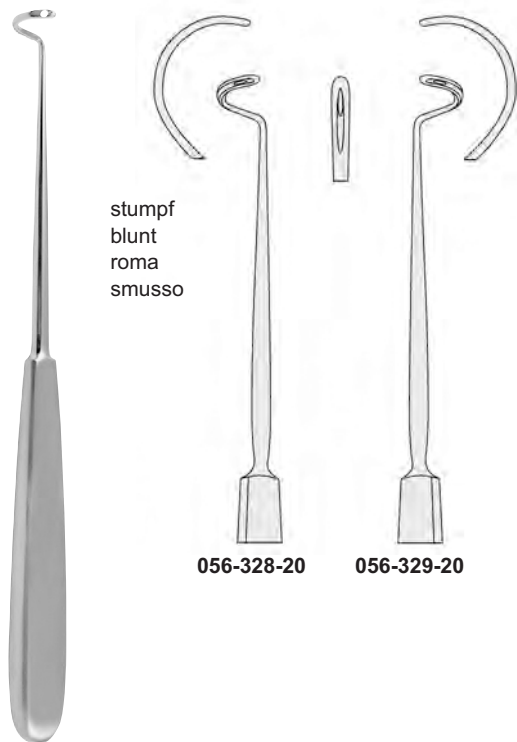


scharf
sharp
aguda
acuto

056-322-20

056-323-20

DESCHAMPS
20,0 cm, 8"

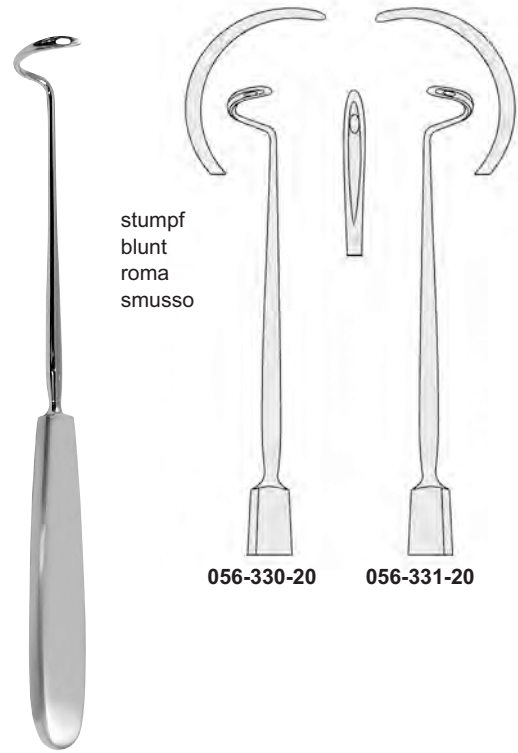


stumpf
blunt
roma
smusso

056-328-20

056-329-20

DESCHAMPS
20,0 cm, 8"



stumpf
blunt
roma
smusso

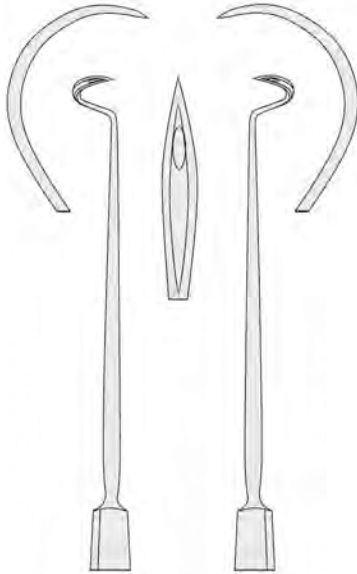
056-330-20

056-331-20

DESCHAMPS
20,0 cm, 8"



scharf
sharp
aguda
acuto

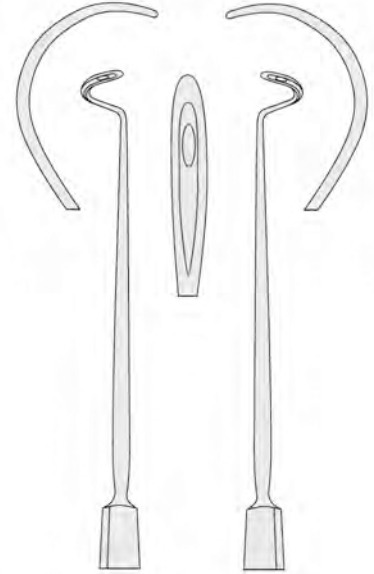


21,0 cm, 8¹/₄" 056-324-21 056-325-21
27,0 cm, 10⁵/₈" 056-324-27 056-325-27

DESCHAMPS



stumpf
blunt
roma
smusso



21,0 cm, 8¹/₄" 056-332-21 056-333-21
27,0 cm, 10⁵/₈" 056-332-27 056-333-27

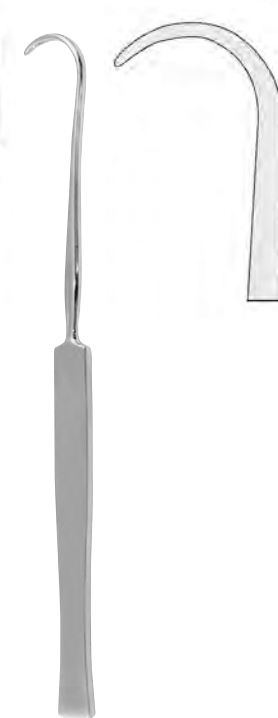
DESCHAMPS



20,0 cm, 8"
056-450-20



biegsam
malleable
maleable
malleabile



COOPER
19,0 cm, 7¹/₂"
056-451-19



COOPER
20,0 cm, 8"
056-451-20



SYME
15,0 cm, 6"
056-453-15



Unterbindungsnadeln
Ligature Needles
Agujas para ligaduras
Aghi per legatura



056-452-01



056-452-02



056-452-03



BRUNNER
25,0 cm, 9³/₄"
056-455-25



056-454-01



056-454-02

BRUNNER
30,0 cm, 11³/₄"



SCHMIEDEN
21,0 cm, 8¹/₄"
056-458-21



YOUNG-HRYNTSCHAK
24,0 cm, 9 1/2"
056-460-24



056-460-01



056-460-02



056-460-03



DE LA ROZA
12,0 cm, 4 3/4"
056-467-01



DE LA ROZA
12,0 cm, 4 3/4"
056-467-02



JAKOBI
14,0 cm, 5 1/2"
056-469-14



HESSEBERG
15,0 cm, 6"
056-468-15



KRONECKER
15,0 cm, 6"
056-470-01

Unterbindungsnadeln
 Ligature Needles
 Agujas para ligaduras
 Aghi per legatura



KRONECKER
 15,0 cm, 6"
 056-470-02



TRELAT
 23,0 cm, 9"
 056-472-23



CLAUS
 23,0 cm, 9"
 056-473-23



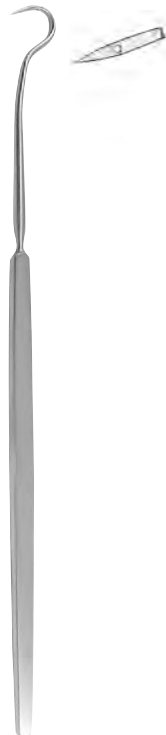
HURD
 21,0 cm, 8 1/4"
 056-474-01



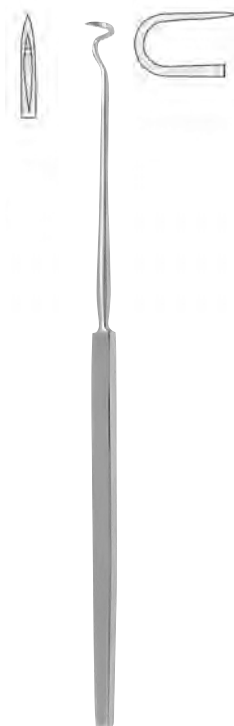
HURD
 21,0 cm, 8 1/4"
 056-474-02



NAGER
 24,0 cm, 9 1/2"
 056-477-24



CLAUS-EICKEN
 23,0 cm, 9"
 056-481-23



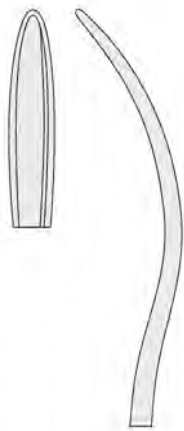
FALK
 24,0 cm, 9 1/2"
 056-480-01



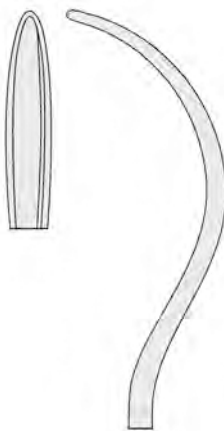
FALK
 24,0 cm, 9 1/2"
 056-480-02



BRUNNER
30,0 cm, 11³/₄"



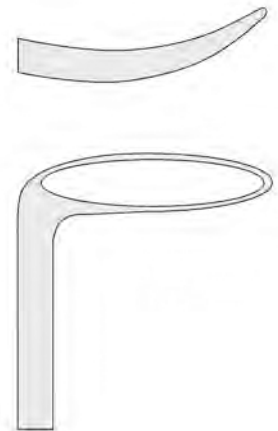
056-500-01



056-500-02



056-500-03



056-500-04



PAYR
 22,0 cm, 8⁵/₈"
 056-502-22



PAYR
 22,0 cm, 8⁵/₈"
 056-503-22



mit Loch
 with hole
 con foro
 con ago



SCHMIEDEN-PAYR
 19,0 cm, 7¹/₂"
 056-506-19



ohne Loch
 without hole
 sin foro
 senza ago



SCHMIEDEN
 19,0 cm, 7¹/₂"
 056-507-19



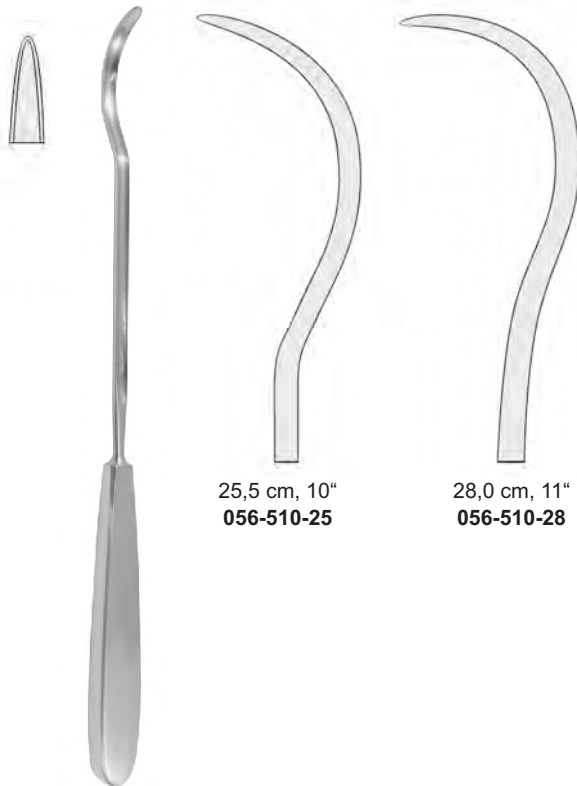
KÖNIG
 19,5 cm, 7³/₄"
 056-508-03



KÖNIG
 19,5 cm, 7³/₄"
 056-508-05



KÖNIG
 19,5 cm, 7³/₄"
 056-508-07



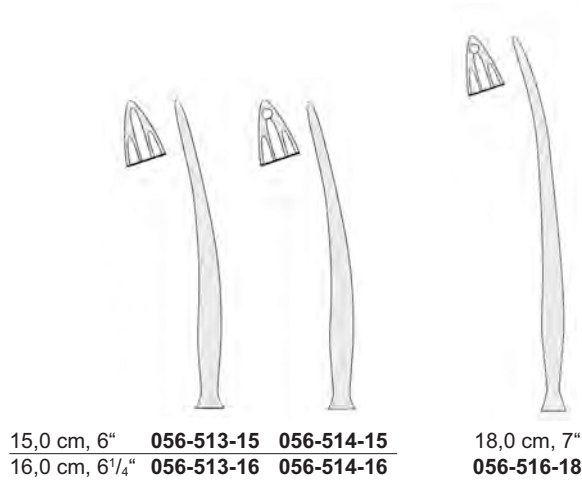
KIRSCHNER



BRUNNER-FERROZELL
18,0 cm, 7" **056-521-18**
27,0 cm, 10⁵/₈" **056-521-27**



KOCHER





MOD. WIEN
23,5 cm, 9¹/₄"
056-532-23



BOZEMANN
21,0 cm, 8¹/₄"
056-531-21



23,0 cm, 9"
056-530-23



MICHEL
12,0 cm, 4³/₄"
056-550-12



COLLIN
13,0 cm, 5"
056-552-13



RICHTER-HEATH
14,0 cm, 5¹/₂"
056-553-14



WACHENFELDT
12,5 cm, 5"
056-555-01



HEGENBARTH
12,5 cm, 5"
056-556-12



MICHEL
12,0 cm, 4³/₄"
056-558-12



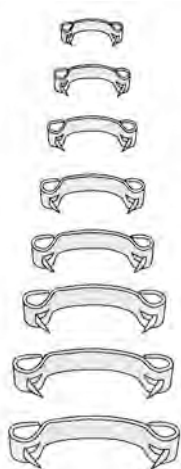
LANGE
10,0 cm, 4"
056-559-10



CHILDE
18,0 cm, 7"
056-560-01



CHILDE CLIP
18,0 cm, 7"
056-560-02



- 056-570-08 7,5 x 1,75 mm
- 056-570-11 11,0 x 2,0 mm
- 056-570-12 12,0 x 3,0 mm
- 056-570-14 14,0 x 3,0 mm
- 056-570-16 16,0 x 3,0 mm
- 056-570-18 18,0 x 3,0 mm
- 056-570-20 20,0 x 3,0 mm
- 056-570-22 22,0 x 3,0 mm

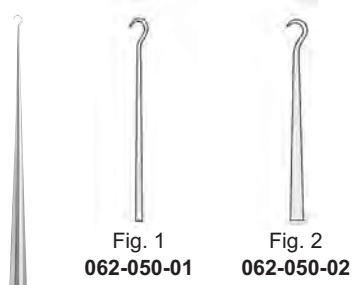
MICHEL



CLIP-SET
056-558-00

bestehend aus, consisting of,
compuesto de, composto da

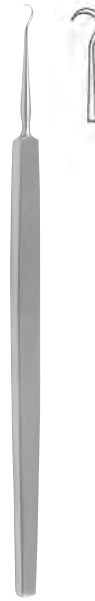
- 1 x 056-558-12
- 1 x 056-550-12
- 50 x 056-570-14
- 1 x 056-590-01 (Etui)



GILLIES
 18,0 cm, 7"



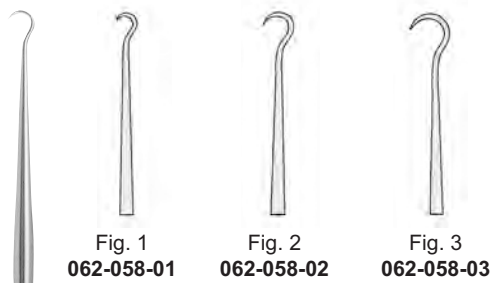
KILNER
 15,0 cm, 6"
 062-054-15



FRAZIER
 13,0 cm, 5"
 062-060-13



O'CONNOR
 16,0 cm, 6 1/4"
 062-074-16



KLEINERT-KUTZ
 16,0 cm, 6 1/4"



JOSEPH
 16,0 cm, 6 1/4"
 062-062-16



GRAEFE
 16,0 cm, 6 1/4"





Fig. 1
062-070-01



Fig. 2
062-070-02



Fig. 3
062-070-03



Fig. 4
062-070-04

16,0 cm, 6 1/4"



Fig. 1
062-080-01



Fig. 2
062-080-02



GUTHRIE
16,0 cm, 6 1/4"



Fig. 1
062-086-01



Fig. 2
062-086-02



Fig. 3
062-086-03



Fig. 4
062-086-04



JOSEPH
16,0 cm, 6 1/4"



Fig. 1
062-082-01

scharf
sharp
agudos
acuti

KNAPP
13,0 cm, 5"



Fig. 2
062-082-02

stumpf
blunt
romo
smusso



16,0 cm, 6 1/4"



062-088-02



062-088-03



062-088-04



062-089-02



062-089-03

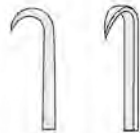


062-089-04

flexibel · flexible · flexibles · flessibili



16,0 cm, 6 1/4"



062-101-01



062-101-02

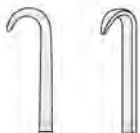


062-101-03



062-101-04

scharf
sharp
agudos
acuti



062-103-01



062-103-02



062-103-03



062-103-04

halbscharf
semi-sharp
semi-agudos
semi-acuti



062-102-01



062-102-02



062-102-03

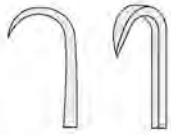


062-102-04

stumpf
blunt
romo
smusso



16,0 cm, 6 1/4"



062-111-01



062-111-02



062-111-03



062-111-04

scharf
sharp
agudos
acuti



062-112-01



062-112-02



062-112-03



062-112-04

stumpf
blunt
romo
smusso



CUSHING
19,0 cm, 7 1/2"



Fig. 1
062-140-01



Fig. 2
062-140-02



LANGENBECK-GREEN
16,0 cm, 6 1/4"

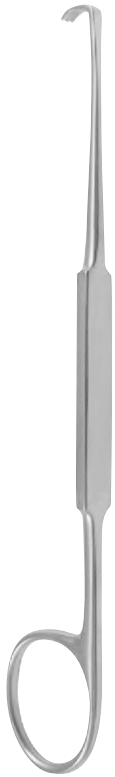


16 x 6 mm
062-162-01



24 x 6 mm
062-162-02

Wundhaken
Retractors
Separadores
Divaricatori



MEYERDING
18,0 cm, 7"



18 x 7 mm
062-150-01



16 x 5 mm
062-150-02



7 x 4 mm
062-150-03



10 x 3 mm
062-150-04



7 x 4 mm
062-150-05



4 x 10 mm
062-150-06



16,0 cm, 6 1/4"



14 x 8 mm
062-166-16



SENN-GREEN
15,0 cm, 6"



10 x 6 mm
062-160-10



20 x 6 mm
062-160-20



MINI-LANGENBECK
16,0 cm, 6 1/4"



10 x 6 mm
062-164-01



17 x 5 mm
062-164-02



20 x 6 mm
062-164-03



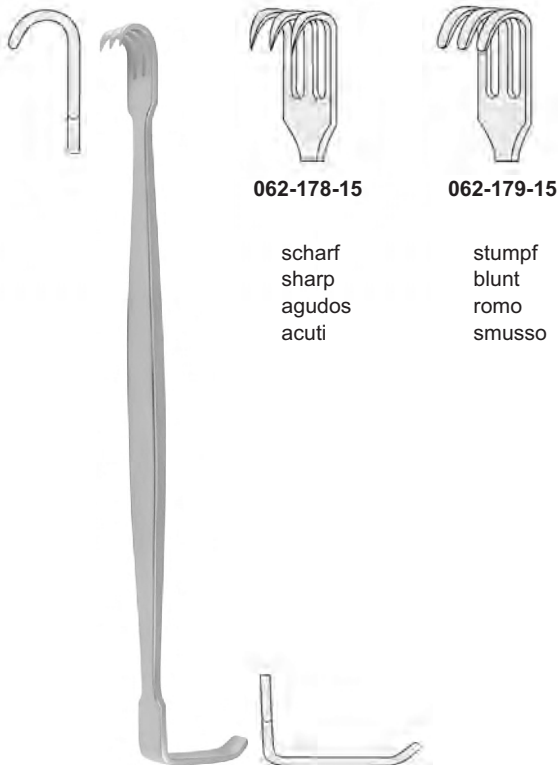
22 x 8 mm
062-164-04



RAGNELL-DAVIS
14,0 cm, 5 1/2"
062-170-14



RAGNELL
15,0 cm, 6"
062-174-15



BABY SENN-MILLER
15,0 cm, 6"

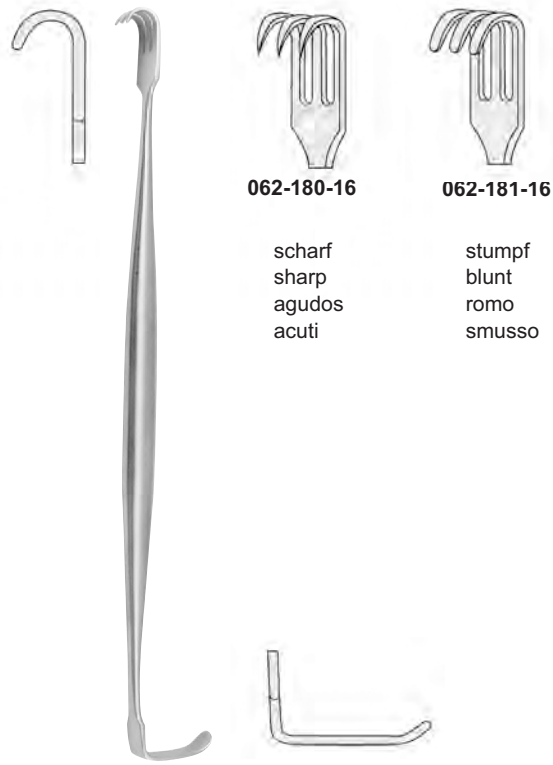
062-178-15

scharf
sharp
agudos
acuti



062-179-15

stumpf
blunt
romo
smusso



SENN-MILLER
16,0 cm, 6 1/4"

062-180-16

scharf
sharp
agudos
acuti



062-181-16

stumpf
blunt
romo
smusso



8 mm
062-200-08



10 mm
062-200-10



12 mm
062-200-12



14 mm
062-200-14



16 mm
062-200-16



18 mm
062-200-18

DESMARRES
13,0 cm, 5"



8 mm
062-204-08



10 mm
062-204-10



12 mm
062-204-12



14 mm
062-204-14



16 mm
062-204-16



18 mm
062-204-18

DESMARRES
16,0 cm, 6 1/4"



CUSHING
20,0 cm, 8"



8 mm
062-210-08



10 mm
062-210-10



12 mm
062-210-12



14 mm
062-210-14



16 mm
062-210-16



18 mm
062-210-18



CUSHING
24,0 cm, 9 1/2"



8 mm
062-212-08



10 mm
062-212-10



12 mm
062-212-12



14 mm
062-212-14



16 mm
062-212-16



18 mm
062-212-18

Wundhaken
Retractors
Separadores
Divaricatori



GIL-VERNET
24,0 cm, 9 1/2"



8 mm
062-220-08



11 mm
062-220-11



13 mm
062-220-13



17 mm
062-220-17



20 mm
062-220-20



23 mm
062-220-23



GIL-VERNET
24,0 cm, 9 1/2"



8 mm
062-230-08



11 mm
062-230-11



13 mm
062-230-13



17 mm
062-230-17



20 mm
062-230-20



23 mm
062-230-23

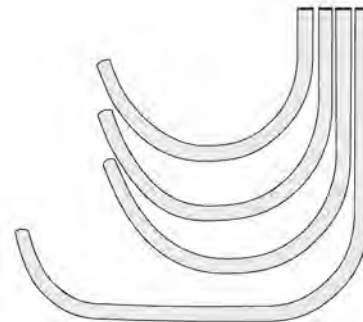
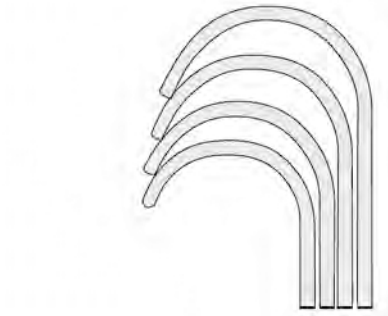


ROUX

- Fig. 1 24 x 20 mm
- Fig. 2 29 x 26 mm
- Fig. 3 33 x 29 mm
- Fig. 4 29 x 24 mm

Satz, Fig. 1-3
Set, fig. 1-3
Juego, fig. 1-3
Serie, fig. 1-3

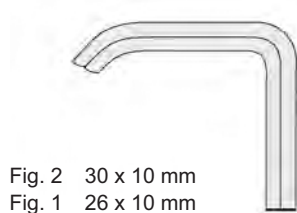
- Fig. 1 30 x 28 mm
- Fig. 2 36 x 36 mm
- Fig. 3 38 x 43 mm
- Fig. 4 45 x 28 mm



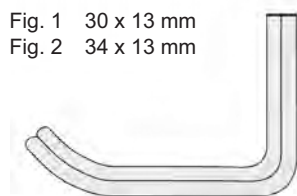
- | | | |
|----------|--|-------------------|
| Fig. 1-3 | 17,0 cm, 6 ³ / ₄ " | 062-310-00 |
| Fig. 1 | 14,0 cm, 5 ¹ / ₂ " | 062-310-01 |
| Fig. 2 | 15,0 cm, 6" | 062-310-02 |
| Fig. 3 | 17,0 cm, 6 ³ / ₄ " | 062-310-03 |
| Fig. 4 | 18,0 cm, 7" | 062-310-04 |



FARABEUF
12,0 cm, 4³/₄"
062-300-12



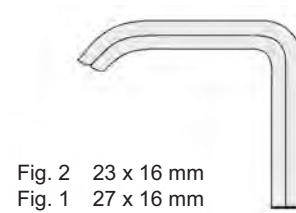
- Fig. 2 30 x 10 mm
- Fig. 1 26 x 10 mm



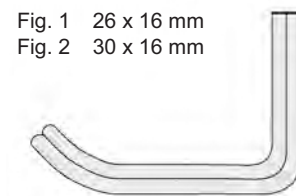
- Fig. 1 30 x 13 mm
- Fig. 2 34 x 13 mm



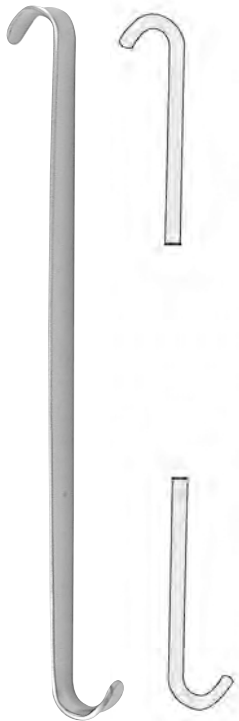
FARABEUF
15,0 cm, 5³/₄"
062-302-15



- Fig. 2 23 x 16 mm
- Fig. 1 27 x 16 mm



- Fig. 1 26 x 16 mm
- Fig. 2 30 x 16 mm



MINI-ROUX
14,0 cm, 5½"
062-340-06



BABY-ROUX
13,0 cm, 5"
062-342-13



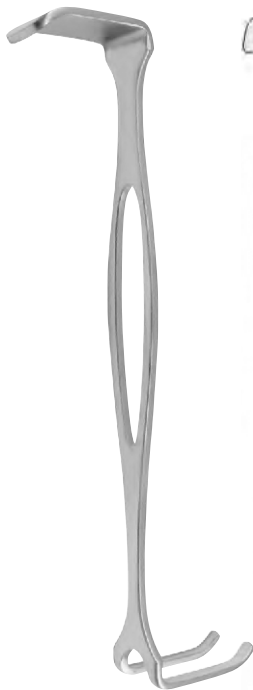
PARKER
13,5 cm, 5¾"
062-350-00

18 x 17 mm

24 x 21 mm

Fig. 2 22 x 15 mm
Fig. 1 19 x 15 mm

Fig. 1 19 x 15 mm
Fig. 2 22 x 15 mm



CZERNY
17,5 cm, 7"
062-360-00



36 mm



38 x 42 mm



MATHIEU
20,0 cm, 8"
062-380-00

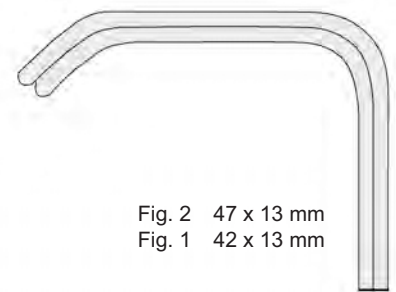


Fig. 2 47 x 13 mm
Fig. 1 42 x 13 mm

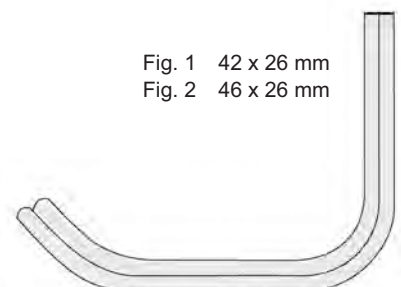
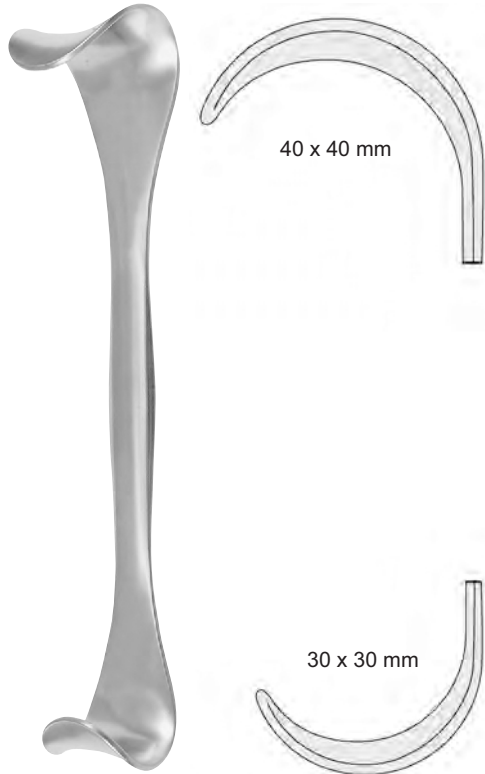
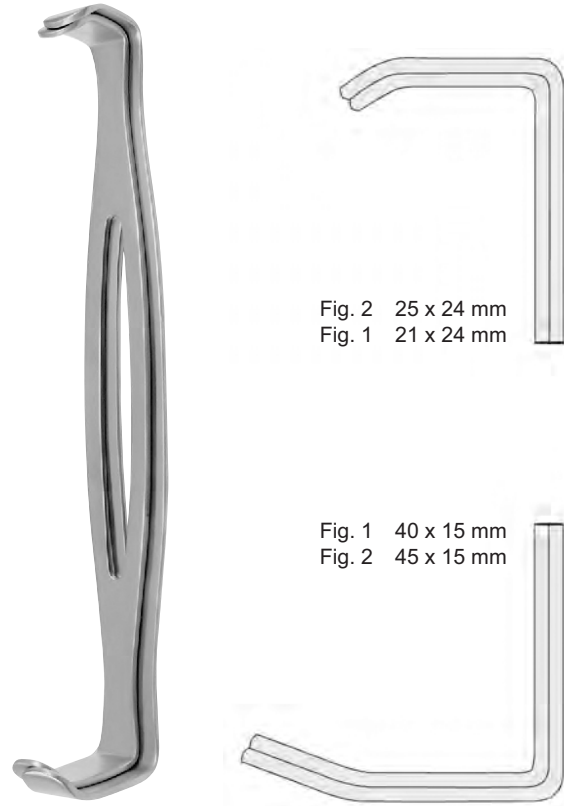


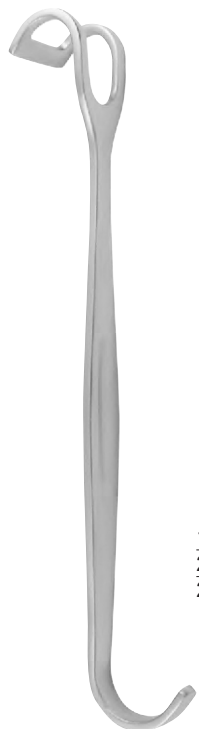
Fig. 1 42 x 26 mm
Fig. 2 46 x 26 mm



GOELET
19,0 cm, 7 1/2"
062-396-19



PARKER-LANGENBECK
21,0 cm, 8 1/4"
062-390-00



16 mm	19,0 cm, 7 1/2"	062-370-16
20 mm	19,0 cm, 7 1/2"	062-370-20
25 mm	20,0 cm, 8"	062-370-25

CANNY RYAL



VOLKMANN
21,5 cm, 8 1/2"



064-001-01



9 x 8 mm
064-001-02



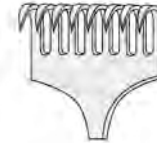
9 x 13 mm
064-001-03



9 x 19 mm
064-001-04



9 x 29 mm
064-001-06



9 x 40 mm
064-001-08

scharf
sharp
agudos
acuti



VOLKMANN
21,5 cm, 8 1/2"



064-003-01



9 x 8 mm
064-003-02



9 x 13 mm
064-003-03



9 x 19 mm
064-003-04



9 x 29 mm
064-003-06



9 x 40 mm
064-003-08

halbscharf
semi-sharp
semi-agudos
semi-acuti



VOLKMANN
21,5 cm, 8½"



064-002-01



9 x 8 mm
064-002-02



9 x 13 mm
064-002-03



9 x 19 mm
064-002-04



9 x 29 mm
064-002-06



9 x 40 mm
064-002-08

stumpf
blunt
romo
smusso



KOCHER
22,0 cm, 8⅝"



064-011-01



9 x 8 mm
064-011-02



15 x 15 mm
064-011-03



15 x 20 mm
064-011-04



15 x 30 mm
064-011-06



15 x 40 mm
064-011-08

scharf
sharp
agudos
acuti

Wundhaken
 Retractors
 Separadores
 Divaricatori



KOCHER
 22,0 cm, 8⁵/₈"



064-013-01



9 x 8 mm
064-013-02



15 x 15 mm
064-013-03



15 x 20 mm
064-013-04



15 x 30 mm
064-013-06



15 x 40 mm
064-013-08

halbscharf
 semi-sharp
 semi-agudos
 semi-acuti



KOCHER
 22,0 cm, 8⁵/₈"



064-012-01



9 x 8 mm
064-012-02



15 x 15 mm
064-012-03



15 x 20 mm
064-012-04

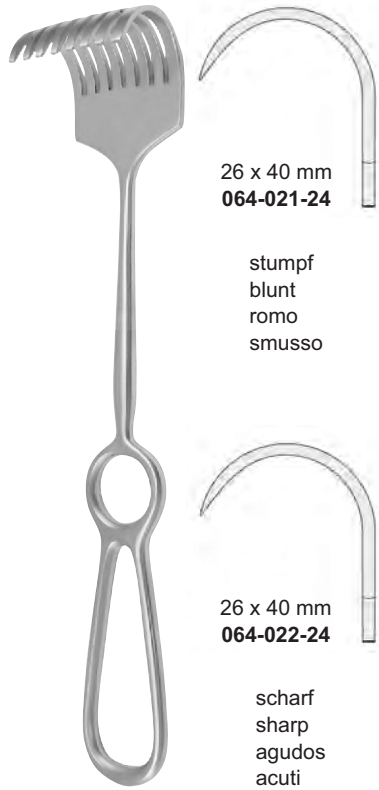


15 x 30 mm
064-012-06



15 x 40 mm
064-012-08

stumpf
 blunt
 romo
 smusso



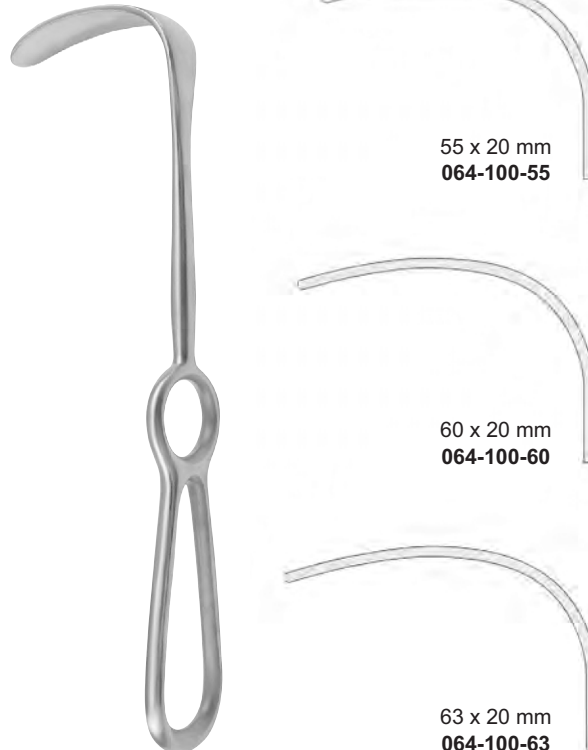
26 x 40 mm
064-021-24

stumpf
blunt
romo
smusso

26 x 40 mm
064-022-24

scharf
sharp
agudos
acuti

KOERTE
24,0 cm, 9½"



55 x 20 mm
064-100-55

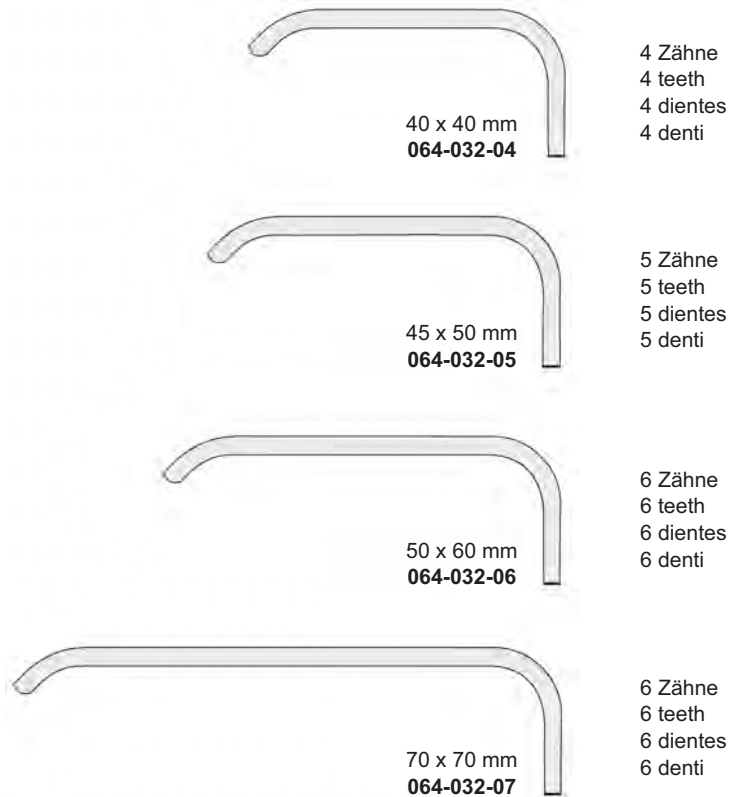
60 x 20 mm
064-100-60

63 x 20 mm
064-100-63

LANGENBECK
21,0 cm, 8¼"



ISRAEL
25,0 cm, 9¾"



40 x 40 mm
064-032-04

4 Zähne
4 teeth
4 dientes
4 denti

45 x 50 mm
064-032-05

5 Zähne
5 teeth
5 dientes
5 denti

50 x 60 mm
064-032-06

6 Zähne
6 teeth
6 dientes
6 denti

70 x 70 mm
064-032-07

6 Zähne
6 teeth
6 dientes
6 denti



LANGENBECK
22,0 cm, 8⁵/₈"



30 x 11 mm
064-110-30



30 x 14 mm
064-110-31



30 x 16 mm
064-110-32



40 x 11 mm
064-110-40



50 x 11 mm
064-110-50



LANGENBECK
22,0 cm, 8⁵/₈"



30 x 11 mm
064-120-30



30 x 14 mm
064-120-31



30 x 16 mm
064-120-32



40 x 11 mm
064-120-40



50 x 11 mm
064-120-50



KOCHER-LANGENBECK
21,5 cm, 8½"



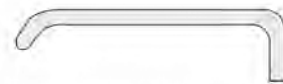
22 x 6 mm
064-130-22



25 x 6 mm
064-130-25



25 x 8 mm
064-130-26



35 x 8 mm
064-130-35



35 x 11 mm
064-130-36



35 x 15 mm
064-130-37



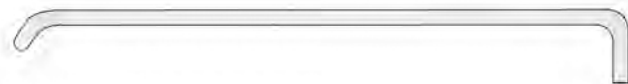
40 x 11 mm
064-130-40



70 x 14 mm
064-130-70



80 x 12 mm
064-130-80



80 x 16 mm
064-130-85

Wundhaken
Retractors
Separadores
Divaricatori



KOCHER
23,0 cm, 9"



40 x 18 mm
064-140-18



60 x 20 mm
064-140-20



60 x 25 mm
064-140-25



75 x 30 mm
064-140-30



75 x 40 mm
064-140-40



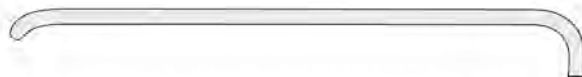
SAUERBRUCH
22,5 cm, 8³/₄"



44 x 16 mm
064-150-44



55 x 22 mm
064-150-55



72 x 19 mm
064-150-72



MIDDELDORPF



21,5 cm, 8½"
14 x 17 mm
064-180-01



22,0 cm, 8⅝"
20 x 22 mm
064-180-02



23,5 cm, 9¼"
26 x 30 mm
064-180-03



MIDDELDORPF



21,5 cm, 8½"
14 x 17 mm
064-182-01



22,0 cm, 8⅝"
20 x 22 mm
064-182-02



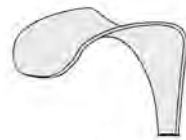
23,5 cm, 9¼"
26 x 30 mm
064-182-03



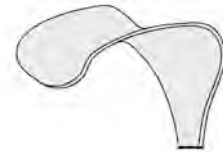
RICHARDSON (KELLY)
24,0 cm, 9½"



28 x 20 mm
064-210-02



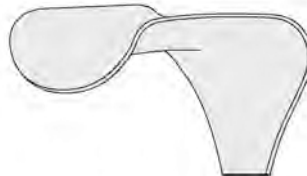
36 x 28 mm
064-210-03



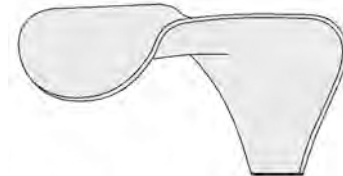
44 x 38 mm
064-210-04



52 x 22 mm
064-210-05



65 x 50 mm
064-210-06



70 x 65 mm
064-210-07

**Wundhaken
Retractors
Separadores
Divaricatori**



49 x 38 mm

28 x 20 mm

Fig. 2

Fig. 1

Fig. 1+2	28,0 cm, 11"	062-200-00
Fig. 1	26,0 cm, 10 ¹ / ₄ "	062-200-01
Fig. 2	28,0 cm, 11"	062-200-02

36 x 28 mm

63 x 49 mm

RICHARDSON-EASTMAN

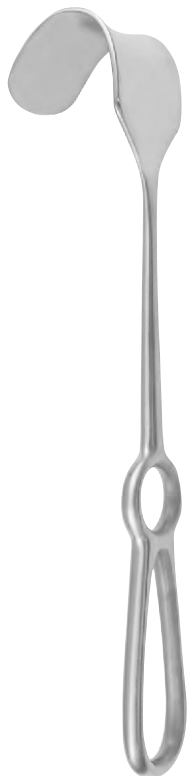


MIDDELDORPF

25,5 cm, 10"



40 x 45 mm	064-192-01
45 x 50 mm	064-192-02
55 x 70 mm	064-192-03



FRITSCH
24,0 cm, 9¹/₂"

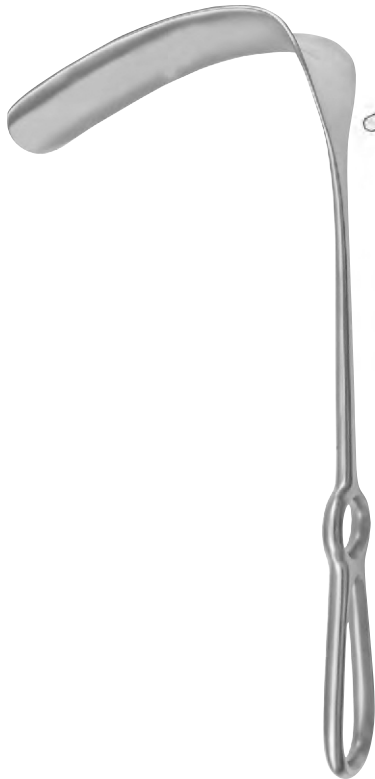


45 x 40 mm	064-240-40
45 x 50 mm	064-240-50
45 x 60 mm	064-240-60
55 x 75 mm	064-240-75
65 x 85 mm	064-240-85

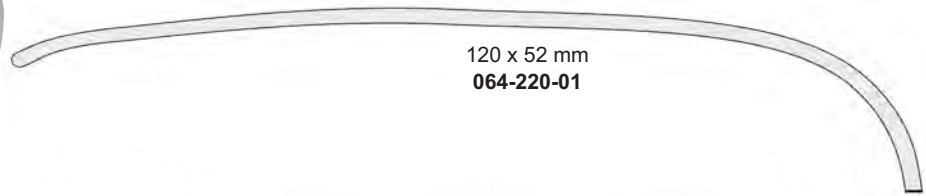


50 x 85 mm

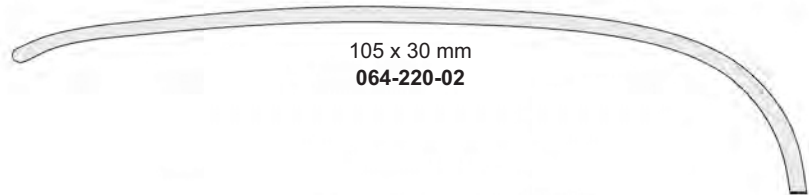
DOYEN
25,0 cm, 10"
064-230-50



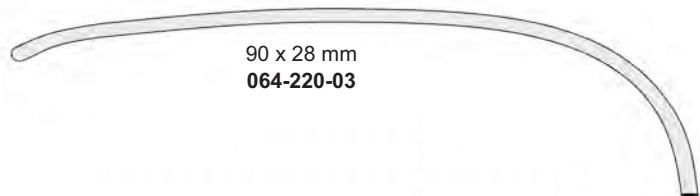
DOYEN-STILLE
22,0 cm, 8⁵/₈"



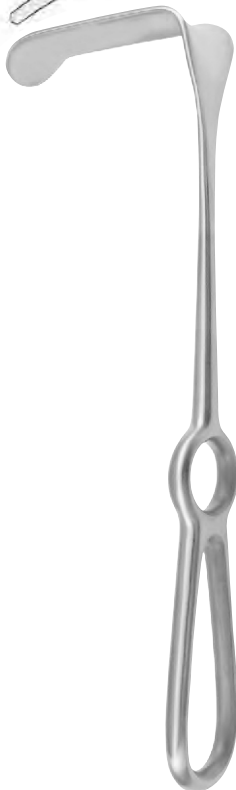
120 x 52 mm
064-220-01



105 x 30 mm
064-220-02

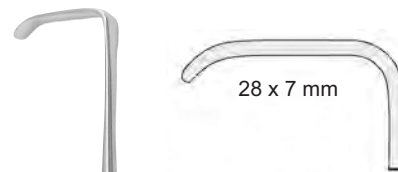


90 x 28 mm
064-220-03



KOCHER
25,0 cm, 10"

70 x 25 mm	064-250-70
80 x 42 mm	064-250-81
80 x 50 mm	064-250-82
80 x 60 mm	064-250-83



28 x 7 mm



LAHEY
19,0 cm, 7¹/₂"
061-160-19



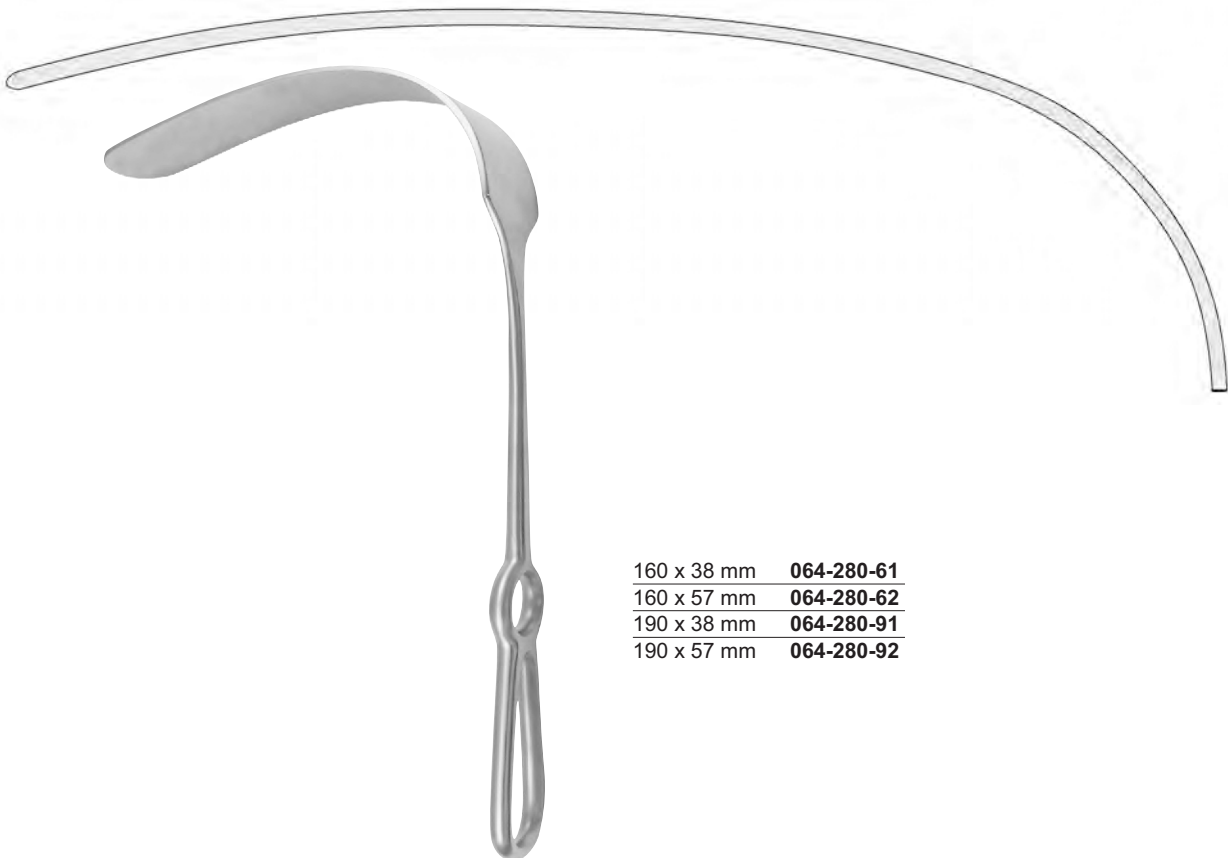
LITTLE
 20,0 cm, 8"
 064-164-20



12 x 13 mm



SIMON
 28,0 cm, 11"
 115 x 22 mm **064-260-01**
 115 x 27 mm **064-260-02**



KELLY
 27,0 cm, 10 1/2"

- 160 x 38 mm **064-280-61**
- 160 x 57 mm **064-280-62**
- 190 x 38 mm **064-280-91**
- 190 x 57 mm **064-280-92**



85 x 35 mm	064-274-01
120 x 50 mm	064-274-02
150 x 50 mm	064-274-03

MIKULICZ
26,0 cm, 10¹/₄"



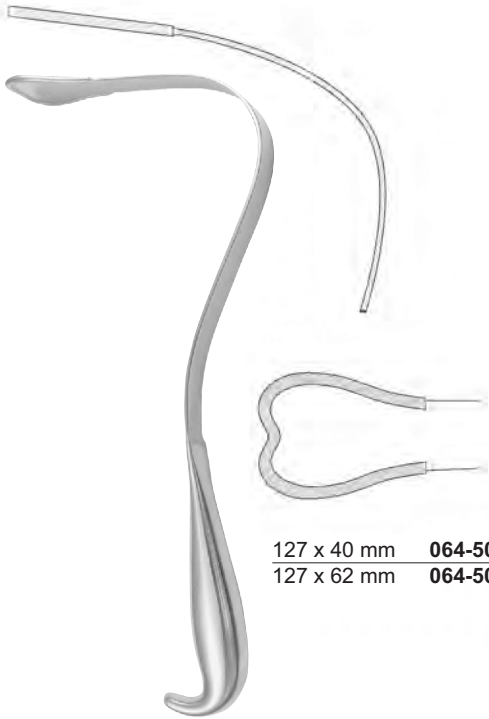
90 x 50 mm

MIKULICZ
26,0 cm, 10¹/₄"
064-272-90



70 x 38 mm	064-290-38
70 x 50 mm	064-290-51

MORRIS
24,5 cm, 9⁵/₈"



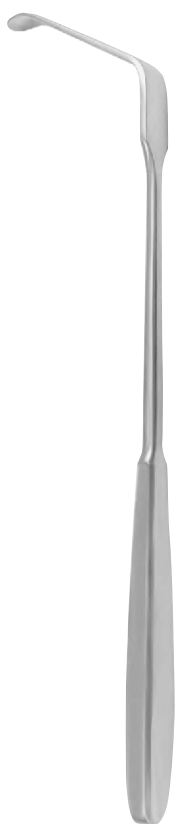
127 x 40 mm **064-500-40**
 127 x 62 mm **064-500-62**

HARRINGTON
 32,0 cm, 12½"

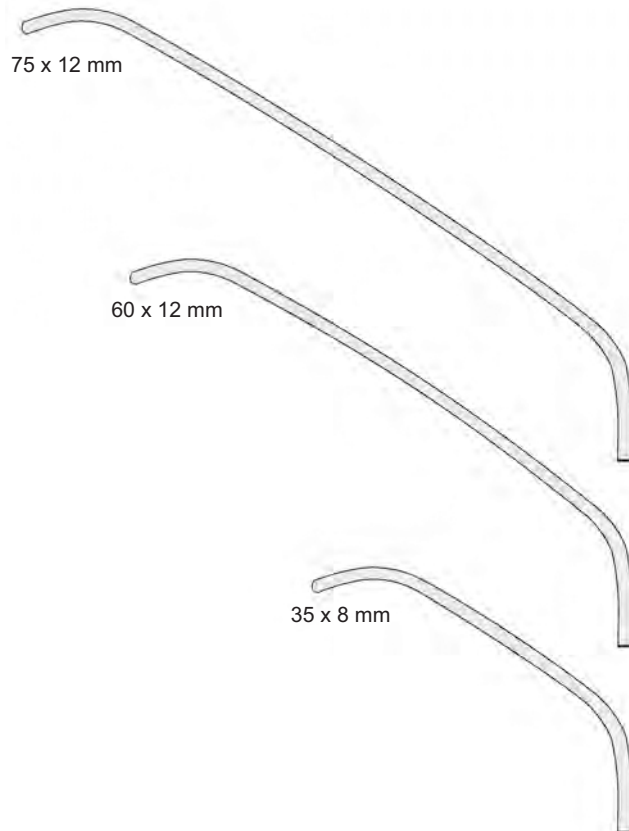


82 x 22 mm **064-390-01**
 108 x 43 mm **064-390-02**
 115 x 65 mm **064-390-03**

CORYKKOS
 24,0 cm, 9½"



ZENKER



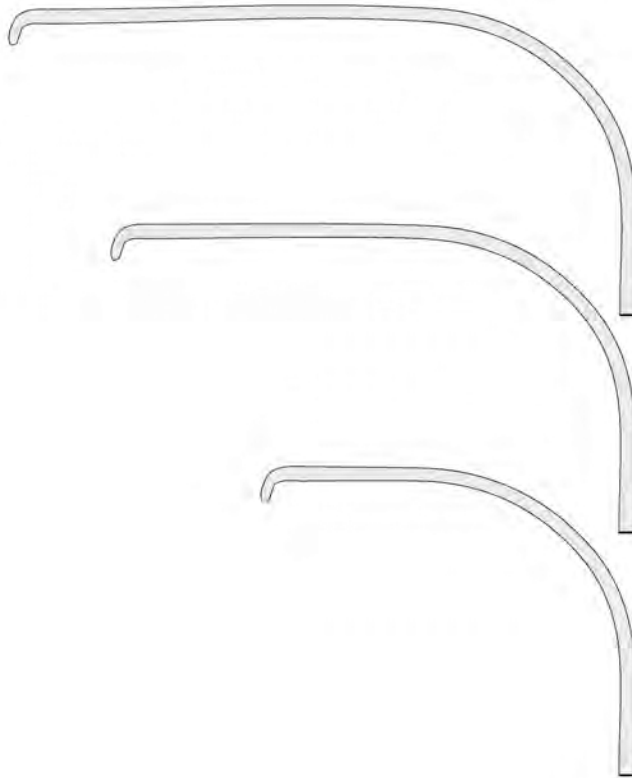
25,0 cm, 9¾"
064-320-25

26,0 cm, 10¼"
064-320-26

27,5 cm, 10¾"
064-320-27



MEYERDING
22,5 cm, 8³/₄"



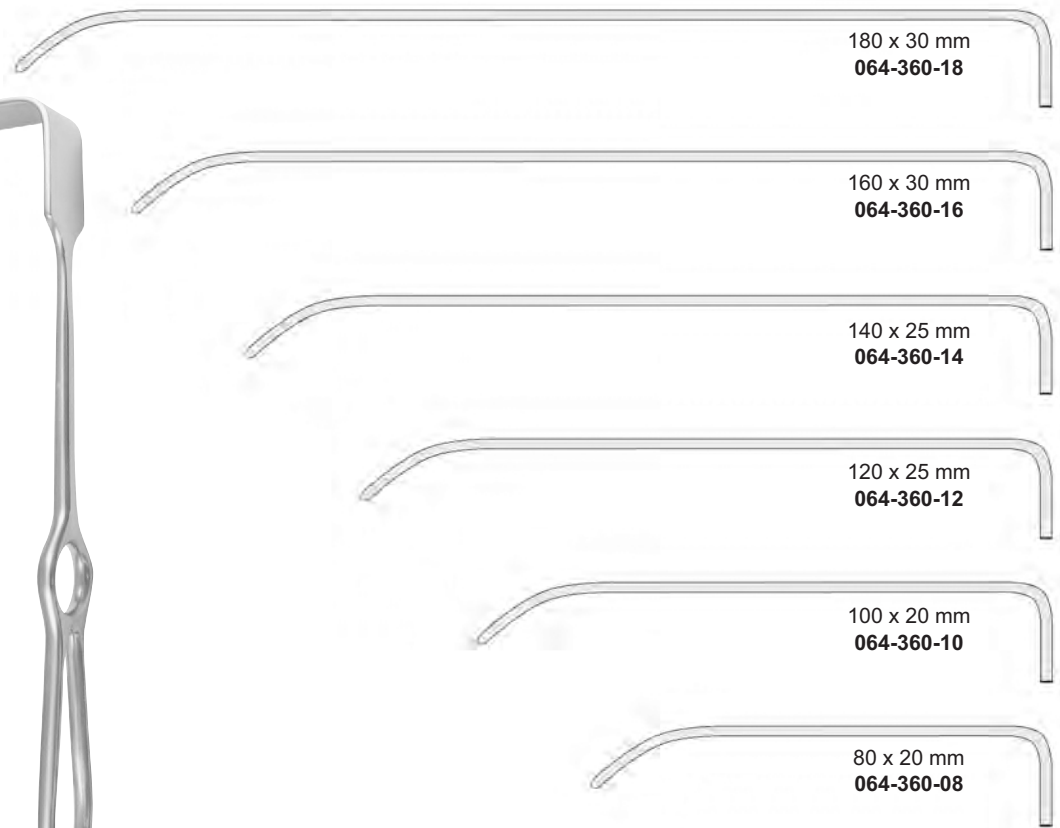
90 x 50 mm
064-350-50

75 x 25 mm
064-350-25

50 x 16 mm
064-350-16



BRUNNER
25,0 cm, 10"



180 x 30 mm
064-360-18

160 x 30 mm
064-360-16

140 x 25 mm
064-360-14

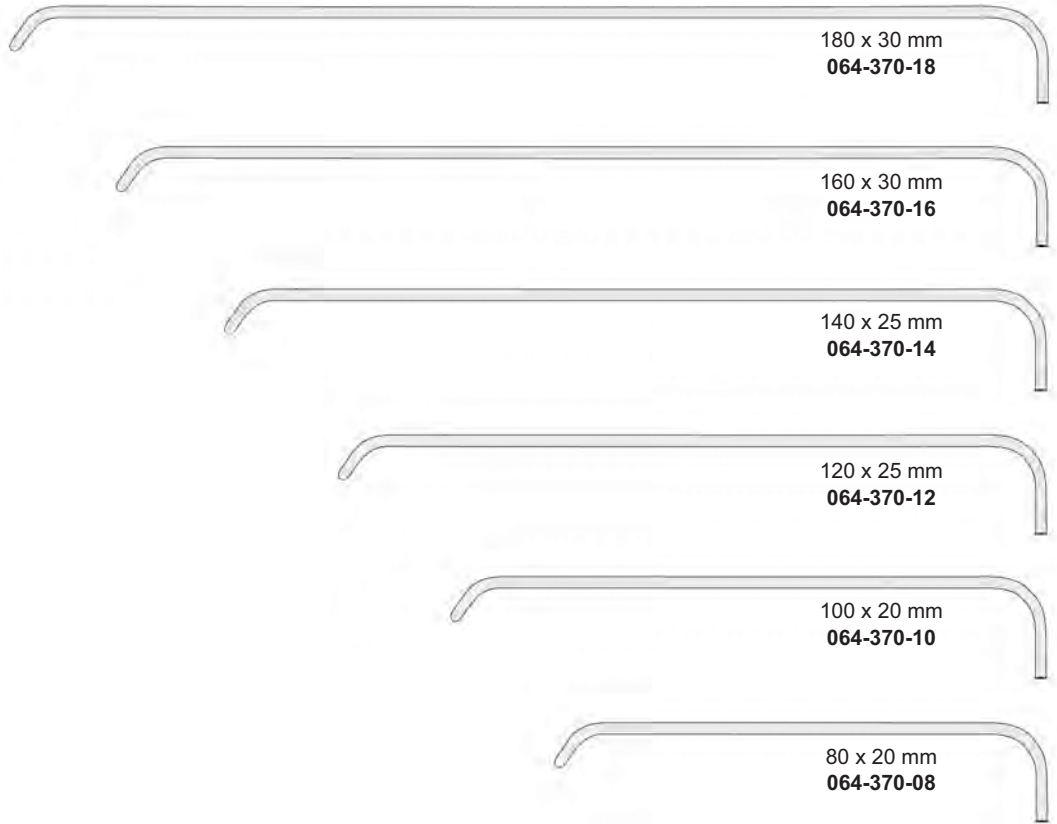
120 x 25 mm
064-360-12

100 x 20 mm
064-360-10

80 x 20 mm
064-360-08



BRUNNER
 25,0 cm, 10"



180 x 30 mm
064-370-18

160 x 30 mm
064-370-16

140 x 25 mm
064-370-14

120 x 25 mm
064-370-12

100 x 20 mm
064-370-10

80 x 20 mm
064-370-08



19 mm

DEAVER
 18,0 cm, 7"
064-602-18



22 mm

DEAVER
 21,5 cm, 8½"
064-602-22



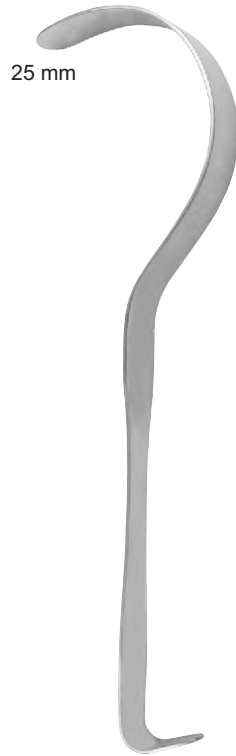
25 mm

DEAVER
 23,0 cm, 9"
064-602-23



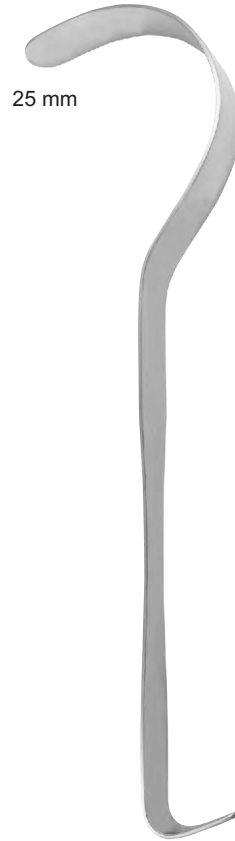
25 mm

DEAVER
30,0 cm, 11³/₄"
064-604-30



25 mm

DEAVER
33,0 cm, 13"
064-604-33



25 mm

DEAVER
36,0 cm, 14¹/₈"
064-604-36



38 mm

DEAVER
30,0 cm, 11³/₄"
064-610-38



50 mm

DEAVER
30,0 cm, 11³/₄"
064-610-50



75 mm

DEAVER
30,0 cm, 11³/₄"
064-610-75



25 mm	064-600-25
38 mm	064-600-38
50 mm	064-600-50
75 mm	064-600-75

DEAVER
30,0 cm, 11³/₄"



40 mm	30,0 cm, 11 ³ / ₄ "	064-700-30
54 mm	32,0 cm, 12 ¹ / ₂ "	064-700-32

ALLISON

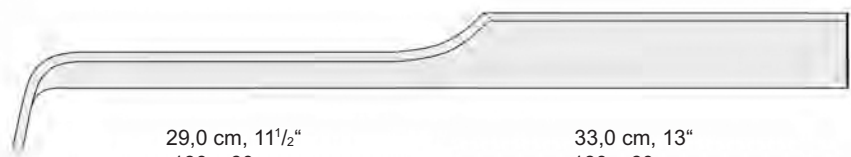


75 x 50 mm	16,0 cm, 6 ¹ / ₄ "	064-710-50
75 x 90 mm	16,0 cm, 6 ¹ / ₄ "	064-710-90

DAVIDSON



ST MARKS



29,0 cm, 11¹/₂"
130 x 60 mm
064-720-01

33,0 cm, 13"
180 x 60 mm
064-720-02



29,0 cm, 11¹/₂"
130 x 60 mm
064-721-01

33,0 cm, 13"
180 x 60 mm
064-721-02

	5,0 cm, 2" 070-610-05	5,0 cm, 2" 070-611-05
	7,0 cm, 2 ³ / ₄ " 070-610-07	7,0 cm, 2 ³ / ₄ " 070-611-07
	scharf sharp agudos acuti	stumpf blunt romo smusso
FINSEN		

JANSEN
10,0 cm, 4"

070-630-10	070-631-10
scharf sharp agudos acuti	stumpf blunt romo smusso

	scharf	halbscharf	stumpf
	sharp	semi-sharp	blunt
	agudos	semi-agudos	romo
	acuti	semi-acuti	smusso
	7,0 cm, 2 ³ / ₄ "	070-620-07	070-622-07
	10,0 cm, 4"	070-620-10	070-621-10
ALM			

ALLPORT
9,5 cm, 3³/₄"
070-626-09



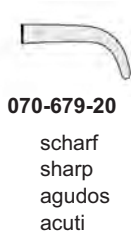
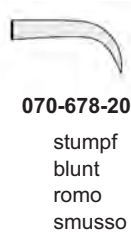
SALP-CONTOUR
14,0 cm, 5 1/2"



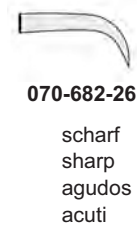
ADSON-BABY
16,0 cm, 6 1/4"

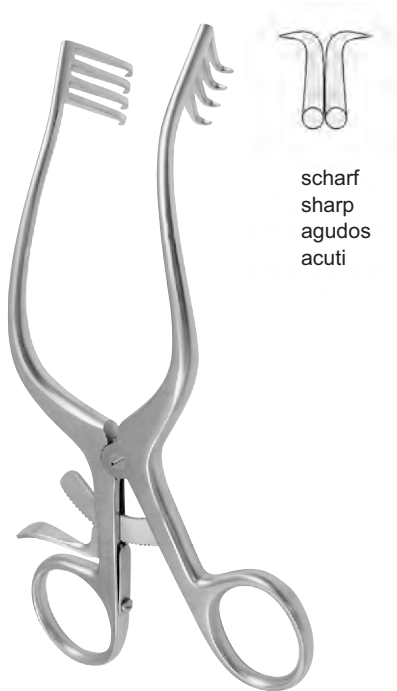


ANDERSON-ADSON
19,0 cm, 8"



ADSON
26,5 cm, 10 1/2"





scharf
 sharp
 agudos
 acuti

MOLLISON
 15,5 cm, 6"
 070-674-15



070-800-12

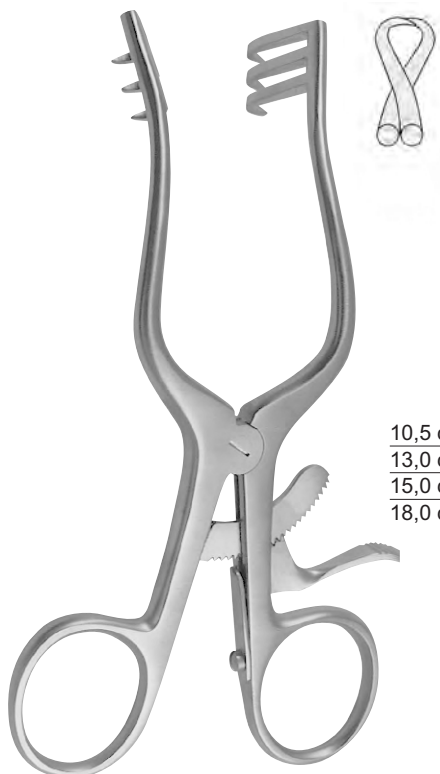
scharf
 sharp
 agudos
 acuti



070-801-12

stumpf
 blunt
 romo
 smuss

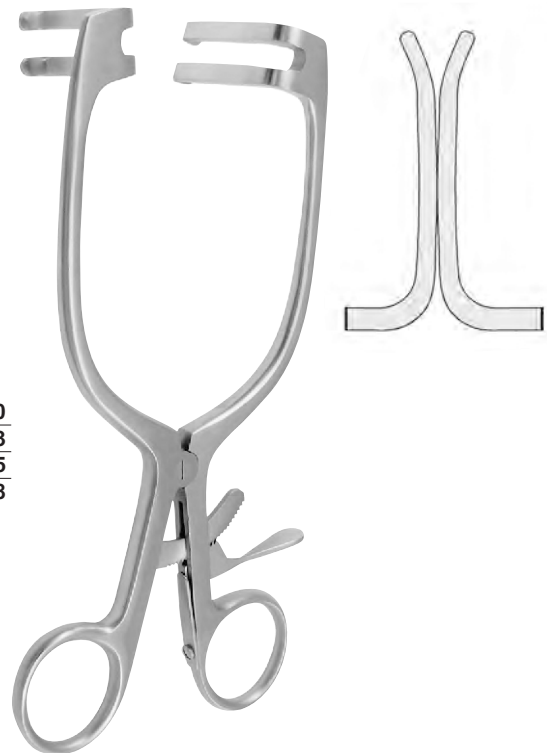
SCHUHKNECHT
 12,5 cm, 5"



scharf stumpf
 sharp blunt
 agudos romo
 acuti smusso

10,5 cm, 4 1/8"	070-810-10	070-811-10
13,0 cm, 5"	070-810-13	070-811-13
15,0 cm, 6"	070-810-15	070-811-15
18,0 cm, 7"	070-810-18	070-811-18

WULLSTEIN



MAYO-ADAMS
 16,5 cm, 6 1/2"
 070-822-17



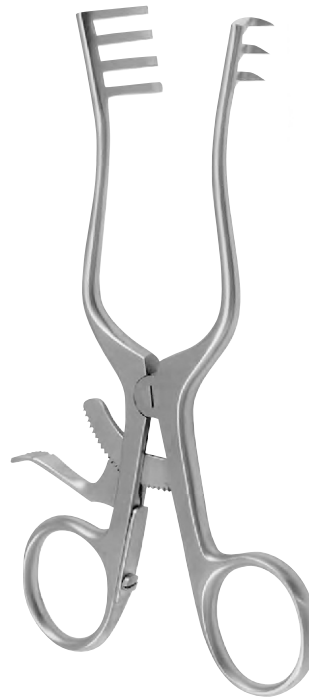
WEITLANER-LOKTITE
10,5 cm, 4 1/8"



070-650-10
scharf
sharp
agudos
acuti



070-651-10
stumpf
blunt
romo
smusso



WEITLANER
13,0 cm, 5"



070-670-13
scharf
sharp
agudos
acuti



070-671-13
stumpf
blunt
romo
smusso



WEITLANER
16,5 cm, 6 1/2"



070-670-16
scharf
sharp
agudos
acuti



070-671-16
stumpf
blunt
romo
smusso



WEITLANER
20,0 cm, 8"



070-670-20
scharf
sharp
agudos
acuti



070-671-20
stumpf
blunt
romo
smusso

Wundspreizer
 Self-Retaining Retractors
 Separadores con retenida automática
 Divaricatori autostatici



WEITLANER
 24,0 cm, 9½"



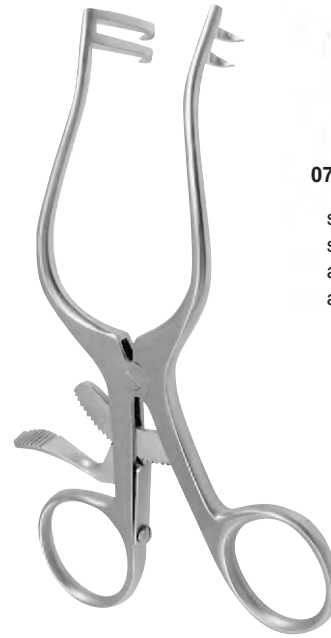
070-670-24

scharf
 sharp
 agudos
 acuti



070-671-24

stumpf
 blunt
 romo
 smusso



PLESTER
 13,0 cm, 5"



070-830-13

scharf
 sharp
 agudos
 acuti



070-831-13

stumpf
 blunt
 romo
 smusso



MILLIGAN
 13,0 cm, 5"
070-840-13



PLESTER
 11,0 cm, 4¾"
070-672-11



PLESTER
 11,0 cm, 4¾"
070-673-11

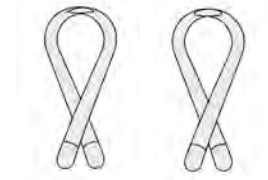




WEITLANER-BABY
13,0 cm, 5"
070-850-13

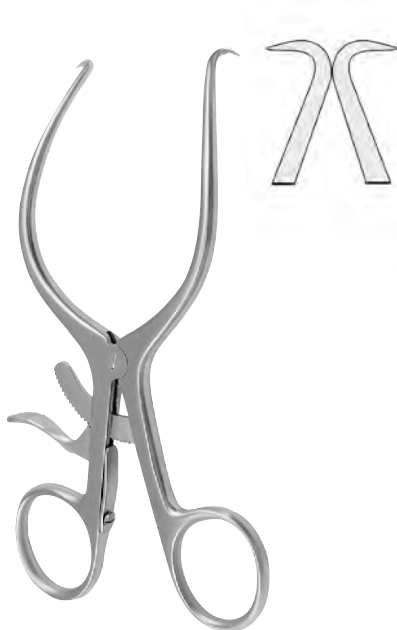


ADSON
(CONE)



20,0 cm, 8" **070-860-20** **070-861-20**
26,0 cm, 10 1/4" **070-860-26** **070-861-26**

scharf stumpf
sharp blunt
agudos romo
acuti smusso



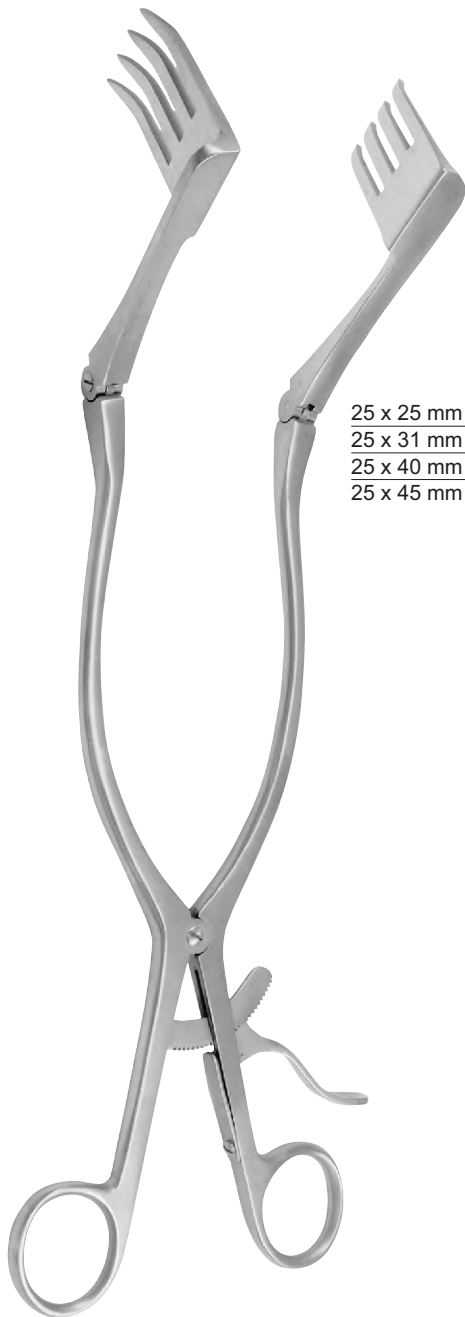
GELPI
13,5 cm, 5 3/8"
070-202-14



GELPI
19,0 cm, 7 1/2"
070-202-19



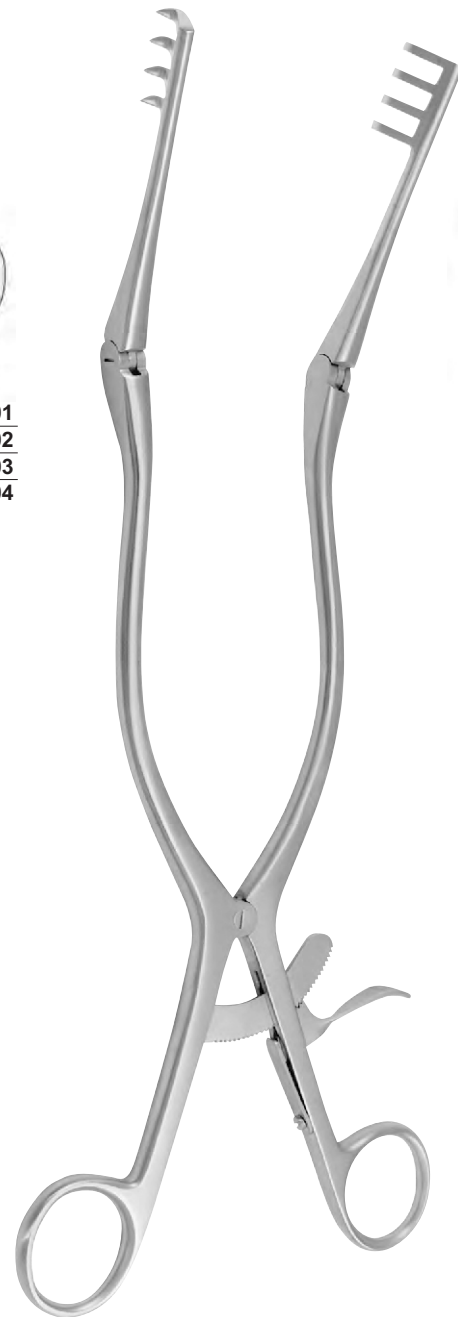
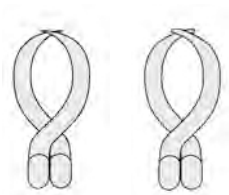
GELPI-LOKTITE
18,0 cm, 7 1/2"
070-250-19



BECKMANN-ADSON
 31,0 cm, 12 1/4"

25 x 25 mm	070-870-01	070-871-01
25 x 31 mm	070-870-02	070-871-02
25 x 40 mm	070-870-03	070-871-03
25 x 45 mm	070-870-04	070-871-04

scharf	stumpf
sharp	blunt
agudos	romo
acuti	smusso



BECKMANN
 31,0 cm, 12 1/4"



070-690-31
 scharf
 sharp
 agudos
 acuti



BECKMANN
32,0 cm, 12½"



070-691-32

stumpf
blunt
romo
smusso

070-690-31



DE BAKEY

10,0 cm, 4" **070-240-10**
14,0 cm, 5½" **070-240-14**

Wundspreizer
 Self-Retaining Retractors
 Separadores con retenida automática
 Divaricatori autostatici



stumpf
 blunt
 romo
 smusso

NORFOLK AND NORWICH
 22,0 cm, 8⁵/₈"
 070-401-22



stumpf
 blunt
 romo
 smusso

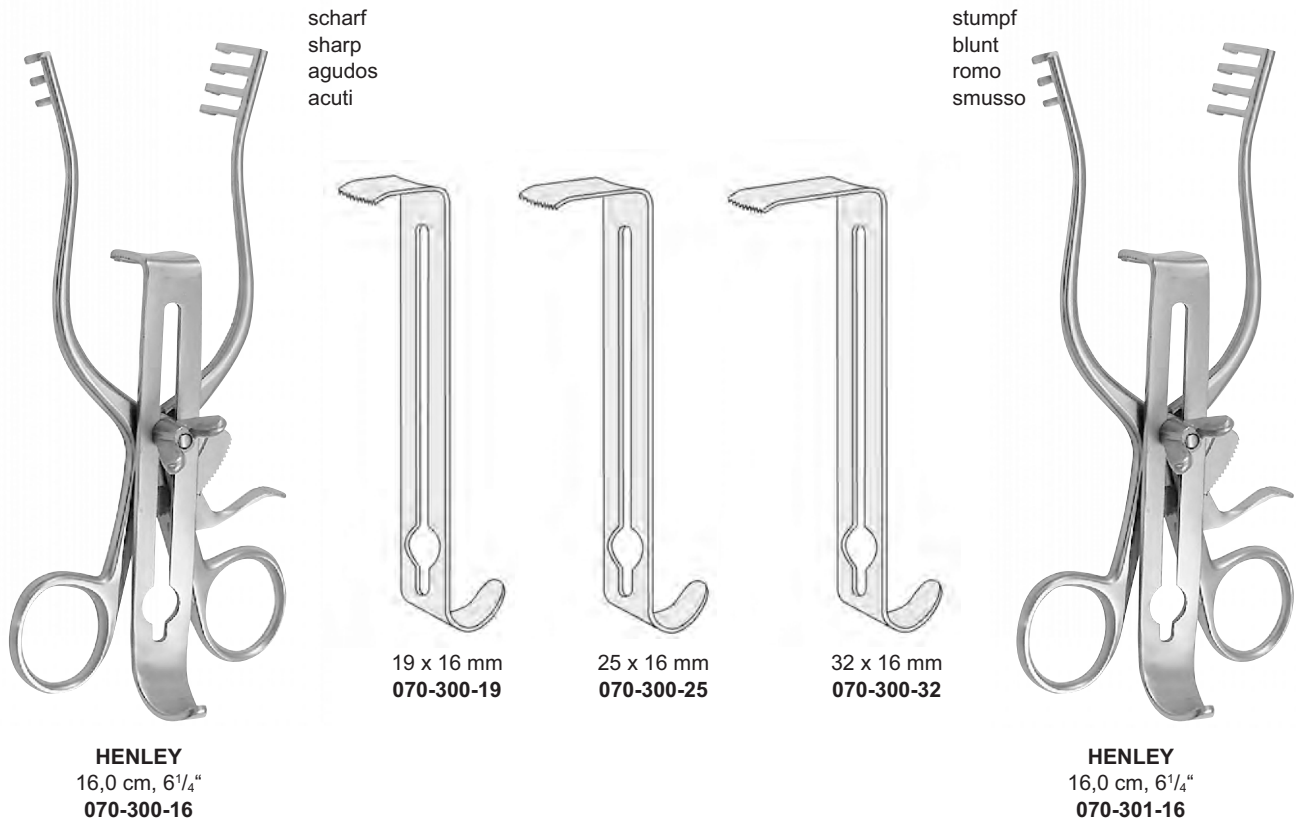
JACKSON BURROWS
 17,5 cm, 7"
 070-411-17



RICHTER
 17,0 cm, 6³/₄"
 070-420-17



JOLL (FRIEDMAN)
 15,5 cm, 6"
 070-430-15



HENLEY
070-300-00

komplett, bestehend aus:

- 1 Sperrer mit Seitenventilen, scharf (30-1300-16)
- 1 Mittelvalve 19 x 16 mm (30-1300-19)
- 1 Mittelvalve 25 x 16 mm (30-1300-25)
- 1 Mittelvalve 32 x 16 mm (30-1300-32)

complete, consisting of:

- 1 Spreader with lateral valves, sharp (30-1300-16)
- 1 Central valve 19 x 16 mm (30-1300-19)
- 1 Central valve 25 x 16 mm (30-1300-25)
- 1 Central valve 32 x 16 mm (30-1300-32)

completo, compuesto of:

- 1 Separador con valvas laterales, agudas (30-1300-16)
- 1 Valva central 19 x 16 mm (30-1300-19)
- 1 Valva central 25 x 16 mm (30-1300-25)
- 1 Valva central 32 x 16 mm (30-1300-32)

completo, composto da:

- 1 Divaricatore con valve laterali, acuto (30-1300-16)
- 1 Valva centrale 19 x 16 mm (30-1300-19)
- 1 Valva centrale 25 x 16 mm (30-1300-25)
- 1 Valva centrale 32 x 16 mm (30-1300-32)

HENLEY
070-301-00

komplett, bestehend aus:

- 1 Sperrer mit Seitenventilen, stumpf (30-1301-16)
- 1 Mittelvalve 19 x 16 mm (30-1300-19)
- 1 Mittelvalve 25 x 16 mm (30-1300-25)
- 1 Mittelvalve 32 x 16 mm (30-1300-32)

complete, consisting of:

- 1 Spreader with lateral valves, blunt (30-1301-16)
- 1 Central valve 19 x 16 mm (30-1300-19)
- 1 Central valve 25 x 16 mm (30-1300-25)
- 1 Central valve 32 x 16 mm (30-1300-32)

completo, compuesto of:

- 1 Separador con valvas laterales, romas (30-1301-16)
- 1 Valva central 19 x 16 mm (30-1300-19)
- 1 Valva central 25 x 16 mm (30-1300-25)
- 1 Valva central 32 x 16 mm (30-1300-32)

completo, composto da:

- 1 Divaricatore con valve laterali, smusso (30-1301-16)
- 1 Valva centrale 19 x 16 mm (30-1300-19)
- 1 Valva centrale 25 x 16 mm (30-1300-25)
- 1 Valva centrale 32 x 16 mm (30-1300-32)

Wundspreizer, Bauchdeckenhalter
 Self-Retaining Retractors, Abdominal Retractors
 Separadores con retenida automática, Separadores abdominales
 Divaricatori autostatici, Divaricatori addominali



MAYO-ADAMS
 17,0 cm, 6³/₄"
 070-320-17



COLLIN-BABY
 18,0 cm, 7"
 070-330-18

30 x 44 mm
 070-330-30

Wechselvalven
 Exchangeable blades
 Valvas intergambiabili
 Valve intercambiabili



23 x 44 mm
 070-330-23



RICARD
 28,0 cm, 11"
 074-310-28



RICARD
 30,0 cm, 12"
 074-312-30

38 x 62 mm
074-398-10

← 135-160 mm →



COLLIN
23,5 cm, 9 1/4"
074-330-24

40 x 80 mm

← 135-160 mm →



COLLIN
23,5 cm, 9 1/4"
074-332-24

60 x 80 mm
074-398-13

← 135-160 mm →



COLLIN
23,5 cm, 9 1/4"
074-334-24

Wundspreizer, Bauchdeckenhalter
 Self-Retaining Retractors, Abdominal Retractors
 Separadores con retenida automática, Separadores abdominales
 Divaricatori autostatici, Divaricatori addominali



38 x 62 mm **074-399-01**
 40 x 80 mm **074-399-02**
 60 x 80 mm **074-399-03**



50 x 58 mm **074-399-10**
 60 x 80 mm **074-399-13**
 72 x 85 mm **074-399-14**



074-399-23
 60 x 80 mm



074-399-33
 60 x 80 mm



58 x 50 mm **074-398-01**
 80 x 60 mm **074-398-02**
 85 x 72 mm **074-398-03**



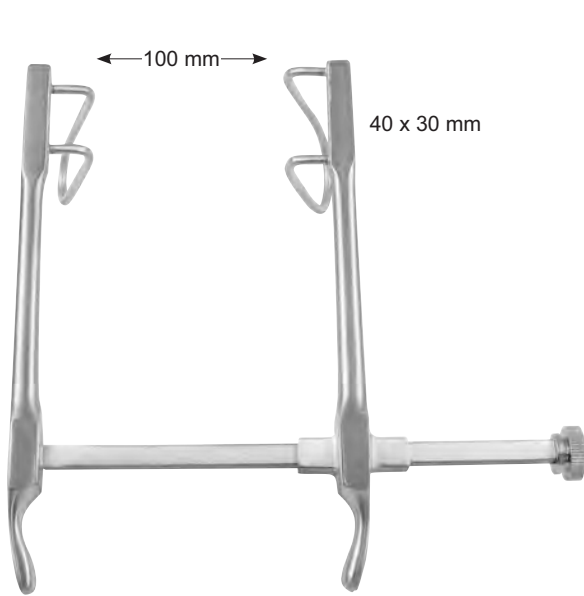
62 x 38 mm **074-398-10**
 80 x 38 mm **074-398-11**
 100 x 38 mm **074-398-12**
 80 x 38 mm **074-398-13**



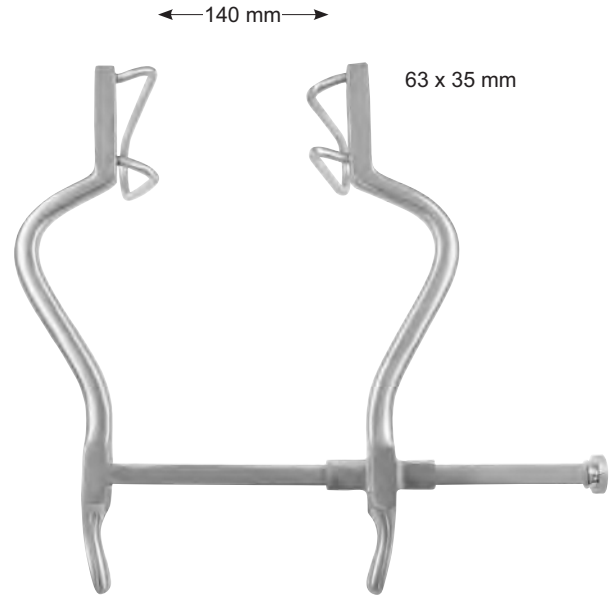
COLLIN
 55 x 55 mm **074-331-01**
 55 x 65 mm **074-331-02**
 55 x 75 mm **074-331-03**



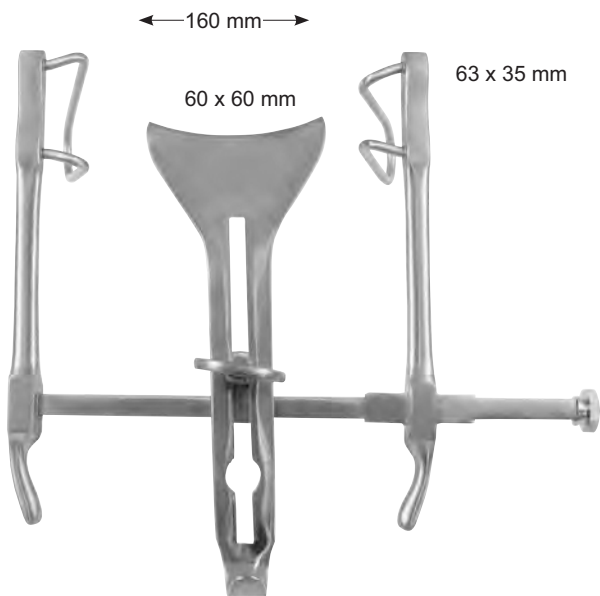
RICARD
 65 x 50 mm **074-310-01**
 70 x 55 mm **074-310-02**
 90 x 80 mm **074-310-03**



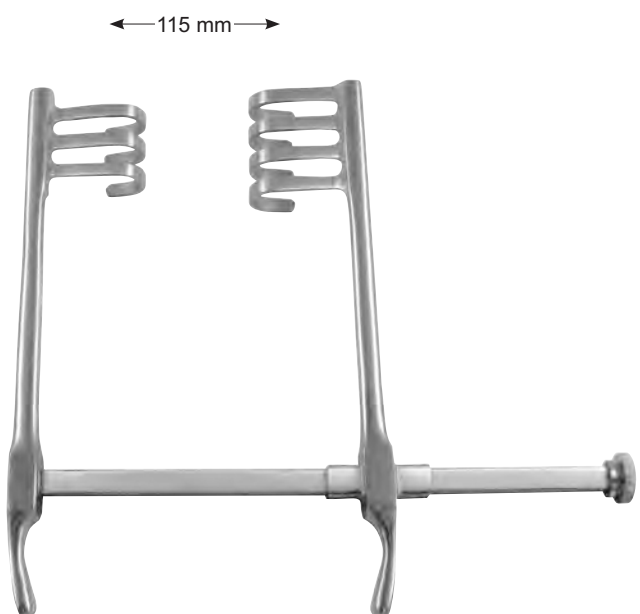
GOSSET
074-400-10



GOSSET
074-412-14



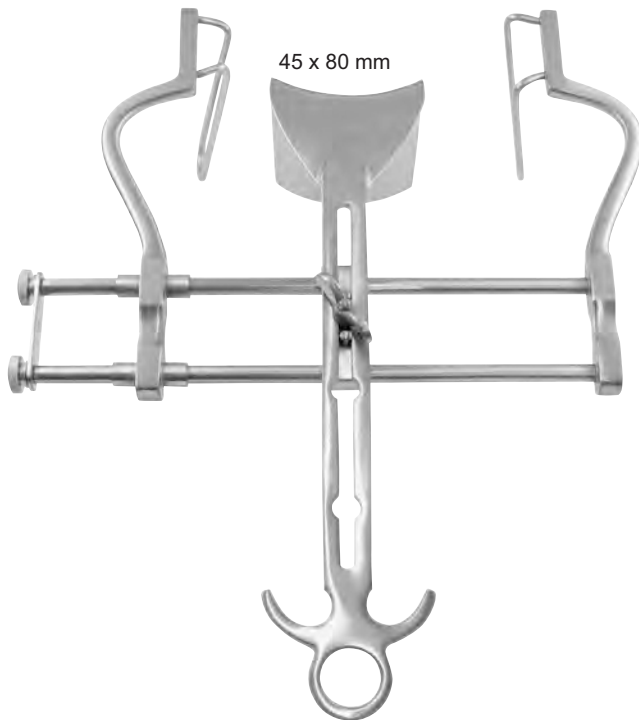
GOSSET
074-414-16



ABADIE
074-450-12

63 x 35 mm

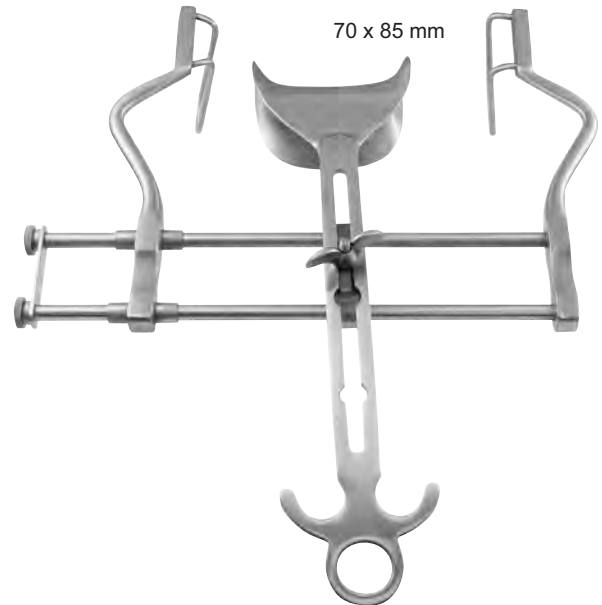
← 180 mm →



BALFOUR
074-764-18

100 x 35 mm

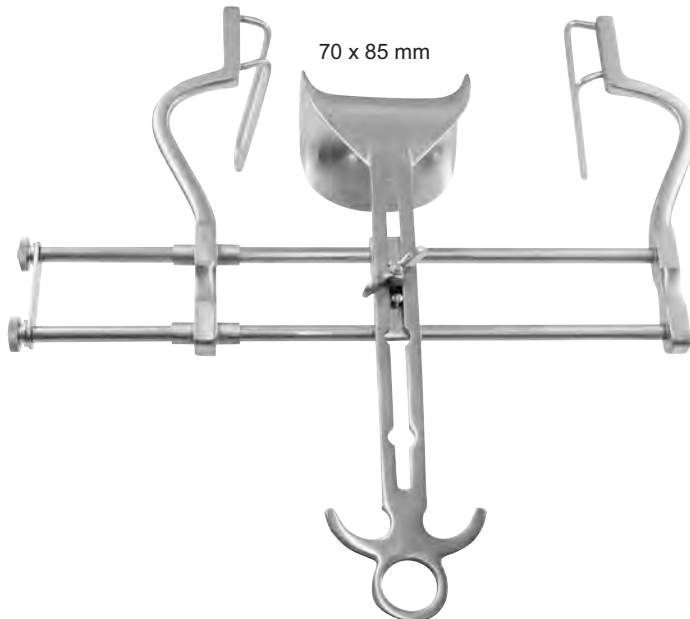
← 200 mm →



BALFOUR
074-768-20

100 x 35 mm

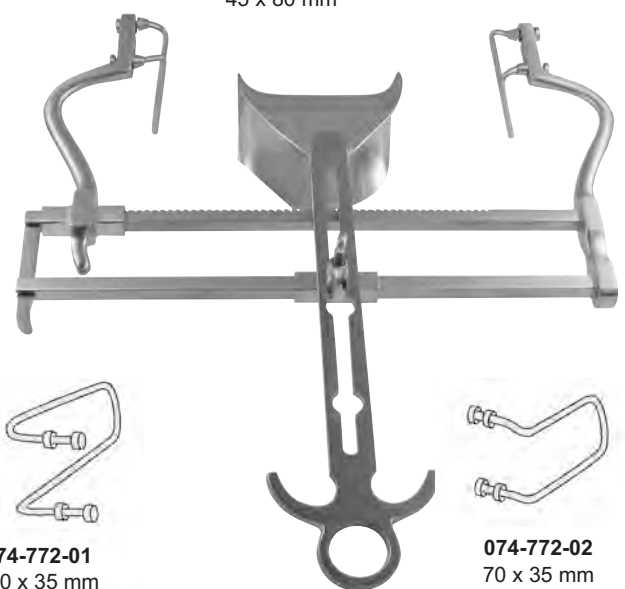
← 250 mm →



BALFOUR
074-768-25

← 250 mm →

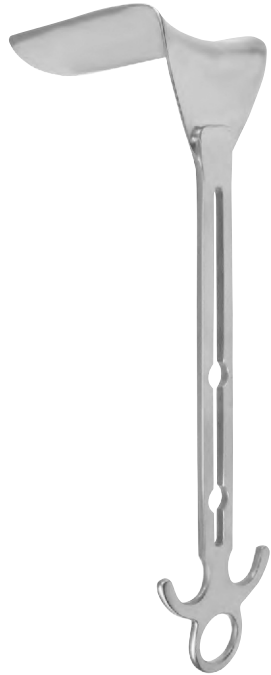
45 x 80 mm



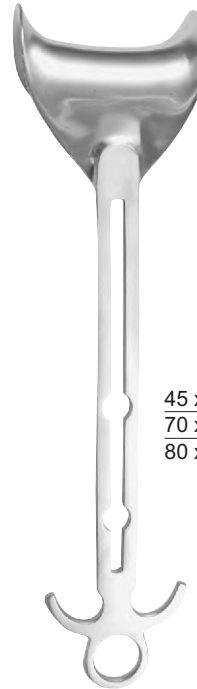
074-772-01
 100 x 35 mm

074-772-02
 70 x 35 mm

BALFOUR US-TYPE
074-772-25

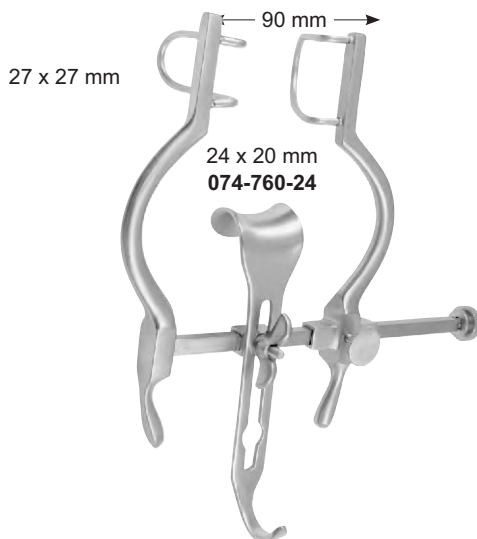


BALFOUR
100 x 70 mm
074-799-70

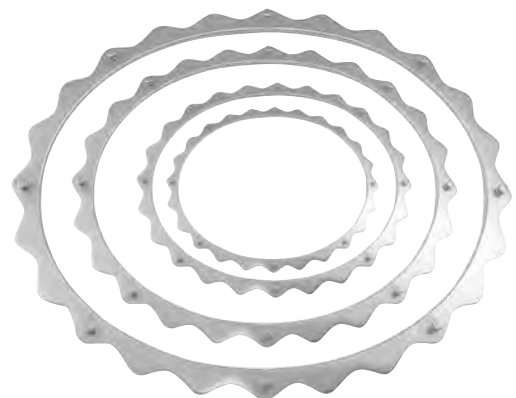


45 x 80 mm	074-798-01
70 x 85 mm	074-798-02
80 x 90 mm	074-798-03

BALFOUR



BALFOUR
074-760-09



Ø 180 mm, 7"	074-850-18
Ø 230 mm, 9"	074-850-23
Ø 305 mm, 12"	074-850-30
455 x 330 mm	074-850-45

geschwärzt, black finish, negra, nera;



074-859-02
51 x 38 mm



074-859-03
70 x 60 mm



074-859-05
114 x 60 mm

geschwärzt, black finish, negra, nera



074-859-06
19 x 76 mm



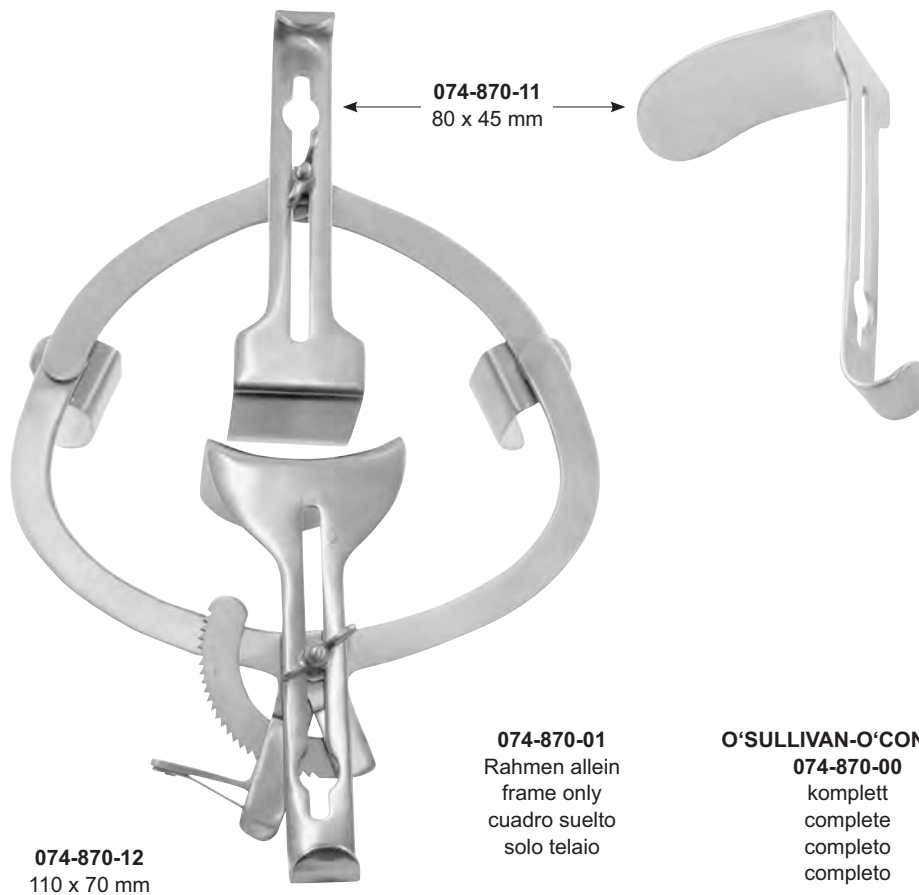
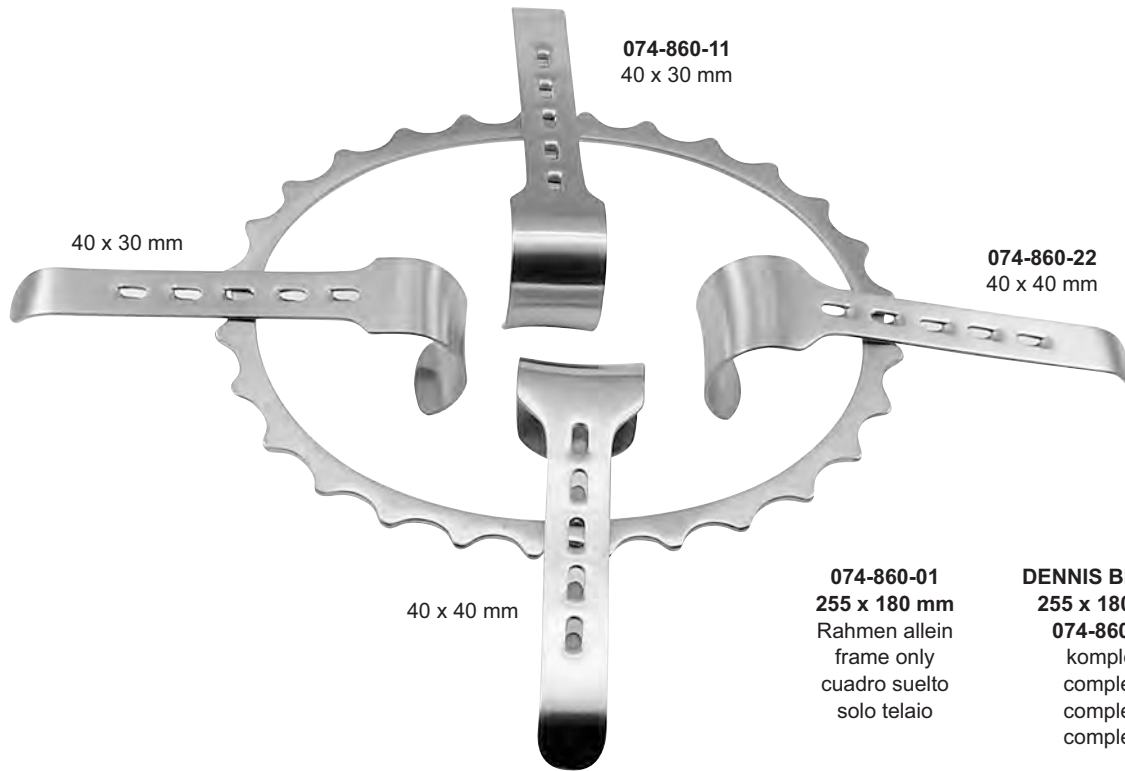
074-859-07
38 x 102 mm

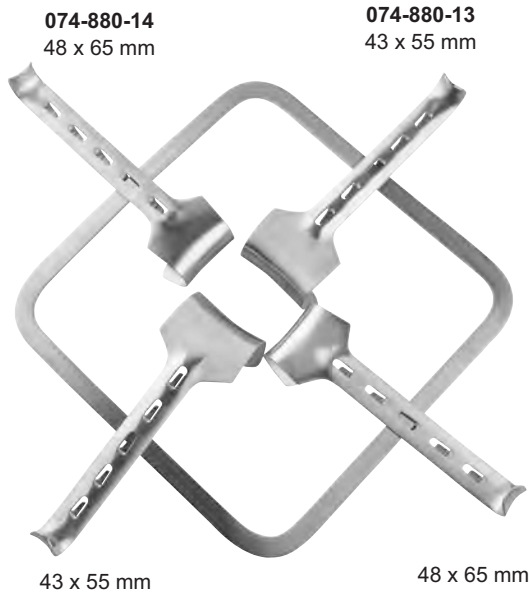


074-859-08
57 x 89 mm



074-859-09
57 x 114 mm





074-880-14
48 x 65 mm

074-880-13
43 x 55 mm

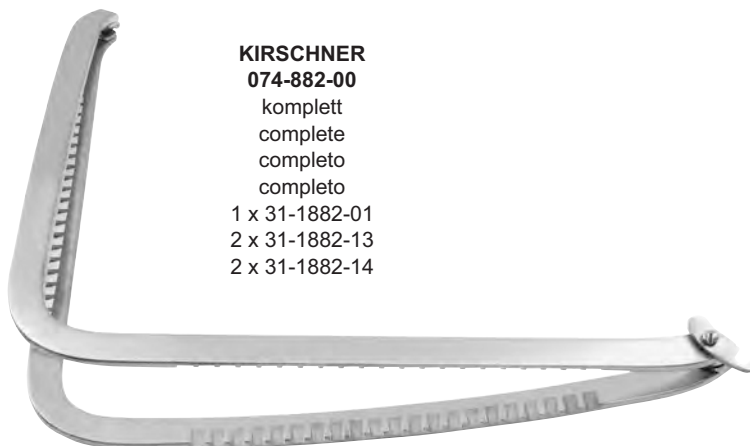
43 x 55 mm

48 x 65 mm

074-880-01 250 x 250 mm
074-880-02 300 x 320 mm
074-880-03 300 x 380 mm
 Rahmen allein
 frame only
 cuadro suelto
 solo telaio

KIRSCHNER
074-880-00
 komplett
 complete
 completo
 completo
 1 x 31-1880-01
 2 x 31-1880-13
 2 x 31-1880-14

074-882-01
 255 x 255 mm
 zusammenlegbarer Rahmen, allein
 folding frame, only
 cuadro plegable, suelto
 telaio pieghevole, solo



KIRSCHNER
074-882-00
 komplett
 complete
 completo
 completo
 1 x 31-1882-01
 2 x 31-1882-13
 2 x 31-1882-14



43 x 55 mm **074-880-13**
 48 x 65 mm **074-880-14**
 80 x 90 mm **074-880-15**
 90 x 65 mm **074-880-16**
 98 x 95 mm **074-880-17**

KIRSCHNER



KIRSCHNER
60 x 82 mm
074-880-11

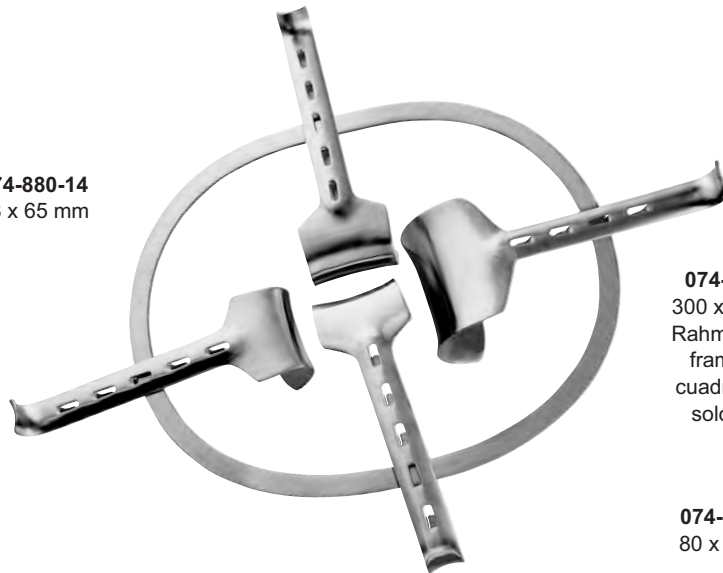


KIRSCHNER-BALFOUR
83 x 82 mm
074-880-12



KIRSCHNER
98 x 51 mm **074-880-20**
105 x 38 mm **074-880-21**

074-880-14
48 x 65 mm

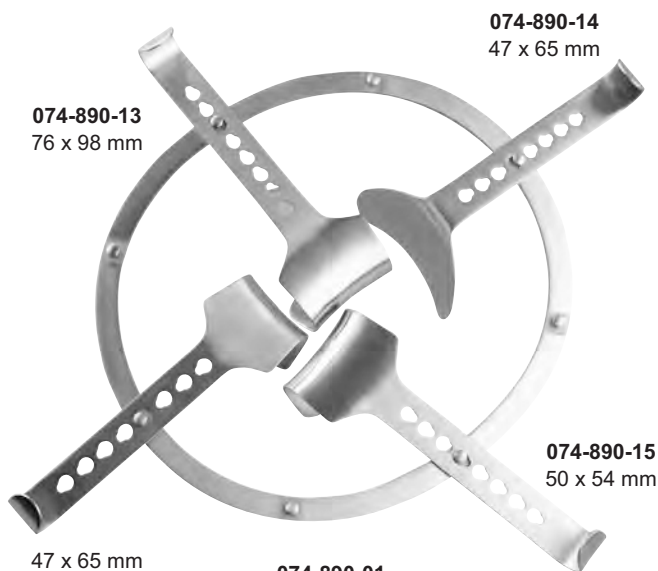


074-890-00
300 x 240 mm
Rahmen allein
frame only
cuadro suelto
solo telaio

074-880-15
80 x 90 mm

KIRSCHNER, oval
074-884-00

komplett, complete, completo, comple to
1 x 31-1884-01
3 x 31-1884-14
1 x 31-1884-15
1 x 31-1884-20
1 x 31-1884-21



074-890-13
76 x 98 mm

074-890-14
47 x 65 mm

074-890-15
50 x 54 mm

47 x 65 mm

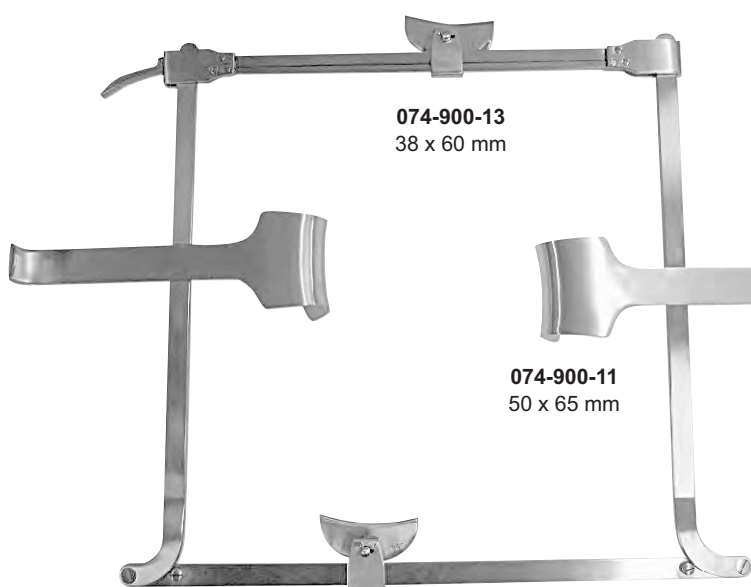
074-890-01
275 x 250 mm
Rahmen allein
frame only
cuadro suelto
solo telaio



074-890-11
98 x 52 mm

074-890-12
105 x 35 mm

074-900-01
300 x 300 mm
zusammenlegbarer Rahmen, allein
folding frame, only
cuadro plegable, suelto
telaio pieghevole, solo



074-900-13
38 x 60 mm

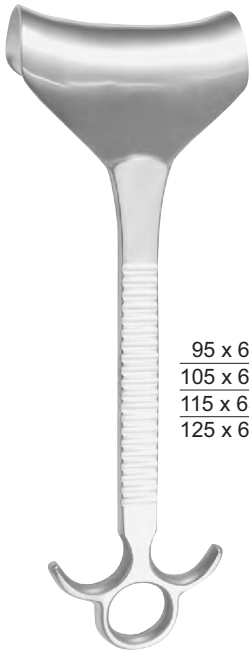
074-900-11
50 x 65 mm



FRANZ
074-900-00
komplett
complete
completo
completo

38 x 60 mm **074-900-13**
45 x 80 mm **074-900-14**

50 x 65 mm **074-900-11**
60 x 85 mm **074-900-12**



DOYEN
28,0 cm, 11"

95 x 60 mm	074-910-11
105 x 65 mm	074-910-12
115 x 65 mm	074-910-13
125 x 65 mm	074-910-14

für / for / para / per
074-910-11
074-910-14

Kette mit Gewicht
Chain with weight
Cadena con pesa
Catena con peso



074-915-30
78,5 cm, 31"

53,0 cm, 21"

66,0 cm, 26"

Befestigungsgestell
Mounting frame
Bastidor para la fijación
Telaio di supporto per il fissaggio

ROCHARD
074-920-01

53,0 cm, 21"

66,0 cm, 26"

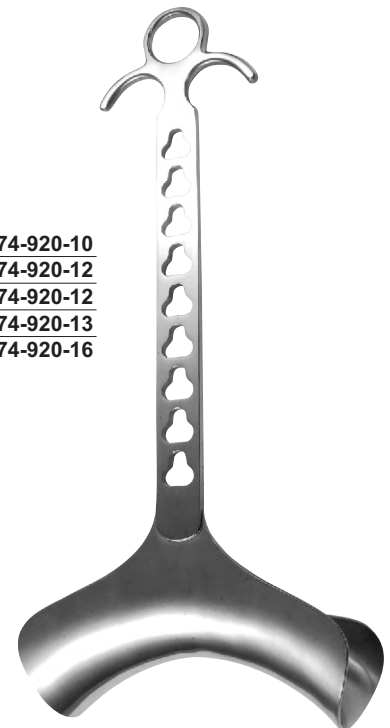
Befestigungsgestell
Mounting frame
Bastidor para la fijación
Telaio di supporto per il fissaggio

ROCHARD
074-920-02



ROCHARD
28,0 cm, 11"
074-920-20

95 x 48 mm	074-920-10
105 x 48 mm	074-920-12
115 x 48 mm	074-920-12
125 x 48 mm	074-920-13
155 x 48 mm	074-920-16



ROCHARD
28,0 cm, 11"

Bauchspatel
Abdominal Spatulas
Espátulas abdominales
Spatole addominali



biegsam
malleable
maleable
malleabile

200 x 6 mm **078-210-06**
200 x 12 mm **078-210-12**
200 x 17 mm **078-210-17**
200 x 20 mm **078-210-20**
200 x 25 mm **078-210-25**

RIBBON



biegsam
malleable
maleable
malleabile

330 x 13 mm **078-170-13**
330 x 25 mm **078-170-25**
330 x 32 mm **078-170-32**
330 x 40 mm **078-170-40**
330 x 50 mm **078-170-50**

RIBBON



biegsam
malleable
maleable
malleabile

280 x 25/30 mm **078-200-01**
300 x 37/45 mm **078-200-02**
300 x 40/50 mm **078-200-03**

RIBBON

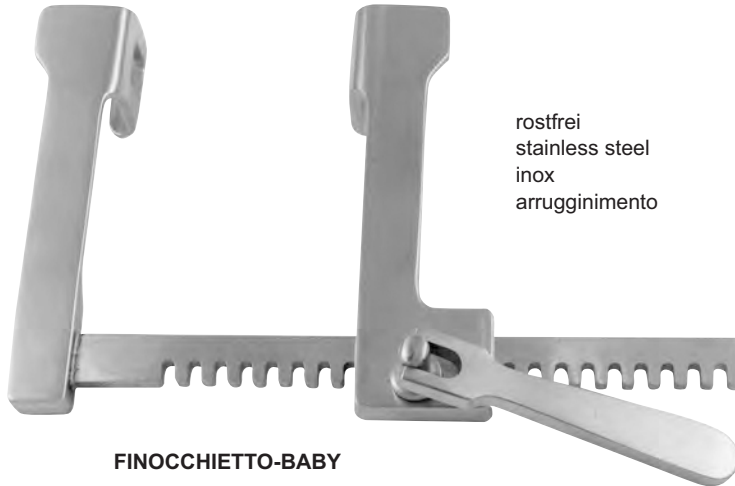


biegsam
malleable
maleable
malleabile

TUFFIER
200 x 25/17 mm
078-220-20



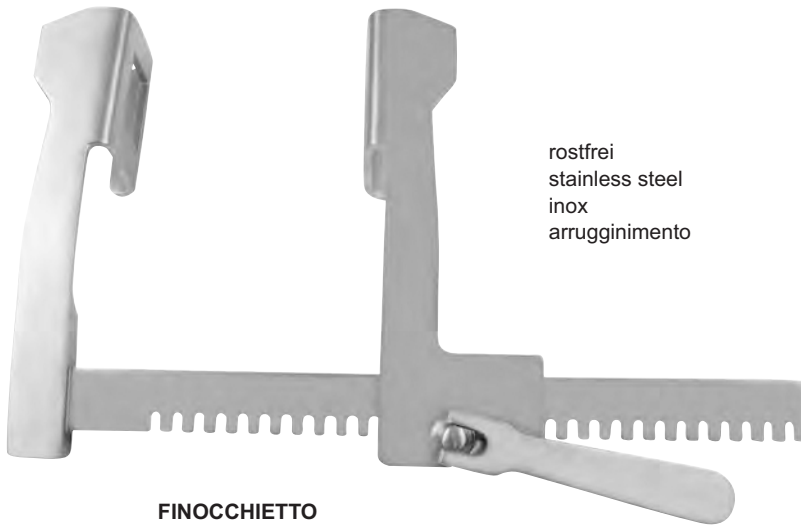
REVERDIN
280 x 45/60 mm
078-230-28



rostfrei
stainless steel
inox
arrugginimento

FINOCCHIETTO-BABY

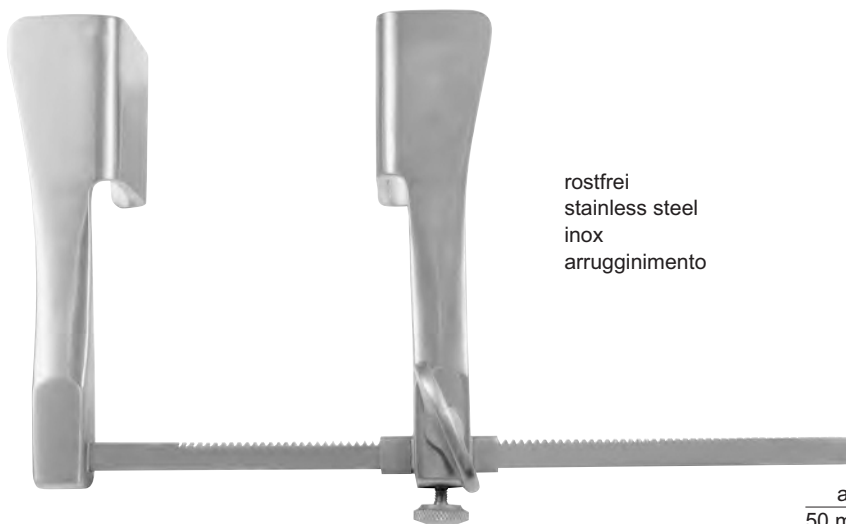
a	b	c	
18 mm	20 mm	75 mm	140-100-01



rostfrei
stainless steel
inox
arrugginimento

FINOCCHIETTO

a	b	c	
40 mm	40 mm	165 mm	140-100-02
45 mm	65 mm	200 mm	140-100-03
70 mm	65 mm	250 mm	140-100-04



rostfrei
stainless steel
inox
arrugginimento

TUFFIER

a	b	c	
50 mm	45 mm	165 mm	140-150-01

Sonden
Probes
Sondas
Sonde



Ø 1,0 mm Ø 2,0 mm

11,5 cm, 4 ¹ / ₂ "	080-000-11	080-004-11
13,0 cm, 5"	080-000-13	080-004-13
14,5 cm, 5 ³ / ₄ "	080-000-14	080-004-14
16,0 cm, 6 ¹ / ₄ "	080-000-16	080-004-15
18,0 cm, 7"	080-000-18	080-004-18
20,0 cm, 8"	080-000-20	080-004-20

Ø 2,0 mm



11,5 cm, 4 ¹ / ₂ "	080-013-11
13,0 cm, 5"	080-013-13
14,5 cm, 5 ³ / ₄ "	080-013-14
16,0 cm, 6 ¹ / ₄ "	080-013-16
18,0 cm, 7"	080-013-18
20,0 cm, 8"	080-013-20

Ø 1,0 mm



Silber
Silver
Plata
Argento

STACKE
10,5 cm, 4¹/₈"
080-033-10



Myrtenblattsonden
Myrtle leaf probes
Sondas para mirto
Sonde a foglia di mirto

11,5 cm, 4 ¹ / ₂ "	080-027-11
13,0 cm, 5"	080-027-13
14,5 cm, 5 ³ / ₄ "	080-027-14
16,0 cm, 6 ¹ / ₄ "	080-027-16
18,0 cm, 7"	080-027-18
20,0 cm, 8"	080-027-20



NÉLATON
16,0 cm, 6¹/₄"
080-120-16



DOYEN
14,5 cm, 5³/₄"
080-117-14



BRODIE
20,0 cm, 8"
080-126-20

Ø 3,5 mm

Ø 3,5 mm



11,5 cm, 4 1/2"	080-110-11
13,0 cm, 5"	080-110-13
14,5 cm, 5 3/4"	080-110-14
16,0 cm, 6 1/4"	080-110-16
18,0 cm, 7"	080-110-18
20,0 cm, 8"	080-110-20

Ø 3,3 mm



13,0 cm, 5"	080-122-13
14,5 cm, 5 3/4"	080-122-14
16,0 cm, 6 1/4"	080-122-16
18,0 cm, 7"	080-122-18



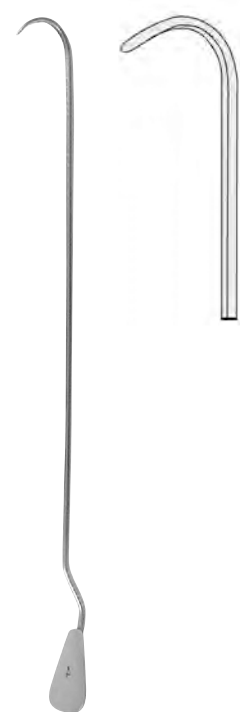
LOCKHART-MUMMERY
16,5 cm, 6 1/2"
080-130-01



LOCKHART-MUMMERY
16,5 cm, 6 1/2"
080-130-02



LOCKHART-MUMMERY
16,5 cm, 6 1/2"
080-130-03



LOCKHART-MUMMERY
16,5 cm, 6 1/2"
080-130-04

Watteträger
 Cotton Applicators
 Porta-algodones
 Porta-cotone



FEIN
 28,0 cm, 11"
 080-264-28



UKERMANN
 16,0 cm, 6 1/4"
 080-260-16



JOBSON-HORNE
 18,0 cm, 7"
 080-262-18



12,0 cm, 4 3/4" **080-271-12** Ø 0,9 mm
 14,0 cm, 5 3/4" **080-271-14** Ø 0,9 mm
 16,5 cm, 6 1/4" **080-271-16** Ø 1,1 mm
 18,0 cm, 7" **080-271-18** Ø 1,2 mm

FARRELL
 (LATHBURY)



12,0 cm, 4 3/4" **080-270-12** Ø 0,9 mm
 14,0 cm, 5 3/4" **080-270-14** Ø 0,9 mm
 16,5 cm, 6 1/4" **080-270-16** Ø 1,1 mm
 18,0 cm, 7" **080-270-18** Ø 1,2 mm

FARRELL



080-150-01
 Metalletui
 Metal case
 Estuche de metal
 Scatola in metallo
 135 x 100 x 25 mm



Ø 3,0 mm
080-150-03



Ø 6,0 mm
080-150-06

NABATOFF
080-150-00
 komplett
 complete
 completo
 completo



Ø 9,0 mm
080-150-09

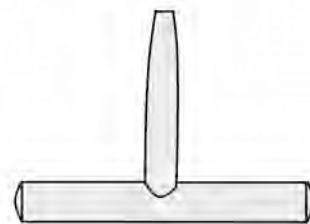


080-150-21
 Zugseil
 Cable
 Cable
 Fune



Ø 12,0 mm
080-150-12

080-150-22
 Kunststoff-Sondenspitze
 Plastic probe tip
 Extremidad de sonda de plástico
 Punta in materia plastica



080-150-20
 Handgriff
 Handle
 Mango
 Manico



Ø 3,0 mm	084-110-30
Ø 3,5 mm	084-110-35
Ø 4,0 mm	084-110-40
Ø 4,5 mm	084-110-45
Ø 5,0 mm	084-110-50
Ø 5,5 mm	084-110-55
Ø 6,0 mm	084-110-60

STANDARD
11,0 cm, 4³/₈"



Ø 3,0 mm	084-112-30
Ø 3,5 mm	084-112-35
Ø 4,0 mm	084-112-40
Ø 4,5 mm	084-112-45
Ø 5,0 mm	084-112-50
Ø 5,5 mm	084-112-55
Ø 6,0 mm	084-112-60

STANDARD
12,0 cm, 4³/₄"



Ø 3,0 mm	084-114-30
Ø 3,5 mm	084-114-35
Ø 4,0 mm	084-114-40
Ø 4,5 mm	084-114-45
Ø 5,0 mm	084-114-50
Ø 5,5 mm	084-114-55
Ø 6,0 mm	084-114-60

STANDARD
12,0 cm, 4³/₄"

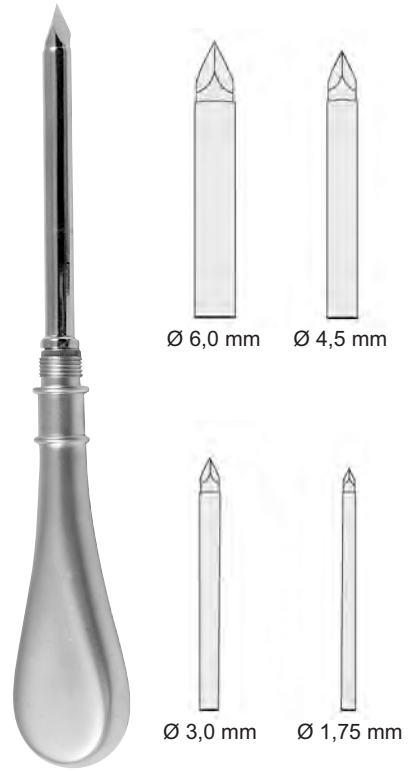


Ø 7,3 mm	084-118-07
Ø 8,7 mm	084-118-09
Ø 12,0 mm	084-118-12

HURWITZ



UNIVERSAL
084-100-03



UNIVERSAL
084-100-04

140 mm

LANDAU
Ø 2,0 mm
084-160-16

LANDAU
Ø 2,0 mm
084-161-16

DAVIDSON
Ø 6,0 mm
084-164-18

BUELAU
Ø 8,0 mm
084-124-24

Trokare
Trocars
Trócares
Trequarti



Ø 6,0 mm **084-128-06**
Ø 8,0 mm **084-128-08**

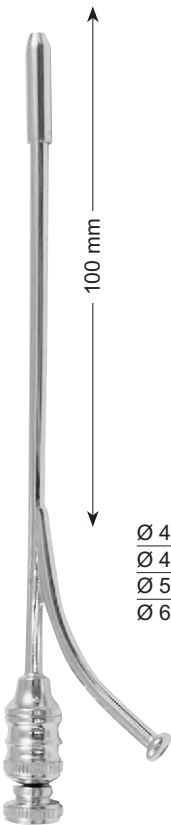
CAMPBELL
16,0 cm, 6 1/4"



80 mm

Ø 7,5 mm **084-120-01**
Ø 9,0 mm **084-120-02**
Ø 10,5 mm **084-120-03**
Ø 12,0 mm **084-120-04**

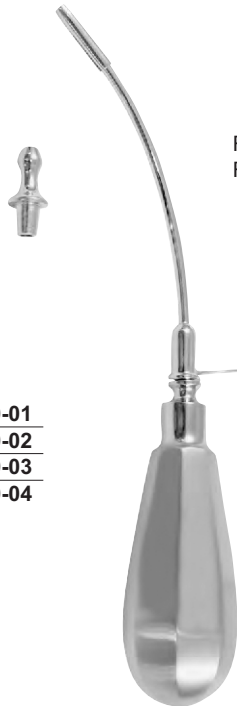
NELSON
21,0 cm, 8 1/2"



100 mm

Ø 4,0 mm **084-140-01**
Ø 4,6 mm **084-140-02**
Ø 5,5 mm **084-140-03**
Ø 6,5 mm **084-140-04**

OCHSNER
14,0 cm, 5 1/2"



Record Konus
Record cone

Ø 3,0 mm **084-180-30**
Ø 4,0 mm **084-180-40**
Ø 5,0 mm **084-180-50**

PIERCE
16,0 cm, 6 1/4"



Ø 2,25 mm

COAKLEY
14,0 cm, 5 1/4"
084-190-14

Ø 4,0 mm



KRAUSE
16,0 cm, 6 1/4"

LICHTWITZ
Kieferhöhlentrokare
Antrum trocars
Trócares para el seno maxilar
Trequarti per puntura del seno mascellare

Ø 3,0 mm	084-184-30
Ø 4,0 mm	084-184-40
Ø 5,0 mm	084-184-50
Ø 5,5 mm	084-184-55

Ø 1,8 mm



LICHTWITZ
20,0 cm, 8"
084-170-00



LICHTWITZ
11,0 cm, 4 1/2"
084-172-00



DOUGLAS
Ø 3,0 mm
084-175-00



POOLE
22,0 cm, 8 5/8"
Ø 6,0 mm **085-020-06**
Ø 10,0 mm **085-020-10**



POOLE
22,0 cm, 8 5/8"
Ø 6,0 mm **085-021-06**
Ø 8,0 mm **085-021-08**

Saugrohre
Suction Tubes
Tubos para aspiración
Tubi aspirazione



auswechselbare Spitze
interchangeable tip
punta intercambiabiles
tipo intercambiabile



COUPLAND
17,0 cm, 6³/₄"
085-010-17



YANKAUER
27,0 cm, 10⁵/₈"
085-000-27



DE BAKEY
27,0 cm, 10⁵/₈"
085-008-27



ANTHONY
26,0 cm, 10¹/₄"
085-007-26



ANDREWS-PYNCHON
24,0 cm, 9¹/₂"
085-006-24



COOLEY
35,0 cm, 13³/₄"
Ø 8,0 mm
085-024-02



COOLEY
30,0 cm, 11³/₄"
Ø 7,0 mm
085-024-03



COOLEY
31,0 cm, 11³/₄"
Ø 10,0 mm
085-024-04



COOLEY
33,0 cm, 13"
Ø 8,0 mm
085-024-01



BYRD
20,0 cm, 8"
Ø 1,5 mm **085-012-15**
Ø 2,5 mm **085-012-25**
Ø 3,5 mm **085-012-35**

Ø 4,0 mm



ADSON
21,0 cm, 8 1/4"
085-050-21



MAGILL
17,5 cm, 6 5/8"
Ø 1,0 mm **085-060-01**
Ø 2,0 mm **085-060-02**
Ø 3,0 mm **085-060-03**
Ø 4,0 mm **085-060-04**



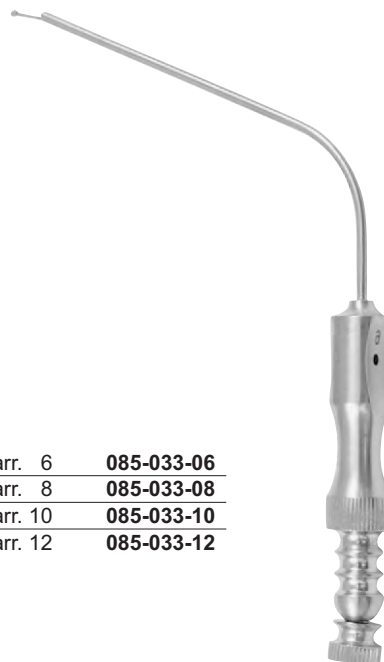
FRAZIER
19,0 cm, 7 1/2"

Charr. 6 **085-030-06**
Charr. 8 **085-030-08**
Charr. 10 **085-030-10**
Charr. 12 **085-030-12**



FERGUSON
18,0 cm, 7"

Charr. 6 **085-033-06**
Charr. 8 **085-033-08**
Charr. 10 **085-033-10**
Charr. 12 **085-033-12**



POPPEN
13,0 cm, 5"

Charr. 6 **085-034-06**
Charr. 8 **085-034-08**
Charr. 10 **085-034-10**
Charr. 12 **085-034-12**

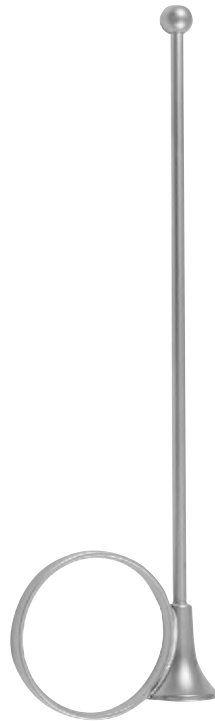
Spezialkanülen
Special Needles
Agujas especiales
Aghi speciali



LUER-LOCK

Packung zu 12 Stück
Package of 12 pcs.
Cajecita de 12 pzs.
Confezione da 12 pezzi

Ø 0,90 x 38 mm	086-000-01
Ø 0,80 x 32 mm	086-000-02
Ø 0,70 x 32 mm	086-000-03
Ø 0,65 x 28 mm	086-000-04
Ø 0,60 x 25 mm	086-000-05
Ø 0,50 x 23 mm	086-000-06
Ø 0,45 x 20 mm	086-000-07



IOWA
14,0 cm, 5 1/4"
086-150-14

Ø 1,0 x 185 mm

086-150-01
Nadel
Needle
Aguja
Aghi



MOCK
6,0 cm, 2 3/8"
086-200-06



SCHMID
15,0 cm, 6"



Ø 3,0 mm
086-140-03



Ø 4,0 mm
086-140-04



Ø 5,0 mm
086-140-05



Ø 6,0 mm
086-140-06

Gefäßspülkanülen, biegsam
Vascular irrigation cannulae, malleable
Cánulas vasculares para irrigación, maleables
Aghi vascolari per irrigazione, malleabili



Ø 1,20 x 80 mm **086-210-12**
Ø 1,50 x 80 mm **086-210-15**



Ø 2,00 x 100 mm **086-180-10**
Ø 2,00 x 120 mm **086-180-12**
Ø 2,00 x 150 mm **086-180-15**

VERESS

Kanülen zur Sternalpunktion
Sternum puncture needles
Agujas para la punción del esternón
Aghi per puntura dello sterno



KLIMA-ROSSEGER
Ø 1,60 x 40 mm
086-060-16

Kanülen zur Lumbalpunktion
Lumbar puncture needles
Agujas para punción lumbar
Aghi per punture lombari



Ø 0,8 x 70/80/90/100/120 mm **086-130-01**
Ø 1,0 x 70/80/90/100/120 mm **086-130-02**
Ø 1,2 x 70/80/90/100/120 mm **086-130-03**
Ø 1,4 x 70/80/90/100/120 mm **086-130-04**
Ø 1,6 x 70/80/90/100/120 mm **086-130-05**
Ø 1,8 x 70/80/90/100/120 mm **086-130-06**
Ø 2,0 x 70/80/90/100/120 mm **086-130-07**

BIER

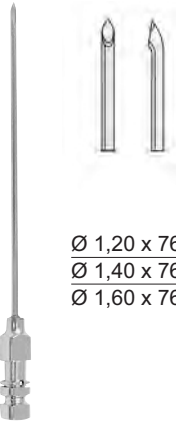
Kanülen zur Lumbalpunktion
 Lumbar puncture needles
 Agujas para punción lumbar
 Aghi per punture lombari



QUINKE

- Ø 1,20 x 76 mm **086-120-01**
- Ø 1,20 x 89 mm **086-120-02**
- Ø 1,00 x 76 mm **086-120-03**
- Ø 1,00 x 89 mm **086-120-04**
- Ø 0,70 x 76 mm **086-120-05**
- Ø 0,70 x 50 mm **086-120-06**
- Ø 0,70 x 89 mm **086-120-07**

Kanülen zur Lumbalpunktion
 Lumbar puncture needles
 Agujas para punción lumbar
 Aghi per punture lombari



TUHOJ

- Ø 1,20 x 76 mm **086-090-12**
- Ø 1,40 x 76 mm **086-090-14**
- Ø 1,60 x 76 mm **086-090-16**

Kanülen zur Leberblindpunktion
 Liver blind puncture needles
 Agujas para punción ciega del hígado
 Aghi per punture cieca del fegato



MENGHINI

- Ø 1,00 x 35 mm **086-115-01**
- Ø 1,00 x 70 mm **086-115-02**
- Ø 1,20 x 70 mm **086-115-03**
- Ø 1,20 x 100 mm **086-115-04**
- Ø 1,40 x 70 mm **086-115-05**
- Ø 1,40 x 100 mm **086-115-06**
- Ø 1,60 x 70 mm **086-115-07**
- Ø 1,60 x 100 mm **086-115-08**

Kanülen zur gezielten Leberpunktion
 Needles for controlled liver puncture
 Agujas para la punción del hígado bajo el control laparoscópico
 Aghi per la punture controllata del fegato



MENGHINI

- Ø 1,40 x 168 mm **086-117-14**
- Ø 1,80 x 168 mm **086-117-18**

Trokare für Kanülen
 Trocars for needles
 Trocares para agujas
 Trequarti oer aghi



- Ø 1,40 x 168 mm **086-230-14**
- Ø 1,80 x 168 mm **086-230-18**



- 1 ml **087-051-01**
- 2 ml **087-051-02**
- 5 ml **087-051-05**
- 10 ml **087-051-10**
- 20 ml **087-051-20**
- 50 ml **087-051-50**



- 1 ml **087-001-01**
- 2 ml **087-001-02**
- 5 ml **087-001-05**
- 10 ml **087-001-10**
- 20 ml **087-001-20**
- 50 ml **087-001-50**



- 1 ml **087-061-01**
- 2 ml **087-061-02**



LUER

- 1 ml **087-050-01**
- 2 ml **087-050-02**
- 5 ml **087-050-05**
- 10 ml **087-050-10**
- 20 ml **087-050-20**
- 50 ml **087-050-50**



LUER-LOCK

- 1 ml **087-000-01**
- 2 ml **087-000-02**
- 5 ml **087-000-05**
- 10 ml **087-000-10**
- 20 ml **087-000-20**
- 50 ml **087-000-50**



LUER-LOCK

- 2 ml **087-055-02**
- 5 ml **087-055-05**
- 10 ml **087-055-10**

INSULIN LUER



- 1 ml **087-060-01**
- 2 ml **087-060-02**



50 ml **087-071-05**
100 ml **087-071-10**
150 ml **087-071-15**
200 ml **087-071-20**



10 ml **087-081-10**
20 ml **087-081-20**
30 ml **087-081-30**
50 ml **087-081-50**



50 ml **087-070-05**
100 ml **087-070-10**
150 ml **087-070-15**
200 ml **087-070-20**

Zwischenstück, LUER-LOCK weiblich
 Connecting piece, LUER-LOCK female
 Pieza de conexión, LUER-LOCK hembra
 Raccordo, LUER-LOCK femmina



087-911-00

Zwischenstück, LUER-LOCK männlich
 Connecting piece, LUER-LOCK male
 Pieza de conexión, LUER-LOCK masculino
 Raccordo, LUER-LOCK maschio



087-930-02

Zwischenstück, LUER-LOCK männlich
 Connecting piece, LUER-LOCK male
 Pieza de conexión, LUER-LOCK masculino
 Raccordo, LUER-LOCK maschio

Ø 6 mm Ø 8 mm



087-912-06 087-912-08

Zwischenstück, LUER-LOCK weiblich
 Connecting piece, LUER-LOCK female
 Pieza de conexión, LUER-LOCK hembra
 Raccordo, LUER-LOCK femmina



087-913-00

Zwischenstück, LUER-LOCK männlich
 Connecting piece, LUER-LOCK male
 Pieza de conexión, LUER-LOCK masculino
 Raccordo, LUER-LOCK maschio



087-935-00

Durchflußhahn, LL männl. – LL weibl.
 Stopcock, LL male – LL female
 Llave, LL masculino – LL hembra
 Rubinetto, LL maschio – LL femmina



087-939-00

Durchflußhahn, LL weiblich
 Stopcock, LL female
 Llave, LL hembra
 Rubinetto, LL femmina



087-920-00

Dreiweghahn, 1 LL männl. – 2 LL weibl.
 Three-way-stopcock, 1 LL male – 2 LL female
 Llave de 3 vías, 1 LL masculino – 2 LL hembra
 Rubinetto a tre vie, 1 LL maschio – 2 LL femmina



087-922-00

Dreiweghahn, 3 LL weiblich
 Three-way-stopcock, 3 LL female
 Llave de 3 vías, 3 LL hembra
 Rubinetto a tre vie, 3 LL femmina



087-926-00

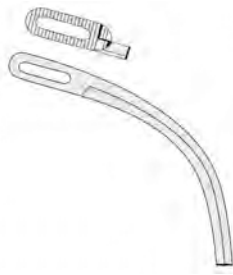
Nierensteinzangen, Gallensteinzangen
 Kidney Stone Forceps, Gall Stone Forceps
 Pinzas para los cálculos renales, Pinzas para los cálculos biliares
 Pinze per calcoli renali, Pinze per calcoli biliari



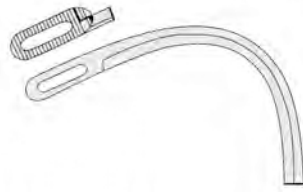
RANDALL



23,0 cm, 9"
158-001-01



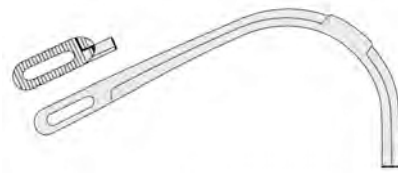
22,0 cm, 8⁵/₈"
158-001-02



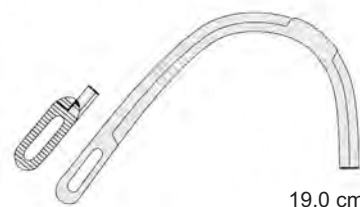
22,0 cm, 8⁵/₈"
158-001-03



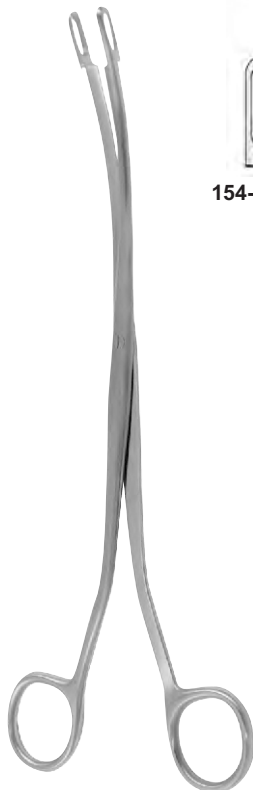
22,0 cm, 8⁵/₈"
158-001-04



19,0 cm, 7¹/₂"
158-001-05



19,0 cm, 7¹/₂"
158-001-06



DESJARDINS
 23,0 cm, 9"



154-001-01



154-001-02



MIXER
 22,0 cm, 8⁵/₈"
154-021-22

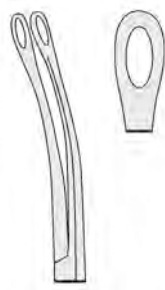


MAYO BLAKE
 20,0 cm, 8"
154-008-20

20,0 cm, 8"
154-009-20



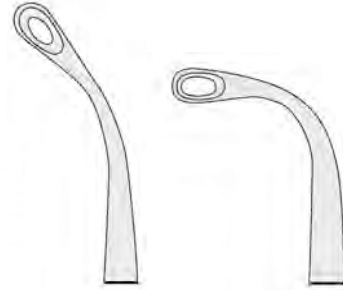
BLAKE
20,0 cm, 8"
154-006-20



20,0 cm, 8"
154-005-20



TURNER-WARWICK
18,0 cm, 7"



154-031-01

154-031-03

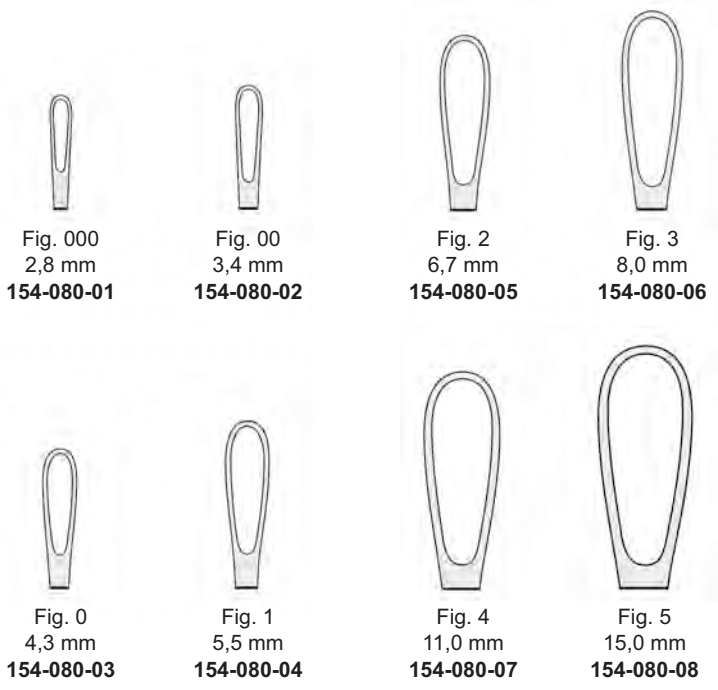


CZERNY
24,5 cm, 9⁵/₈"
154-039-24

Gallensteinlöffel
 Gall Stone Scoops
 Cucharillas para los cálculos biliares
 Cucchiari per calcoli biliari



LUER-KÖRTE
 24,0 cm, 9 1/2"



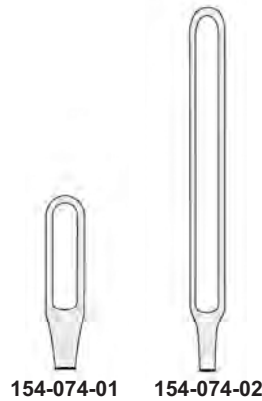
FERGUSSON
 21,5 cm, 8 1/2"
 154-070-01



MAYO
 27,0 cm, 10 5/8"
 154-072-01



MAYO
 27,0 cm, 10 5/8"



MOYNIHAN
 34,0 cm, 13 3/8"
 154-076-34



MAYO
 32,0 cm, 12¹/₂"
 154-078-32



OCHSNER
 35,0 cm, 13³/₄"
 154-082-35



DESJARDINS
 28,0 cm, 11"



13 Char.
 154-056-13

18 Char.
 154-056-18

21 Char.
 154-056-21



MOORE
 30,0 cm, 12"
 154-084-30

Gallenblasenlöffel
 Gall bladder scoope
 Cuccharilla para la vesicula biliar
 Cucchiaino per colecisti



DESJARDINS
 28,0 cm, 11"



18 Char.
 154-058-18



21 Char.
 154-058-21




24 Char.
 154-058-24



27 Char.
 154-058-26



Ø 1,0 mm
154-050-01



Ø 2,0 mm
154-050-02



Ø 3,0 mm
154-050-03



Ø 4,0 mm
154-050-04



Ø 5,0 mm
154-050-05



Ø 6,0 mm
154-050-06



Ø 7,0 mm
154-050-07



Ø 8,0 mm
154-050-08



Ø 9,0 mm
154-050-09



Ø 10,0 mm
154-050-10



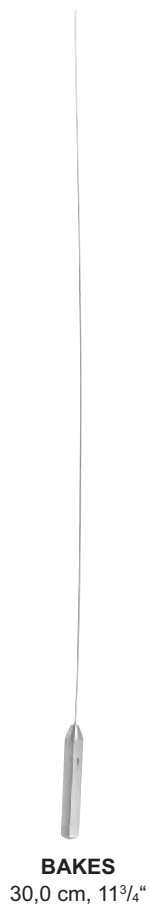
Ø 11,0 mm
154-050-11



Ø 12,0 mm
154-050-12

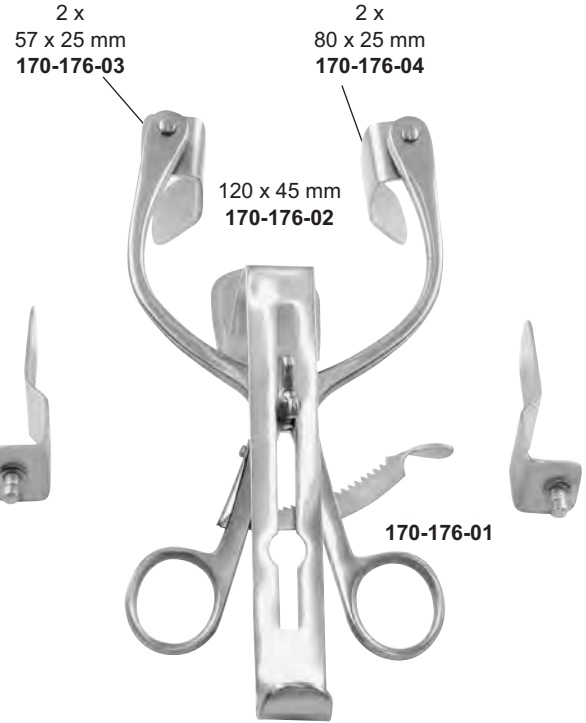


Ø 13,0 mm
154-050-13

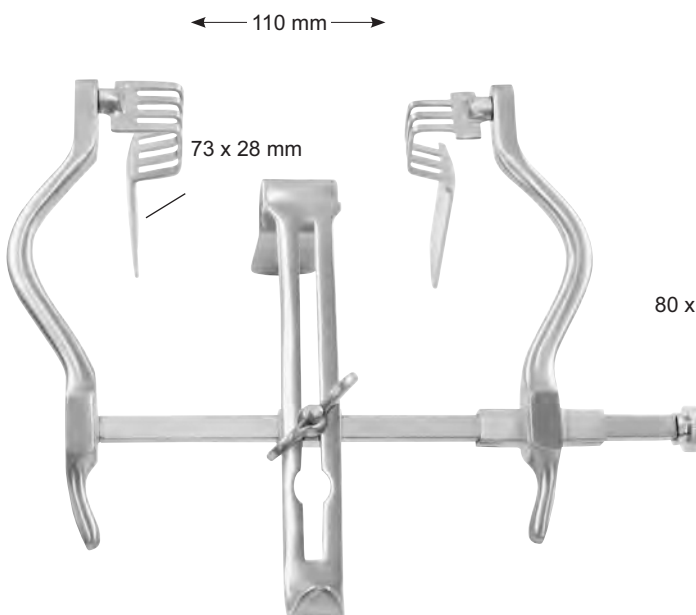




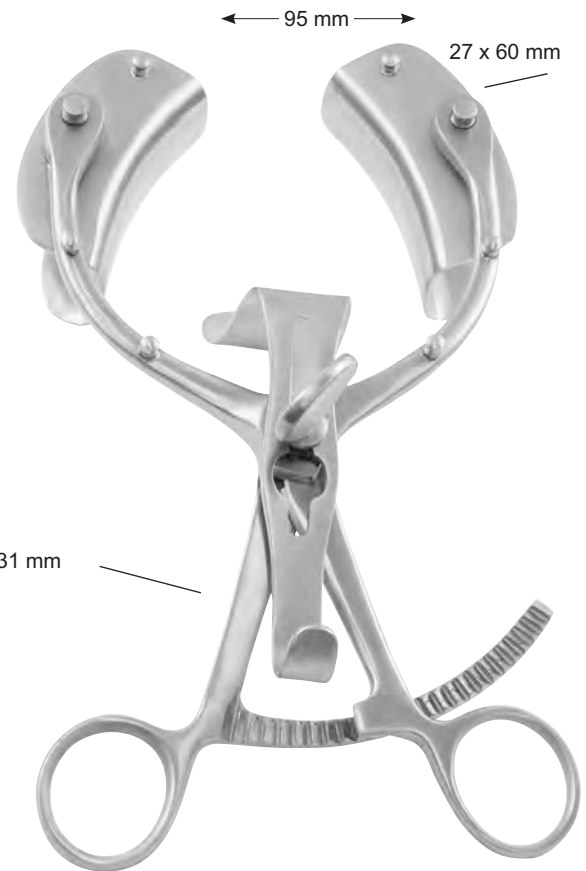
THOMSON-WALKER
170-182-00



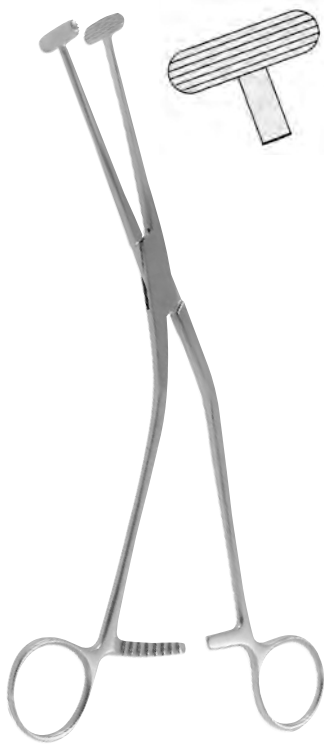
MILLIN
170-176-00



JUDD-MASSON
170-172-00



LEGUEU
170-160-00



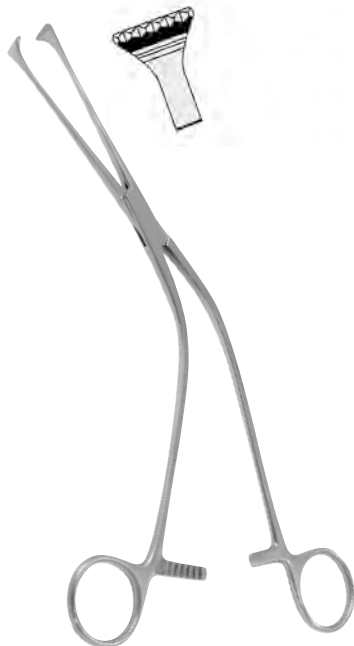
MILLIN
 23,0 cm, 9"
 170-073-23



MILLIN
 24,0 cm, 9½"
 170-071-24



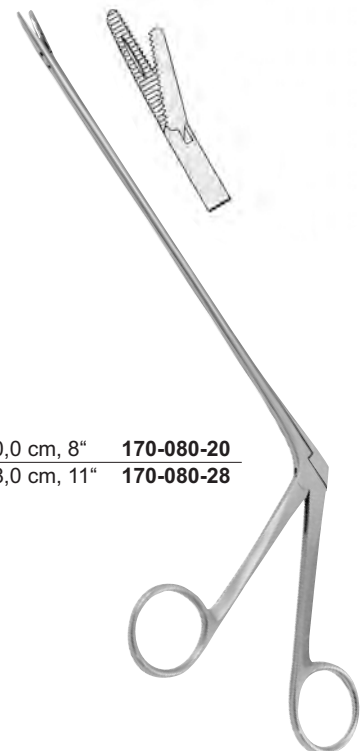
MILLIN
 24,0 cm, 9½"
 170-077-24



MILLIN
 23,0 cm, 9"
 170-075-23



MILLIN
 28,5 cm, 11¼"
 170-150-24



20,0 cm, 8" **170-080-20**
 28,0 cm, 11" **170-080-28**

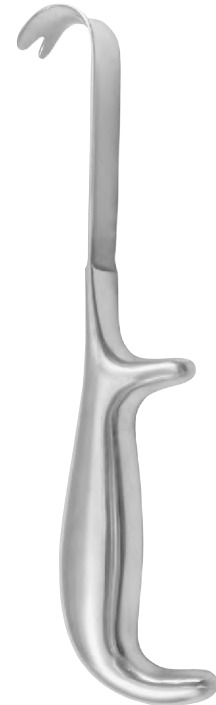
MATHIEU



YOUNG
21,0 cm, 8¹/₄"
170-230-21



YOUNG
22,0 cm, 8⁵/₈"
170-236-22



YOUNG
21,0 cm, 8¹/₄"
170-238-21



YOUNG
22,0 cm, 8⁵/₈"
170-240-22



90 x 35 mm

LEGUEU
26,0 cm, 10¹/₄"
170-250-26



90 x 61 mm

KOCHER
23,5 cm, 9¹/₄"
170-257-23



für Männer
 for men
 para hombres
 per uomini

Char. 8	170-650-08
Char. 10	170-650-10
Char. 12	170-650-12
Char. 14	170-650-14
Char. 16	170-650-16
Char. 18	170-650-18
Char. 20	170-650-20
Char. 22	170-650-22
Char. 24	170-650-24

29,0 cm, 11 1/2"



für Frauen
 for women
 para mujeres
 per donne

Char. 6	170-660-06
Char. 7	170-660-07
Char. 8	170-660-08
Char. 9	170-660-09
Char. 10	170-660-10
Char. 11	170-660-11
Char. 12	170-660-12
Char. 13	170-660-14
Char. 15	170-660-15
Char. 16	170-660-16
Char. 18	170-660-18
Char. 20	170-660-20
Char. 24	170-660-24

16,0 cm, 6 1/4"



STRAUSS
 11,0 cm, 4 1/3"
 170-349-11

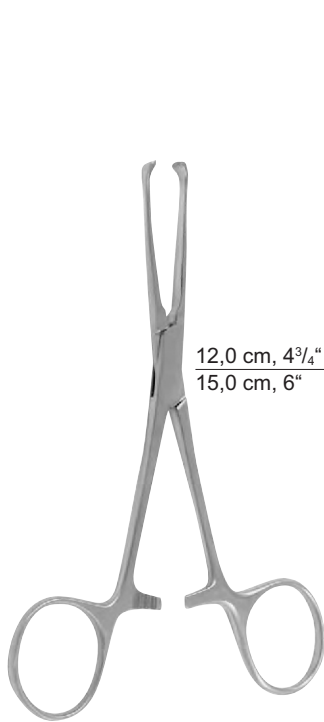


STOCKMANN
 8,0 cm, 3 1/4"
 170-345-08



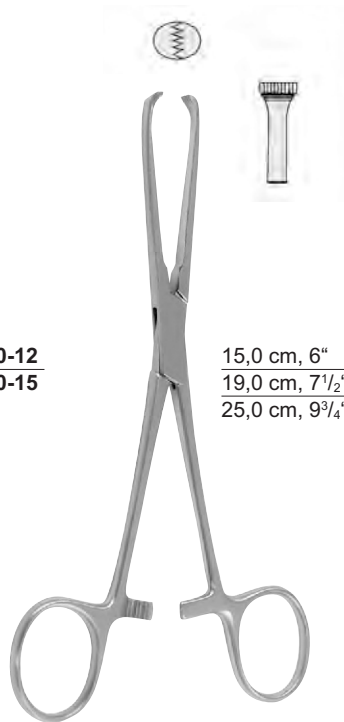
COMCO

Ø 8,0 mm	170-350-08
Ø 11,0 mm	170-350-11
Ø 13,0 mm	170-350-13
Ø 16,0 mm	170-350-16
Ø 21,0 mm	170-350-21
Ø 26,0 mm	170-350-26
Ø 32,0 mm	170-350-32



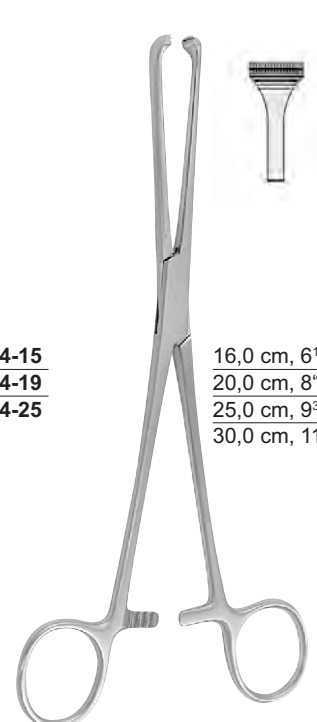
12,0 cm, 4³/₄" **160-000-12**
 15,0 cm, 6" **160-000-15**

ALLIS-BABY



15,0 cm, 6" **160-004-15**
 19,0 cm, 7¹/₂" **160-004-19**
 25,0 cm, 9³/₄" **160-004-25**

ALLIS



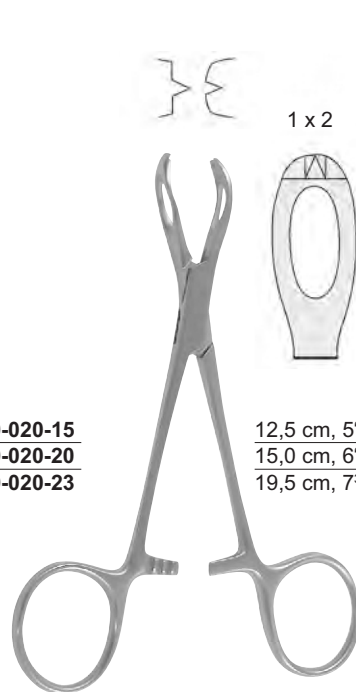
16,0 cm, 6¹/₄" **160-124-16**
 20,0 cm, 8" **160-124-20**
 25,0 cm, 9³/₄" **160-124-25**
 30,0 cm, 11³/₄" **160-124-30**

ALLIS-ATRAUMA



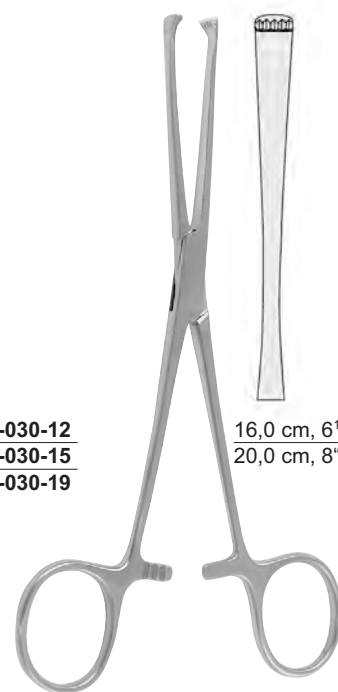
15,5 cm, 6" **160-020-15**
 20,0 cm, 8" **160-020-20**
 23,0 cm, 9" **160-020-23**

ALLEN



12,5 cm, 5" **160-030-12**
 15,0 cm, 6" **160-030-15**
 19,5 cm, 7³/₄" **160-030-19**

LANE



16,0 cm, 6¹/₄" **160-178-16**
 20,0 cm, 8" **160-178-20**

LOCKWOOD-ALLIS



15,0 cm, 6" 160-040-15
19,0 cm, 7½" 160-040-19

JUDD-ALLIS



LITTLEWOOD
18,5 cm, 7¼"
160-060-16



ALLIS-ADAIR
15,5 cm, 6"
160-010-15



BOYS-ALLIS
15,5 cm, 6"
160-012-15



THOMS-ALLIS
20,0 cm, 8"
160-050-20



ALLIS
20,0 cm, 8"
160-014-20



LOCKWOOD
 20,0 cm, 8"
 160-169-20



WILLIAMS
 16,0 cm, 6 1/4"
 160-070-16



16,0 cm, 6 1/4" **160-006-16**
 18,0 cm, 7" **160-006-18**
 20,0 cm, 8" **160-006-20**
 24,0 cm, 9 1/2" **160-006-24**



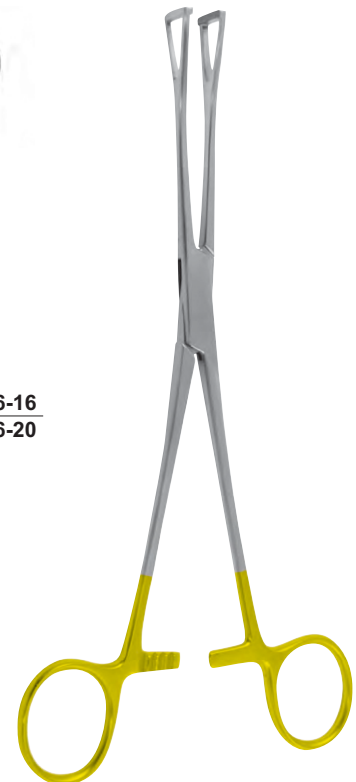
BABCOCK-ATRAUMA

16,0 cm, 6 1/4" **164-006-16**
 20,0 cm, 8" **164-006-20**

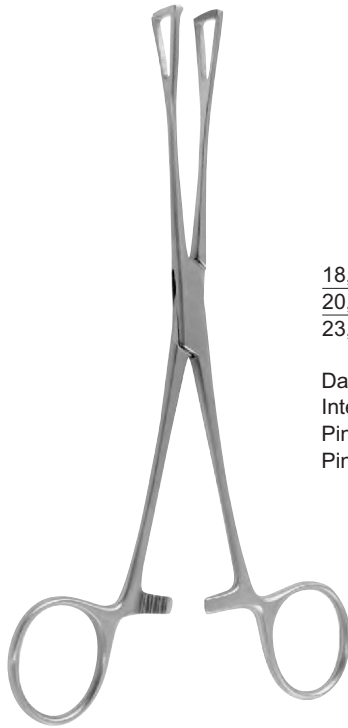


BABCOCK-T C

16,0 cm, 6 1/4" **161-006-16**
 20,0 cm, 8" **161-006-20**



DUVAL-TC
 20,0 cm, 8"
 161-170-20



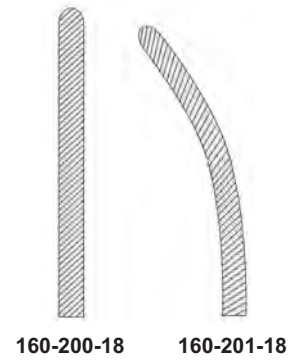
DUVAL

18,0 cm, 7"	160-170-18	
20,0 cm, 8"	160-170-20	160-172-20
23,0 cm, 9"		160-172-23

Darm- und Gewebefaßzangen
 Intestinal and Tissue Grasping Forceps
 Pinzas intestinales y para tejidos
 Pinze da presa per intestino e tessuti

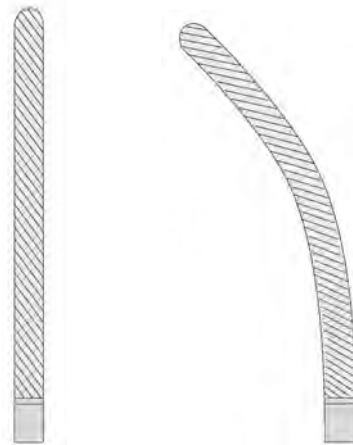


BABY-DOYEN
 18,0 cm, 7"



DOYEN

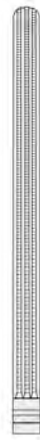
21,0 cm, 8 ¹ / ₄ "	160-210-21	21,0 cm, 8 ¹ / ₄ "	160-211-21
23,0 cm, 9"	160-210-23	23,0 cm, 9"	160-211-23



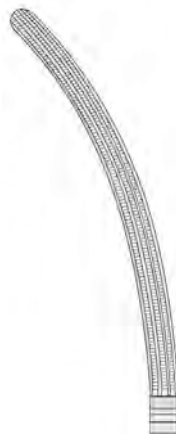
Darmklemmen
 Intestinal Clamp Forceps
 Pinzas-clamps intestinales
 Pinze intestinal i



DOYEN



21,0 cm, 8¹/₄" **164-210-21**
 23,0 cm, 9" **164-210-23**



21,0 cm, 8¹/₄" **164-211-21**
 23,0 cm, 9" **164-211-23**

mit atraumatischer Zahnung
 with atraumatic serration
 con bacos atraumáticas
 con morsi atraumatici



KOCHER



22,0 cm, 8⁵/₈" **160-234-22**
 25,0 cm, 9³/₄" **160-234-25**
 28,0 cm, 11" **160-234-28**

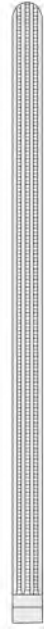


22,0 cm, 8⁵/₈" **160-235-22**
 25,0 cm, 9³/₄" **160-235-25**
 28,0 cm, 11" **160-235-28**



mit atraumatischer Zahnung
with atraumatic serration
con bacos atraumáticos
con morsi atraumatici

KOCHER



22,0 cm, 8⁵/₈" **164-234-22**
25,0 cm, 9³/₄" **164-234-25**
28,0 cm, 11" **164-234-28**



22,0 cm, 8⁵/₈" **164-235-22**
25,0 cm, 9³/₄" **164-235-25**
28,0 cm, 11" **164-235-28**



MAYO-ROBSON

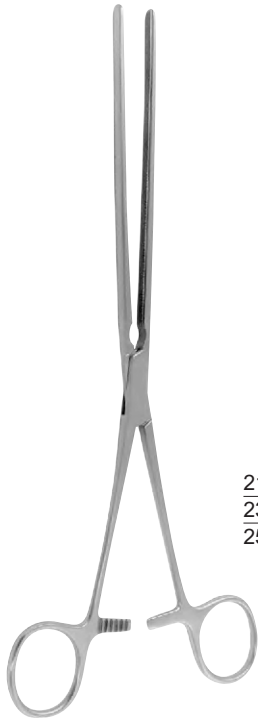


21,0 cm, 8¹/₄" **160-230-21**
23,0 cm, 9" **160-230-23**
25,0 cm, 9³/₄" **160-230-25**



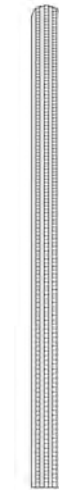
21,0 cm, 8¹/₄" **160-231-21**
23,0 cm, 9" **160-231-23**
25,0 cm, 9³/₄" **160-231-25**

Darmklemmen
 Intestinal Clamp Forceps
 Pinzas-clamps intestinales
 Pinze intestinali

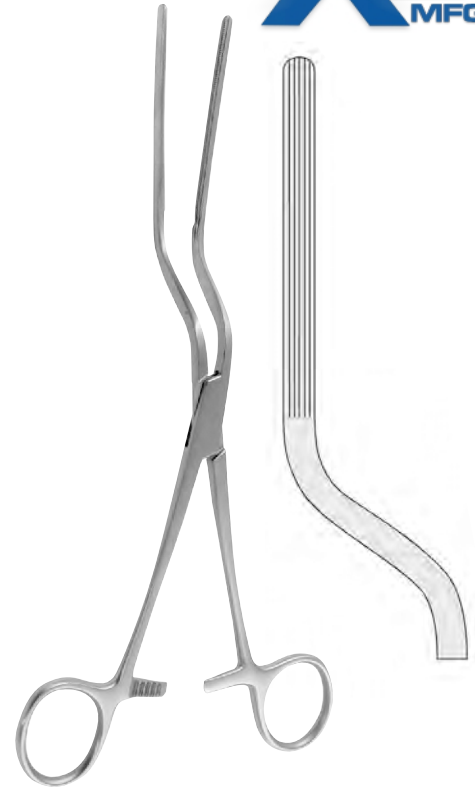


MAYO-ROBSON

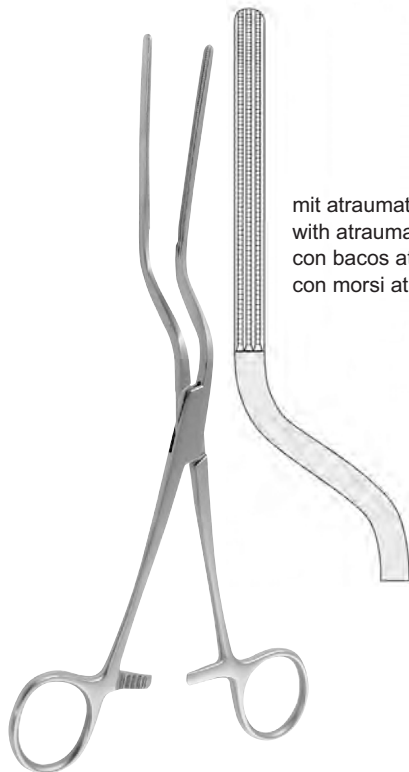
21,0 cm, 8¹/₄" **164-230-21**
 23,0 cm, 9" **164-230-23**
 25,0 cm, 9³/₄" **164-230-25**



mit atraumatischer Zahnung
 with atraumatic serration
 con bacos atraumáticas
 con morsi atraumatici

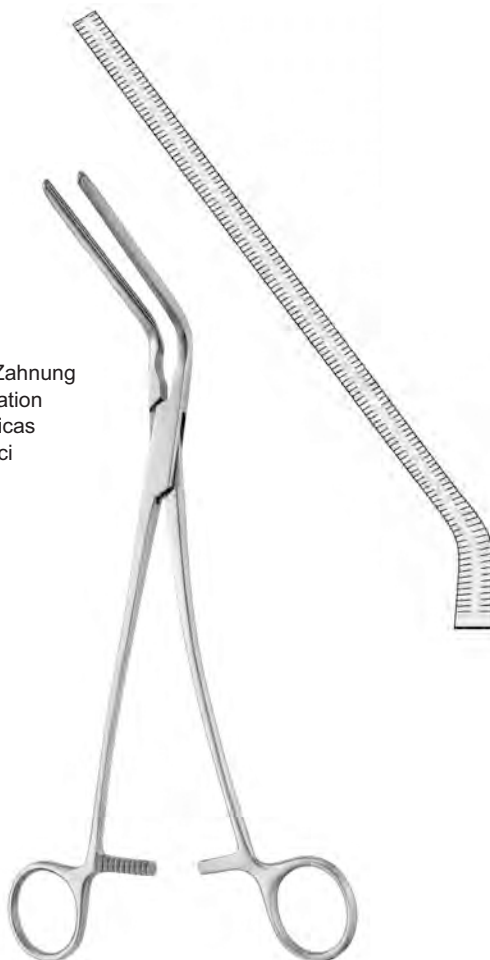


BRUNNER
 24,0 cm, 9¹/₂"
160-240-24

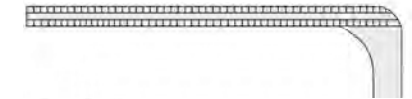


BRUNNER
 24,0 cm, 9¹/₂"
164-240-24

mit atraumatischer Zahnung
 with atraumatic serration
 con bacos atraumáticas
 con morsi atraumatici



GLASSMAN
 23,0 cm, 9"
160-259-23



GLASSMAN
 23,5 cm, 9¹/₄"
160-253-23



Mauflänge
 length of jaws
 longitud de la boca
 bocche lungh

5,0 cm, 2"	160-320-05
7,0 cm, 2 1/2"	160-320-07
10,0 cm, 4"	160-320-10

DE MARTEL-WOLFSON



DE MARTEL-WOLFSON
 8,5 cm, 3 1/2"
160-340-08



DE MARTEL-WOLFSON
 26,0 cm, 10 1/4"
160-325-26



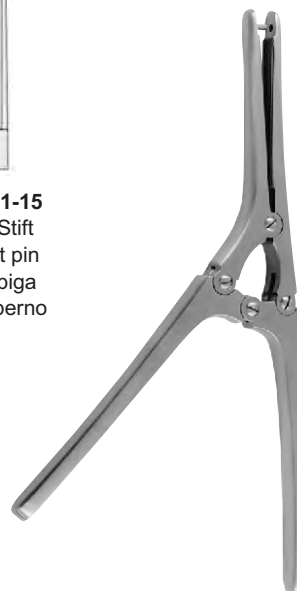
160-310-15
 mit Stift
 with pin
 con espiga
 con perno



160-311-15
 ohne Stift
 without pin
 sin espiga
 senza perno



BABY-PAYR
 15,0 cm, 6"



PAYR



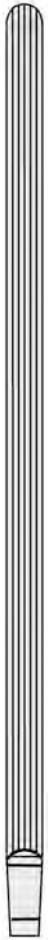
21,0 cm, 8 1/4" **160-310-21**



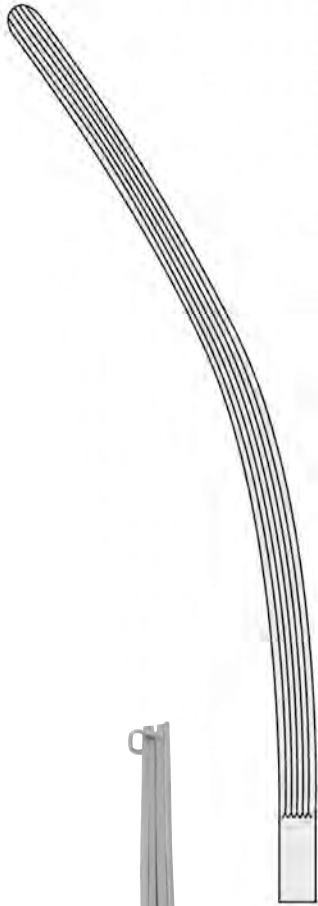
160-311-21
 29,0 cm, 11 1/2" **160-310-29** **160-311-29**

mit Stift with pin con espiga con perno	ohne Stift without pin sin espiga senza perno
--	--

Darm- und Magenklappen
 Intestinal and Stomach Clamp Forceps
 Pinzas-clamps intestinales y estomacales
 Pinze per intestino e stomaco



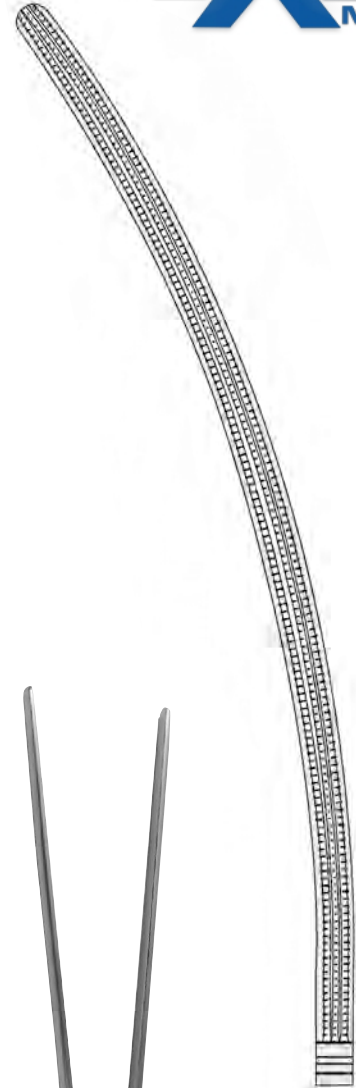
160-360-30



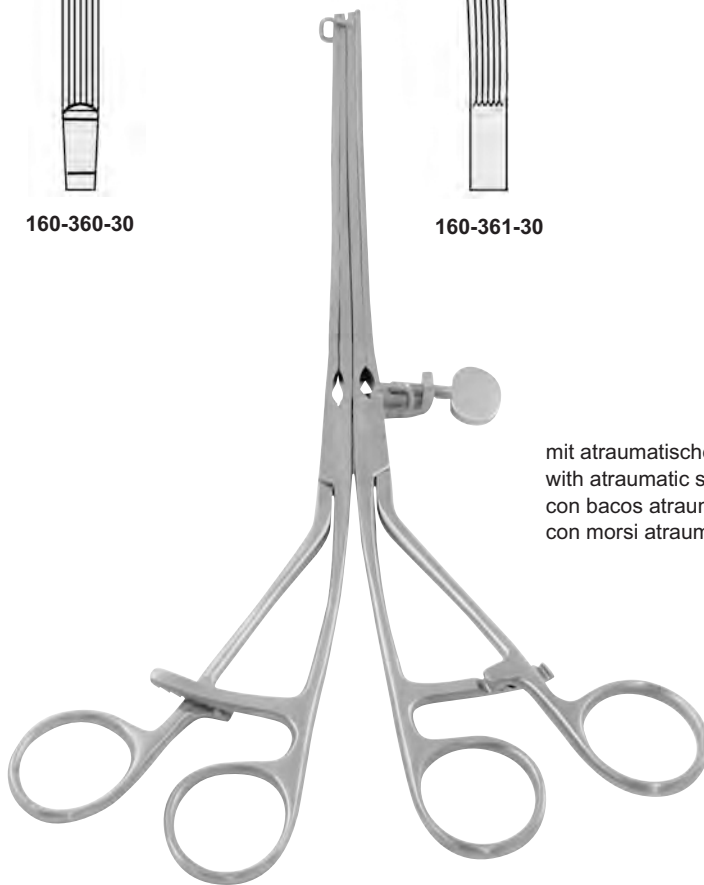
160-361-30



160-364-33

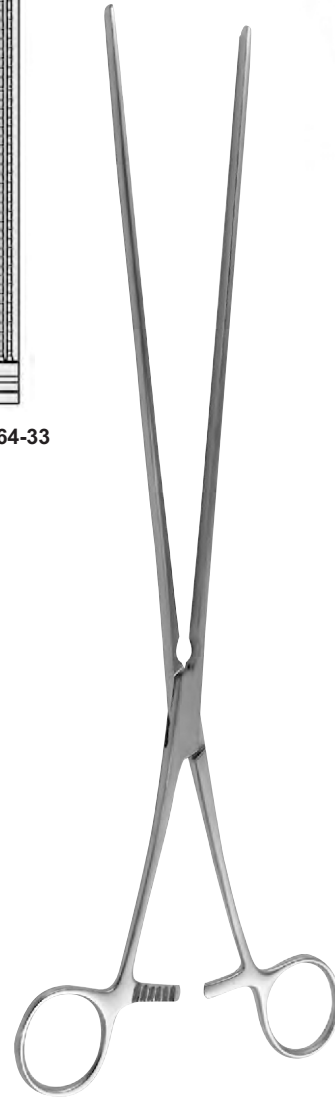


160-365-33



LANE
 30,0 cm, 11³/₄"

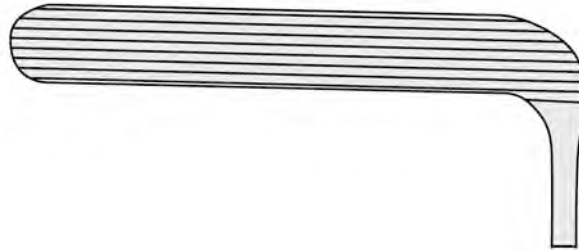
mit atraumatischer Zahnung
 with atraumatic serration
 con bacos atraumáticas
 con morsi atraumatici



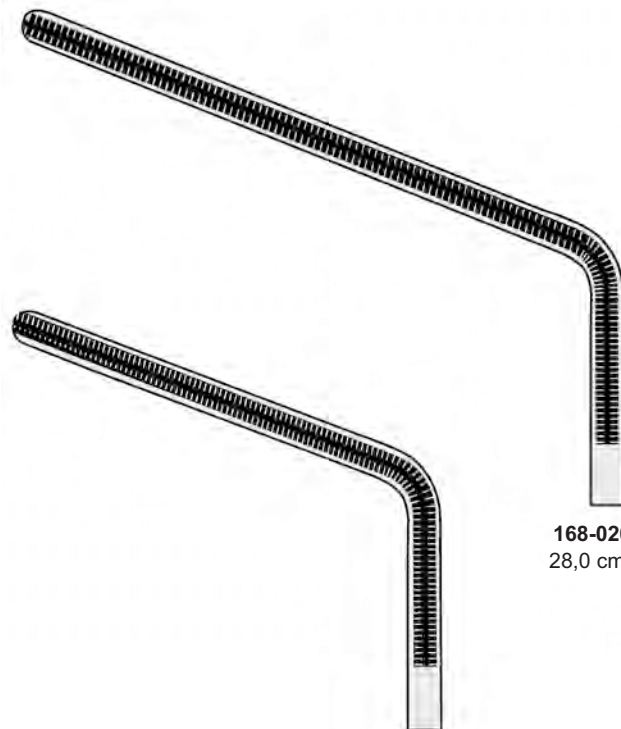
SCUDDER
 33,0 cm, 13"



MIKULICZ
19,0 cm, 7 1/2"
168-010-19



HAYES



168-020-28
28,0 cm, 11"

168-020-26
26,0 cm, 10"

Mastdarm-Rektum-Spekula
Rectal Specula
Espéculos para el recto
Speculi rettali



17 x 89 mm



SIMS
15,0 cm, 6"
168-108-15

17 x 89 mm



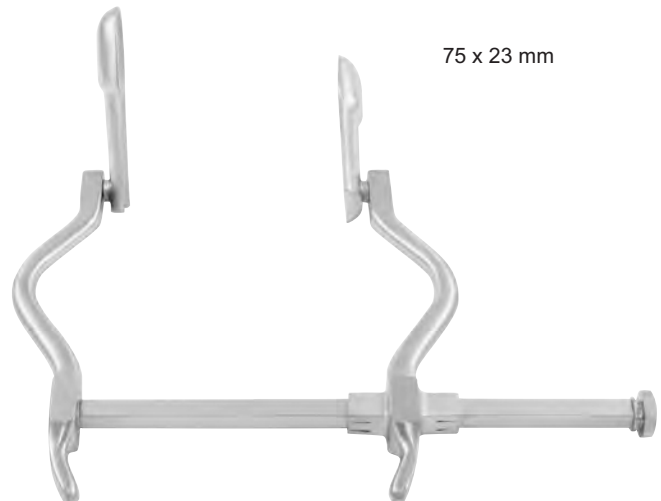
SIMS
15,0 cm, 6"
168-110-15

25 x 89 mm

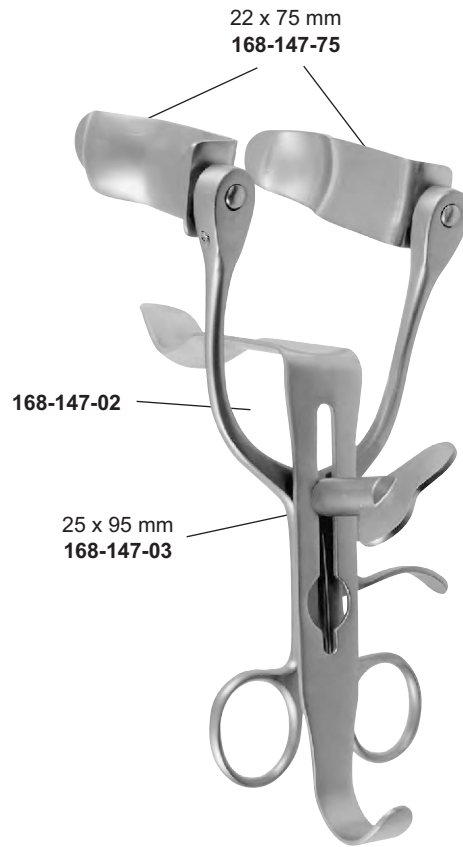


MATHIEU
21,0 cm, 8 1/4"
168-150-21

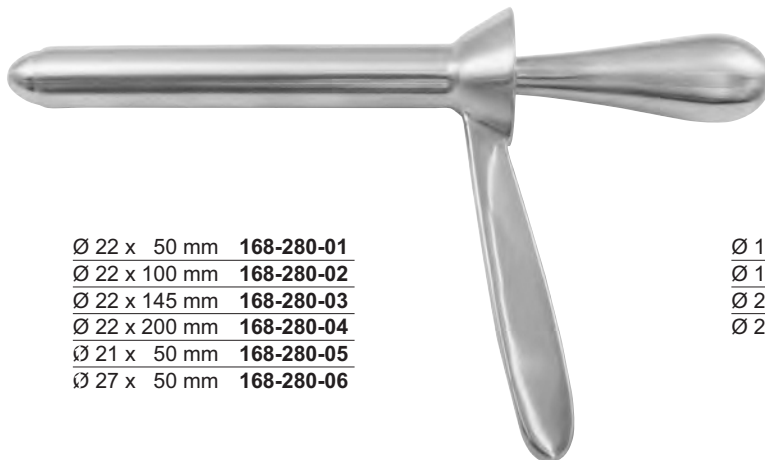
75 x 23 mm



SMITH-BUIE
15,0 cm, 6"
168-160-15

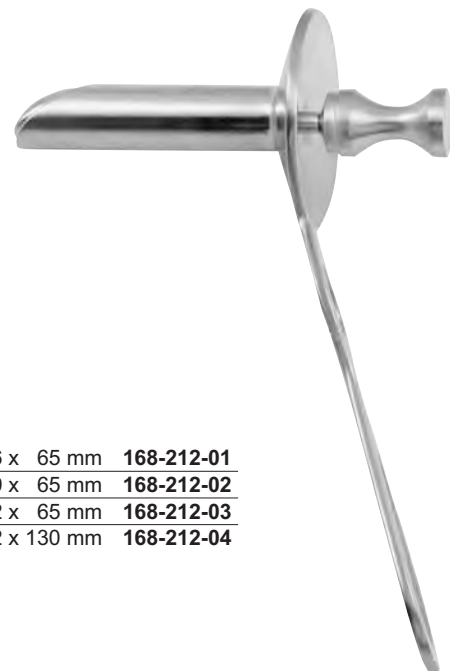


ALAN PARKS
13,5 cm, 5³/₈"
168-147-00



Ø 22 x 50 mm **168-280-01**
Ø 22 x 100 mm **168-280-02**
Ø 22 x 145 mm **168-280-03**
Ø 22 x 200 mm **168-280-04**
Ø 21 x 50 mm **168-280-05**
Ø 27 x 50 mm **168-280-06**

HAYES



Ø 16 x 65 mm **168-212-01**
Ø 19 x 65 mm **168-212-02**
Ø 22 x 65 mm **168-212-03**
Ø 22 x 130 mm **168-212-04**

HIRSCHMANN



Ø 22 x 65 mm **168-250-22**
Ø 30 x 65 mm **168-250-30**

CHELSEA EATON

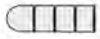


ohne Kaltlichtträger
without cold light carrier
sin portador para luz fría
senza luce fredda

IVES FANSLER
Ø 22 mm
168-268-01

mit Kaltlichtträger
with cold light carrier
con portador para luz fría
con luce fredda

IVES FANSLER
Ø 22 mm
168-268-02



28,0 cm, 11" **168-300-28**
 35,0 cm, 13³/₄" **168-300-35**
 42,0 cm, 16¹/₂" **168-300-42**



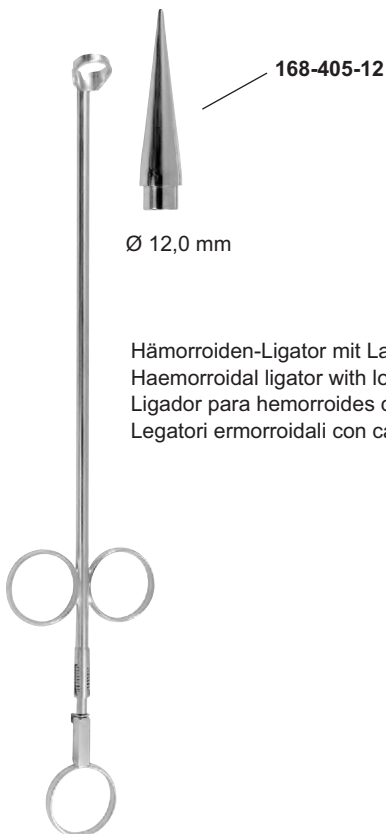
28,0 cm, 11" **168-311-28**
 35,0 cm, 13³/₄" **168-311-35**
 42,0 cm, 16¹/₂" **168-311-42**



28,0 cm, 11" **168-301-28**
 35,0 cm, 13³/₄" **168-301-35**
 42,0 cm, 16¹/₂" **168-301-42**



28,0 cm, 11" **168-312-28**
 35,0 cm, 13³/₄" **168-312-35**
 42,0 cm, 16¹/₂" **168-312-42**



Hämorrhoiden-Ligator mit Ladekonus
 Haemorrhoidal ligator with loading attachment
 Ligador para hemorroides con cono de carga
 Legatori emorroidali con carica a cono

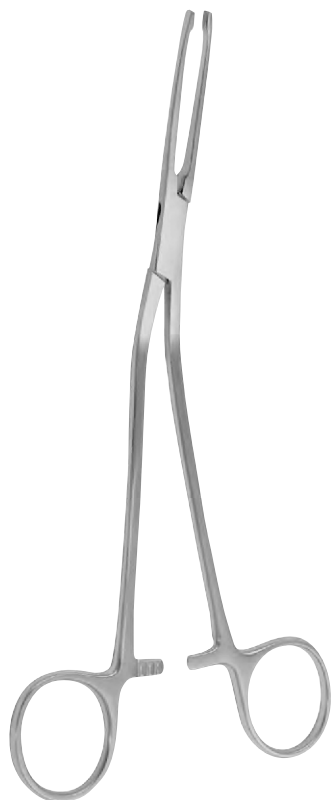
RUDD
 168-400-00



Hämorrhoiden-Ligator mit Ladekonus
 Haemorrhoidal ligator with loading attachment
 Ligador para hemorroides con cono de carga
 Legatori emorroidali con carica a cono

MC GIVNEY
 168-410-00

Hämorrhoiden-Faßzangen, Fistelsonden
Haemorrhoidal Forceps, Fistula probes
Pinza-clamps para hemorroides, Sondas para fistula
Pinze per emorroidi, Sonde per fistola



MC GIVNEY
19,0 cm, 7 1/2"
168-471-19



MC GIVNEY
19,0 cm, 7 1/2"
168-473-19



PRATT
21,0 cm, 8 1/4"



080-135-01



080-135-02



080-135-03

für Jungfrauen
 for virgins
 para vírgenes
 per vergini

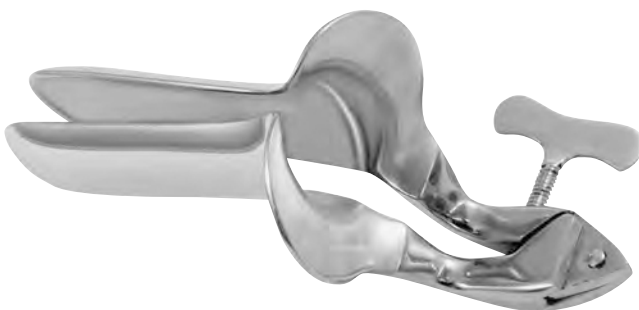


COLLIN
 65 x 10 mm
 180-132-00

für Kinder
 for children
 para niños
 per bambini



COLLIN
 65 x 10 mm
 180-134-00



COLLIN

85 x 30 mm	180-130-01
100 x 35 mm	180-130-02
110 x 40 mm	180-130-03



80 x 24 mm	180-142-01
80 x 32 mm	180-142-02
98 x 16 mm	180-142-03
105 x 25 mm	180-142-04
107 x 29 mm	180-142-05
115 x 35 mm	180-142-06

zentrale Stellschraube
central fixation screw
tornillo de sujeto central
vite di regolazione centrale



CUSCO

75 x 32 mm	180-144-01
85 x 36 mm	180-144-02
95 x 37 mm	180-144-03

seitliche Stellschraube
lateral fixation screw
tornillo de sujeto lateral
vite di regolazione laterale



für Jungfrauen
for virgins
para virgenes
per vergini

CUSCO

75 x 17 mm
180-140-00

seitliche Stellschraube
lateral fixation screw
tornillo de sujeto lateral
vite di regolazione laterale



CUSCO

75 x 32 mm	180-140-01
85 x 35 mm	180-140-02
100 x 35 mm	180-140-03

Schweizer Modell
Swiss pattern
Modelo suizo
Modello svizzero



CUSCO

90 x 23-25 mm	180-146-01
100 x 25-27 mm	180-146-02
110 x 27-30 mm	180-146-03



GRAVE

75 x 20 mm	180-100-01
95 x 35 mm	180-100-02
115 x 35 mm	180-100-03



PEDERSON

75 x 13 mm	180-120-01
100 x 22 mm	180-120-02
120 x 25 mm	180-120-03



SEMM

90 x 14-18 mm	180-150-01
100 x 17-20 mm	180-150-02
100 x 25-30 mm	180-150-03



WEISSBARTH
 21,0 cm, 8 1/4"
180-160-00



mit abnehmbarem Gewicht
with detachable weight
con peso desmontable
con peso smontabile

1,14 kg

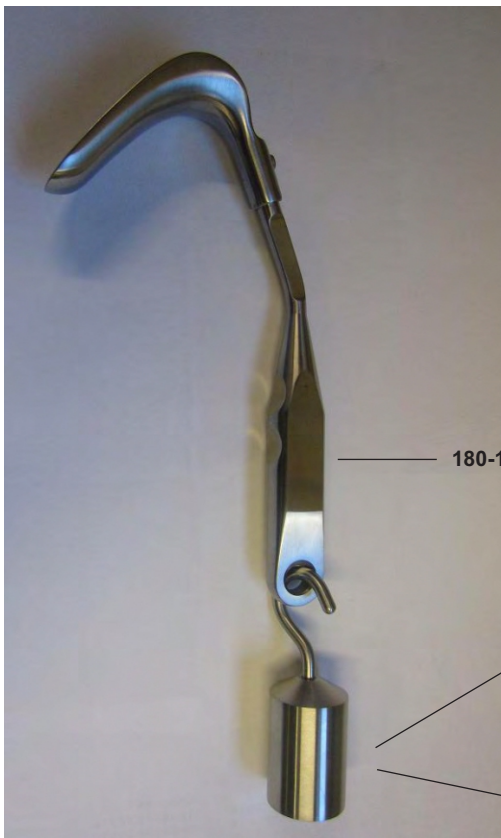
AUVARD
75 x 38 mm
180-170-00



mit festem Gewicht
with fixed weight
con peso fijo
con peso fisso

1,14 kg

AUVARD
75 x 38 mm
180-172-00



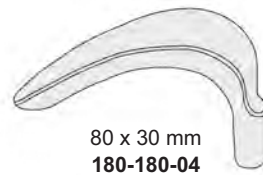
180-180-03

400 g
180-180-40

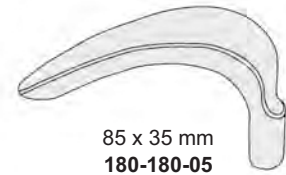
800 g
180-180-80

SCHERBACK
180-180-00

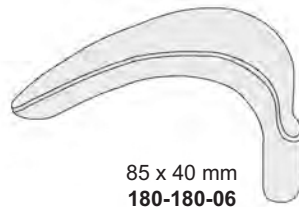
koplett, complete, completo, completo



80 x 30 mm
180-180-04



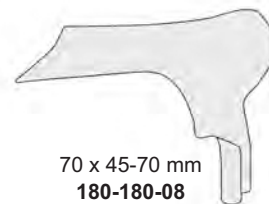
85 x 35 mm
180-180-05



85 x 40 mm
180-180-06



55 x 40-60 mm
180-180-07



70 x 45-70 mm
180-180-08



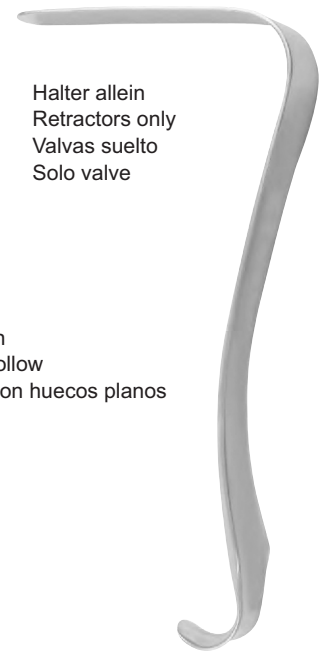
Satz
 Set
 Juego
 Set

KRISTELLER
 Fig. 1 **180-220-01**
 Fig. 2 **180-220-02**
 Fig. 3 **180-220-03**



Spekula allein, flach
 Specula only, flat hollow
 Espéculos suelto, con huecos planos
 Solo speculi, piatta

KRISTELLER
 105 x 26 mm **180-221-01**
 105 x 28 mm **180-221-02**
 105 x 33 mm **180-221-03**



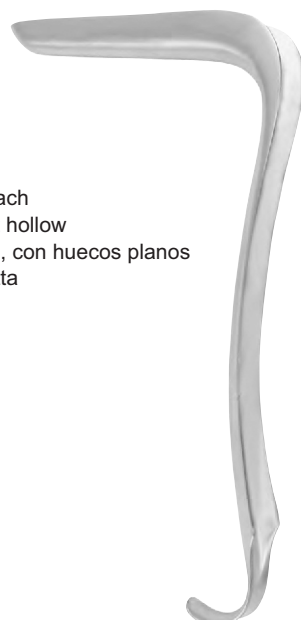
Halter allein
 Retractors only
 Valvas suelto
 Solo valve

KRISTELLER
 115 x 22 mm **180-222-01**
 115 x 24 mm **180-222-02**
 115 x 29 mm **180-222-03**



Satz
 Set
 Juego
 Set

KRISTELLER
 Fig. 1 **180-230-01**
 Fig. 2 **180-230-02**
 Fig. 3 **180-230-03**



Spekula allein, flach
 Specula only, flat hollow
 Espéculos suelto, con huecos planos
 Solo speculi, piatta

KRISTELLER
 110 x 27 mm **180-231-01**
 110 x 30 mm **180-231-02**
 110 x 36 mm **180-231-03**



Halter allein
 Retractors only
 Valvas suelto
 Solo valve

KRISTELLER
 115 x 23 mm **180-232-01**
 115 x 26 mm **180-232-02**
 115 x 32 mm **180-232-03**



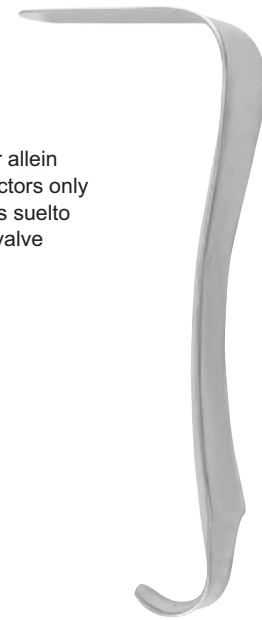
Satz
Set
Juego
Set

KRISTELLER
Fig. 0 **180-234-00**
Fig. 1 **180-234-01**
Fig. 2 **180-234-02**
Fig. 3 **180-234-03**



Spekula allein
Specula only
Espéculos suelto
Solo speculi

KRISTELLER
70 x 15 mm **180-235-00**
70 x 27 mm **180-235-01**
80 x 30 mm **180-235-02**
90 x 36 mm **180-235-03**



Halter allein
Retractors only
Valvas suelto
Solo valve

KRISTELLER
75 x 10 mm **180-236-00**
75 x 23 mm **180-236-01**
85 x 26 mm **180-236-02**
100 x 32 mm **180-236-03**



konisch, für Jungfrauen
conical blades, for virgins
valvas cónicos, para vírgenes
valve coniche, per vergini

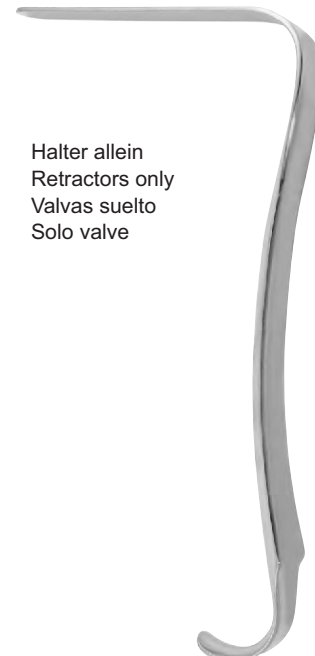
KRISTELLER
Fig. 00 **180-237-01**
Fig. 0 **180-237-02**



Spekula allein
Specula only
Espéculos suelto
Solo speculi

Satz
Set
Juego
Set

KRISTELLER
105 x 18 mm **180-238-01**
105 x 21 mm **180-238-02**



Halter allein
Retractors only
Valvas suelto
Solo valve

KRISTELLER
110 x 14 mm **180-239-01**
110 x 17 mm **180-239-02**



leicht hohl
 slightly-concave
 ligeremente concavos
 leggeremente concavi

Fig	a x b	
1	55 x 35 mm	180-260-01
2	85 x 35 mm	180-260-02
3	115 x 35 mm	180-260-03

1	55 x 45 mm	180-261-01
2	85 x 45 mm	180-261-02
3	115 x 45 mm	180-261-03
4	160 x 45 mm	180-261-04

1	55 x 60 mm	180-262-01
2	85 x 60 mm	180-262-02
3	115 x 60 mm	180-262-03
4	160 x 60 mm	180-262-04

DOYEN
 23,0 cm, 9"



halb-hohl
 medium-concave
 semi-concavos
 semi-concavi

Fig	a x b	
1	55 x 35 mm	180-264-01
2	85 x 35 mm	180-264-02
3	115 x 35 mm	180-264-03

1	55 x 45 mm	180-265-01
2	85 x 45 mm	180-265-02
3	115 x 45 mm	180-265-03

1	55 x 60 mm	180-266-01
2	85 x 60 mm	180-266-02
3	115 x 60 mm	180-266-03

DOYEN
 23,0 cm, 9"



Satz
Set
Juego
Set

KALLMORGEN

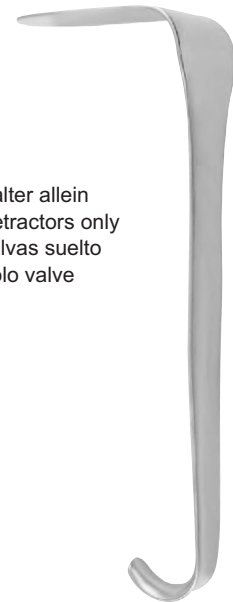
70 x 40 mm	180-270-01
90 x 40 mm	180-270-02



Spekula allein
Specula only
Especulos suelto
Solo speculi

KALLMORGEN

70 x 40 mm	180-271-01
90 x 40 mm	180-271-02



Halter allein
Retractors only
Valvas suelto
Solo valve

KALLMORGEN

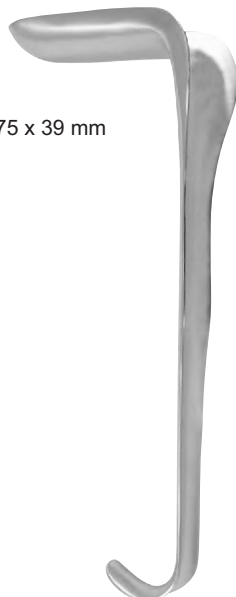
70 x 40 mm	180-272-01
90 x 40 mm	180-272-02



70 x 15 mm

KRISTELLER

17,0 cm, 6³/₄"
180-275-17



75 x 39 mm

KALLMORGEN

17,0 cm, 6³/₄"
180-290-17



JACKSON

75 x 38 mm	180-290-01
90 x 38 mm	180-290-02
100 x 38 mm	180-290-03

76 x 25 mm



70 x 22 mm

BREISKY
14,0 cm, 5½"
180-292-01

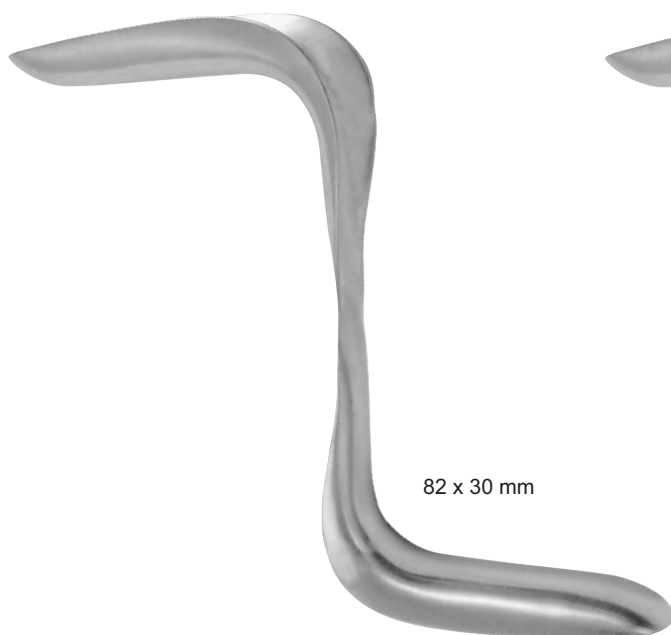
82 x 30 mm



76 x 25 mm

BREISKY
14,0 cm, 5½"
180-292-02

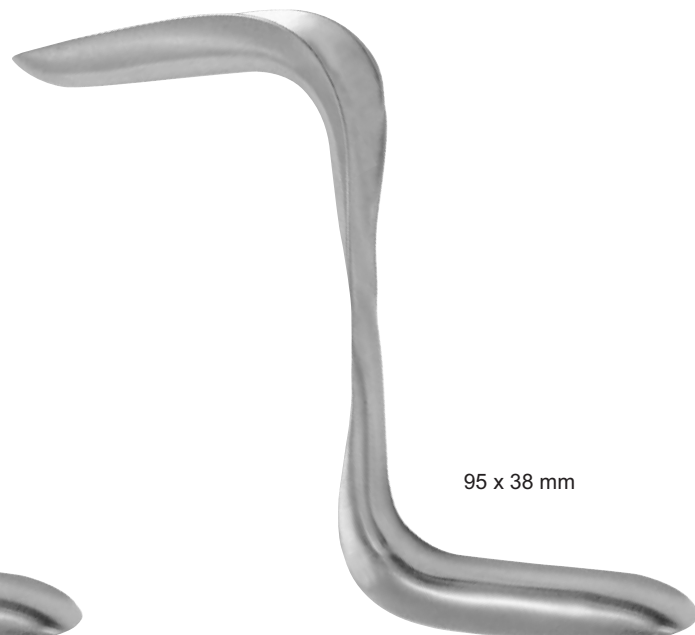
95 x 38 mm



82 x 30 mm

BREISKY
17,0 cm, 6¾"
180-292-03

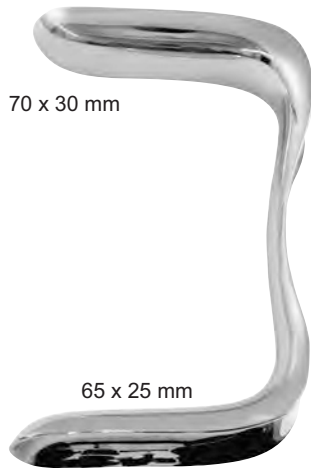
102 x 44 mm



95 x 38 mm

BREISKY
17,0 cm, 6¾"
180-292-04

SIMS
57-8294-00
Satz, Set, Juego, Set, набор



70 x 30 mm

65 x 25 mm

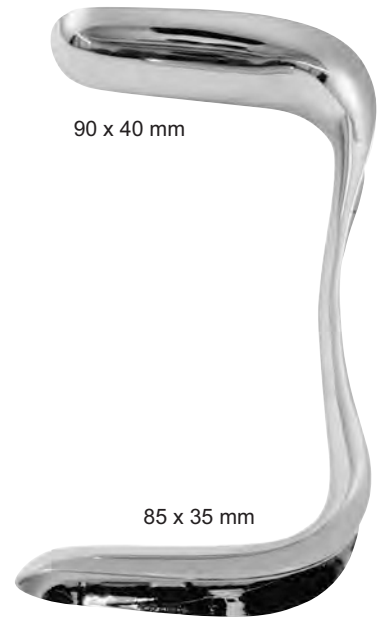
SIMS
12,5 cm, 5"
180-294-01



70 x 35 mm

70 x 30 mm

SIMS
15,0 cm, 6"
180-294-02



90 x 40 mm

85 x 35 mm

SIMS
17,5 cm, 7"
180-294-03



Spekula allein
Specula only
Espéculos sueltos
Solo speculi

MATHIEU
100 x 13-23 mm **180-300-01**
100 x 16-30 mm **180-300-02**



Halter allein
Retractors only
Valvas sueltos
Solo valve

MATHIEU
100 x 11-21 mm **180-301-01**
100 x 14-27 mm **180-301-02**



LANDAU
100 x 28 mm **180-305-01**
100 x 38 mm **180-305-02**

Scheidenspekula
 Vaginal Specula
 Espéculos vaginales
 Speculi vaginali



100 x 20 mm	180-307-20
100 x 25 mm	180-307-25
100 x 30 mm	180-307-30
100 x 35 mm	180-307-35
100 x 40 mm	180-307-40
<hr/>	
130 x 20 mm	180-308-20
130 x 25 mm	180-308-25
130 x 30 mm	180-308-30
130 x 35 mm	180-308-35
130 x 40 mm	180-308-40
<hr/>	
155 x 40 mm	180-309-40

BREISKY



85 x 17 mm

BRAUN, MODIF.
 19,0 cm, 7 1/2"
180-313-19



60 x 30 mm

DOYEN
 23,0 cm, 9"
180-315-23



80 x 30 mm

DOYEN
 25,0 cm, 9"
180-315-25



95 x 38 mm

WERTHEIM
 30,0 cm, 12"
180-317-30



KOGAN
24,0 cm, 9 1/2"



3,0 mm

180-092-03



4,0 mm

180-092-04



5,0 mm

180-092-05



KOGAN
24,0 cm, 9 1/2"



3,0 mm

180-090-03



4,0 mm

180-090-04



5,0 mm

180-090-05

Uterus-Dilatatoren
 Uterine Dilators
 Dilataores uterinos
 Dilatatori uterini



Ø 1,0 mm	180-350-01
Ø 2,0 mm	180-350-02
Ø 3,0 mm	180-350-03
Ø 4,0 mm	180-350-04
Ø 5,0 mm	180-350-05
Ø 6,0 mm	180-350-06
Ø 7,0 mm	180-350-07
Ø 8,0 mm	180-350-08
Ø 9,0 mm	180-350-09
Ø 10,0 mm	180-350-10
Ø 11,0 mm	180-350-11
Ø 12,0 mm	180-350-12
Ø 13,0 mm	180-350-13
Ø 14,0 mm	180-350-14
Ø 15,0 mm	180-350-15
Ø 16,0 mm	180-350-16
Ø 17,0 mm	180-350-17
Ø 18,0 mm	180-350-18
Ø 19,0 mm	180-350-19
Ø 20,0 mm	180-350-20
Ø 21,0 mm	180-350-21
Ø 22,0 mm	180-350-22
Ø 23,0 mm	180-350-23
Ø 24,0 mm	180-350-24
Ø 25,0 mm	180-350-25
Ø 26,0 mm	180-350-26

HEGAR
 18,5 cm, 7¼"



Ø 1,5 mm	180-351-01
Ø 2,5 mm	180-351-02
Ø 3,5 mm	180-351-03
Ø 4,5 mm	180-351-04
Ø 5,5 mm	180-351-05
Ø 6,5 mm	180-351-06
Ø 7,5 mm	180-351-07
Ø 8,5 mm	180-351-08
Ø 9,5 mm	180-351-09
Ø 10,5 mm	180-351-10
Ø 11,5 mm	180-351-11
Ø 12,5 mm	180-351-12
Ø 13,5 mm	180-351-13
Ø 14,5 mm	180-351-14
Ø 15,5 mm	180-351-15
Ø 16,5 mm	180-351-16
Ø 17,5 mm	180-351-17

HEGAR
 18,5 cm, 7¼"



205 x 105 x 45 mm

HEGAR
180-350-99
 Satz, Set, Juego, Set
 Ø 1,0 - Ø 26,0
 (26 dilators)

HEGAR
180-350-98
 Satz, Set, Juego, Set
 Ø 4,0 - Ø 17,0
 (14 dilators)



HEGAR
20,0 cm, 8"

Ø 1,0 / 2,0 mm	180-354-01
Ø 0 / 4,0 mm	180-354-03
Ø 0 / 6,0 mm	180-354-05
Ø 0 / 8,0 mm	180-354-07
Ø 9,0 / 10,0 mm	180-354-09
Ø 11,0 / 12,0 mm	180-354-11
Ø 13,0 / 14,0 mm	180-354-13
Ø 15,0 / 16,0 mm	180-354-15
Ø 17,0 / 18,0 mm	180-354-17
Ø 19,0 / 20,0 mm	180-354-19
Ø 21,0 / 22,0 mm	180-354-21
Ø 23,0 / 24,0 mm	180-354-23
Ø 25,0 / 26,0 mm	180-354-25



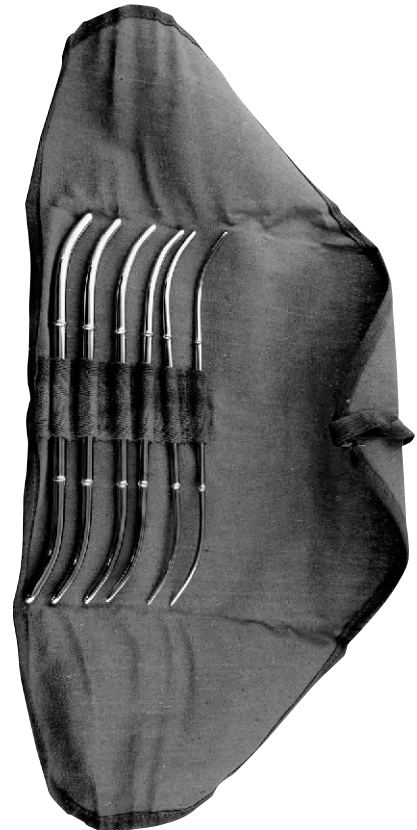
HEGAR
180-354-98
Satz, Set, Juego, Set
Ø 3,0 / 4,0 - Ø 17,0 / 18,0 mm
(8 dilators)

HEGAR
180-354-99
Satz, Set, Juego, Set
Ø 1,0 / 2,0 - Ø 25,0 / 26,0 mm
(13 dilators)



HANK

Ø 4,5 / 5,0 mm	180-360-05
Ø 5,5 / 6,0 mm	180-360-06
Ø 6,5 / 7,0 mm	180-360-07
Ø 7,5 / 8,0 mm	180-360-08
Ø 8,5 / 9,0 mm	180-360-09
Ø 9,5 / 10,0 mm	180-360-10



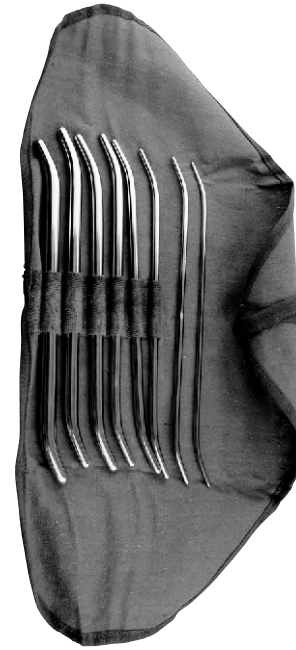
HANK
180-360-98
Satz, Set, Juego, Set
Ø 4,5 / 5,0 - Ø 9,5 / 10,0 mm
(6 dilators)

Uterus-Dilatatoren, Hakenzangen
 Uterine Dilators, Uterine Tenaculum Forceps
 Dilataores uterinos, Pinzas para coger el cuello del útero
 Dilatatori uterini, Pinze per abbassare il collo del'utero



PRATT

Ø5 /	5,0 mm	180-370-05
Ø5 /	6,0 mm	180-370-06
Ø5 /	8,0 mm	180-370-08
Ø5 /	9,0 mm	180-370-09
Ø	9,5 / 10,0 mm	180-370-10
Ø	11,5 / 12,0 mm	180-370-12
Ø	12,5 / 13,0 mm	180-370-13
Ø	13,5 / 14,0 mm	180-370-14



PRATT
180-370-98
 Satz, Set, Juego, Set
 Ø 4,5 / 5,0 - Ø 13,5 / 14,0 mm
 (8 dilators)



BARRETT
 18,0 cm, 7"
180-410-18



ADAIR
 19,0 cm, 7½"
180-412-19



STAUDE-MOORE
 17,0 cm, 6¾"
180-414-17



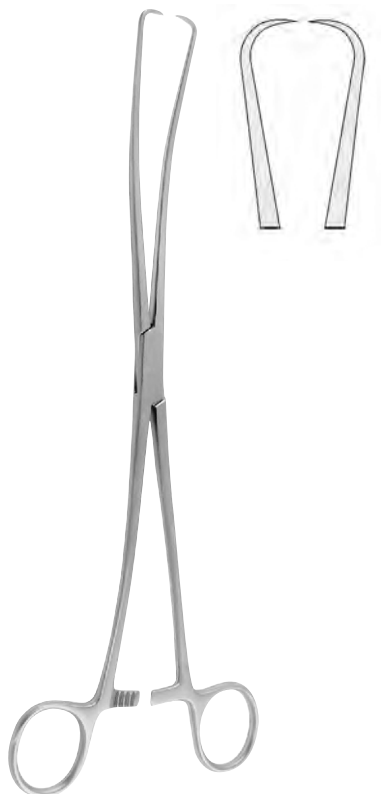
JARCHO
20,0 cm, 8"
180-417-20



SCHROEDER
25,0 cm, 9³/₄"
180-400-25



BRAUN
25,0 cm, 9³/₄"
180-404-25



DUPLAY
28,0 cm, 11"
180-419-28

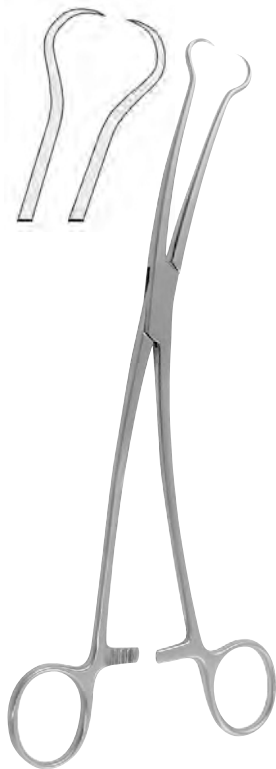


POZZI
26,0 cm, 10¹/₄"
180-402-26



KAHN
24,0 cm, 9¹/₂"
180-421-24

Hakenzangen
 Uterine Tenaculum Forceps
 Pinzas para coger el cuello del útero
 Pinze per abbassare il collo dell'utero



SKENE
 24,0 cm, 9 1/2"
 180-423-24



SCHROEDER
 24,0 cm, 9 1/2"
 180-426-24



SCHROEDER
 24,0 cm, 9 1/2"
 180-429-24



TEALE
 23,0 cm, 9"
 180-431-23



JACOBS
 21,0 cm, 8 1/2"
 180-434-21



JACOBS
 21,0 cm, 8 1/2"
 180-435-21



MUSEUX
24,0 cm, 9 1/2"



MUSEUX
24,0 cm, 9 1/2"



BRAUN
15,5 cm, 6"
180-442-15



CZERNY
20,5 cm, 8"
180-444-20



PRATT
28,0 cm, 11"
180-446-28



IOWA
26,0 cm, 10 1/4"
180-449-26

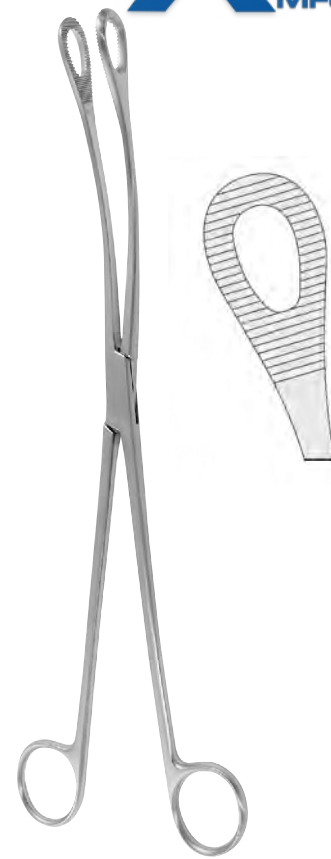
Polypen- und Ovarienzangen, Uterusfaßzangen
 Polypus and Ovum Forceps, Uterine Elevating Forceps
 Pinzas para pólipos uterinos y ovarios, Pinzas para la útero
 Pinze per polipi e ovaie, Pinze per affarrare l'utero



DOYEN
 20,5 cm, 8"
 180-470-20



NOTO
 27,0 cm, 10⁵/₈"
 180-472-27



KELLY
 32,0 cm, 12¹/₂"
 180-475-32



HEYWOOD-SMITH
 25,0 cm, 9³/₄"
 180-480-25



DARTIGUES
 27,0 cm, 10³/₄"
 180-482-27



SOMER
 23,0 cm, 9"
 180-485-23



COLLIN
 25,0 cm, 9³/₄"
 180-488-25



BEACHAM
 26,0 cm, 10¹/₄"
 180-500-26

Amniotom
 Amniotome
 Amniótomo
 Amniotomo



BRAUN
 28,0 cm, 11"
 180-502-28

Uterus-Depressor
 Uterine depressor
 Depresor uterino
 Depressori uterini



SIMS
 32,0 cm, 12¹/₂"
 180-510-32



SIMS
 32,0 cm, 12¹/₂"
 180-511-32

biegsam
 malleable
 maleable
 malleabile



MARTIN
 32,0 cm, 12¹/₂"
 180-516-32



MARTIN
 32,0 cm, 12¹/₂"
 180-518-32

biegsam
 malleable
 maleable
 malleabile



VALLEIX
 25,0 cm, 10"
 180-521-25



SIMPSON
 29,0 cm, 11¹/₂"
 180-527-29

Ø 4 mm

biegsam
 malleable
 maleable
 malleabile

Ø 4 mm

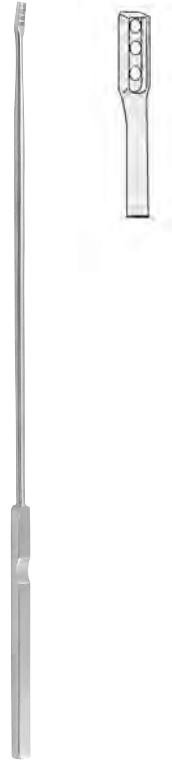


COLLIN
 28,0 cm, 11"
 180-529-28

Biopsieküretten
 Biopsy Currettes
 Curetas para biopsia
 Curette per biopsia



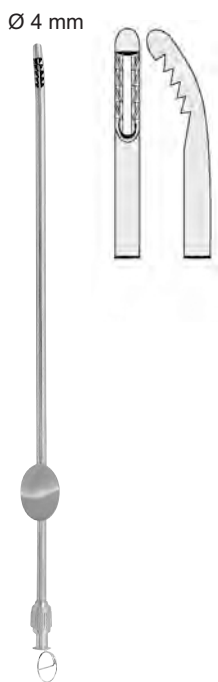
KEVORKIAN
 30,0 cm, 12"
 180-540-30



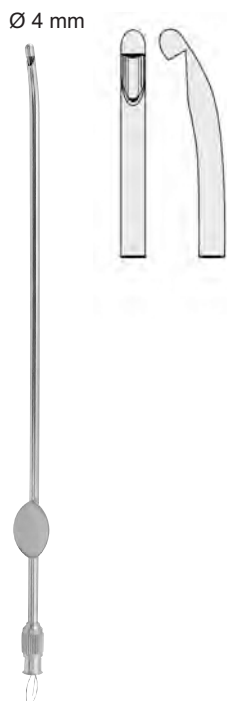
KEVORKIAN
 30,0 cm, 12"
 180-542-30



KEVORKIAN
 30,0 cm, 12"
 180-543-30



NOVAK
 23,0 cm, 9"
 180-550-04



RANDALL
 23,0 cm, 9"
 180-552-04



MILAN
 29,0 cm, 11½"

Ø 4 mm
 180-560-04

Ø 6 mm
 180-560-06

Ø 9 mm
 180-560-09



25,0 cm, 9³/₄"
180-570-25



25,0 cm, 9³/₄"
180-572-25



SIMON
22,0 cm, 8⁵/₈"
180-574-22



EMMETT
22,0 cm, 8⁵/₈"



180-576-01



180-576-02



180-576-03



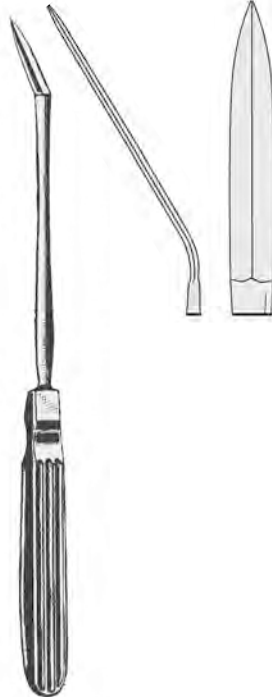
180-576-04



180-576-05



SEGOND
27,0 cm, 10⁵/₈"
180-580-27



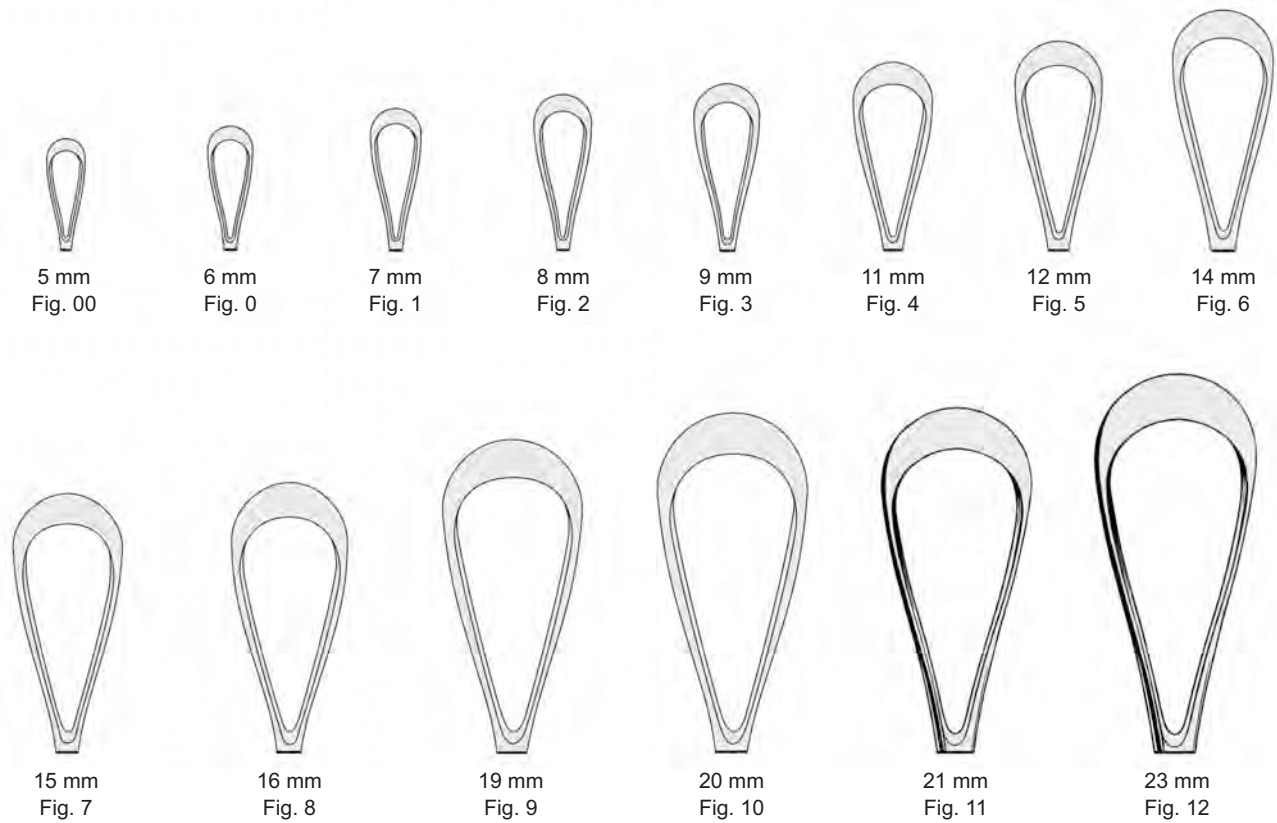
AYRE
23,0 cm, 9"
180-583-23



DOYEN
19,0 cm, 7¹/₂"
180-588-01



DOYEN
17,0 cm, 6³/₄"
180-588-02



scharf, fest
 sharp, rigid
 cortantes, rígidas
 acute, rigide

Fig. 00	180-700-05
Fig. 0	180-700-06
Fig. 1	180-700-07
Fig. 2	180-700-08
Fig. 3	180-700-09
Fig. 4	180-700-11
Fig. 5	180-700-12
Fig. 6	180-700-14
Fig. 7	180-700-15
Fig. 8	180-700-16
Fig. 9	180-700-19
Fig. 10	180-700-20
Fig. 11	180-700-21
Fig. 12	180-700-23

RECAMIER
 26,0 cm, 10¹/₄"



scharf, biegsam
 sharp, malleable
 cortantes, maleable
 acute, malleabile

Fig. 00	180-701-05
Fig. 0	180-701-06
Fig. 1	180-701-07
Fig. 2	180-701-08
Fig. 3	180-701-09
Fig. 4	180-701-11
Fig. 5	180-701-12
Fig. 6	180-701-14
Fig. 7	180-701-15
Fig. 8	180-701-16
Fig. 9	180-701-19
Fig. 10	180-701-20
Fig. 11	180-701-21
Fig. 12	180-701-23

RECAMIER
 26,0 cm, 10¹/₄"



5 mm
Fig. 00



6 mm
Fig. 0



7 mm
Fig. 1



8 mm
Fig. 2



9 mm
Fig. 3



11 mm
Fig. 4



12 mm
Fig. 5



14 mm
Fig. 6



15 mm
Fig. 7



16 mm
Fig. 8



19 mm
Fig. 9



20 mm
Fig. 10



21 mm
Fig. 11



23 mm
Fig. 12



scharf, fest
sharp, rigid
cortantes, rígidas
acute, rigide

Fig. 00	180-702-05
Fig. 0	180-702-06
Fig. 1	180-702-07
Fig. 2	180-702-08
Fig. 3	180-702-09
Fig. 4	180-702-11
Fig. 5	180-702-12
Fig. 6	180-702-14
Fig. 7	180-702-15
Fig. 8	180-702-16
Fig. 9	180-702-19
Fig. 10	180-702-20
Fig. 11	180-702-21
Fig. 12	180-702-23

SIMS

26,0 cm, 10 1/4"



scharf, biegsam
sharp, malleable
cortantes, maleable
acute, malleabile

Fig. 00	180-703-05
Fig. 0	180-703-06
Fig. 1	180-703-07
Fig. 2	180-703-08
Fig. 3	180-703-09
Fig. 4	180-703-11
Fig. 5	180-703-12
Fig. 6	180-703-14
Fig. 7	180-703-15
Fig. 8	180-703-16
Fig. 9	180-703-19
Fig. 10	180-703-20
Fig. 11	180-703-21
Fig. 12	180-703-23

SIMS

26,0 cm, 10 1/4"



5 mm
Fig. 00



6 mm
Fig. 0



7 mm
Fig. 1



8 mm
Fig. 2



9 mm
Fig. 3



11 mm
Fig. 4



12 mm
Fig. 5



14 mm
Fig. 6



15 mm
Fig. 7



16 mm
Fig. 8



19 mm
Fig. 9



20 mm
Fig. 10



21 mm
Fig. 11



23 mm
Fig. 12



scharf, fest
 sharp, rigid
 cortantes, rígidas
 acute, rigide

Fig. 00	180-710-05
Fig. 0	180-710-06
Fig. 1	180-710-07
Fig. 2	180-710-08
Fig. 3	180-710-09
Fig. 4	180-710-11
Fig. 5	180-710-12
Fig. 6	180-710-14
Fig. 7	180-710-15
Fig. 8	180-710-16
Fig. 9	180-710-19
Fig. 10	180-710-20
Fig. 11	180-710-21
Fig. 12	180-710-23

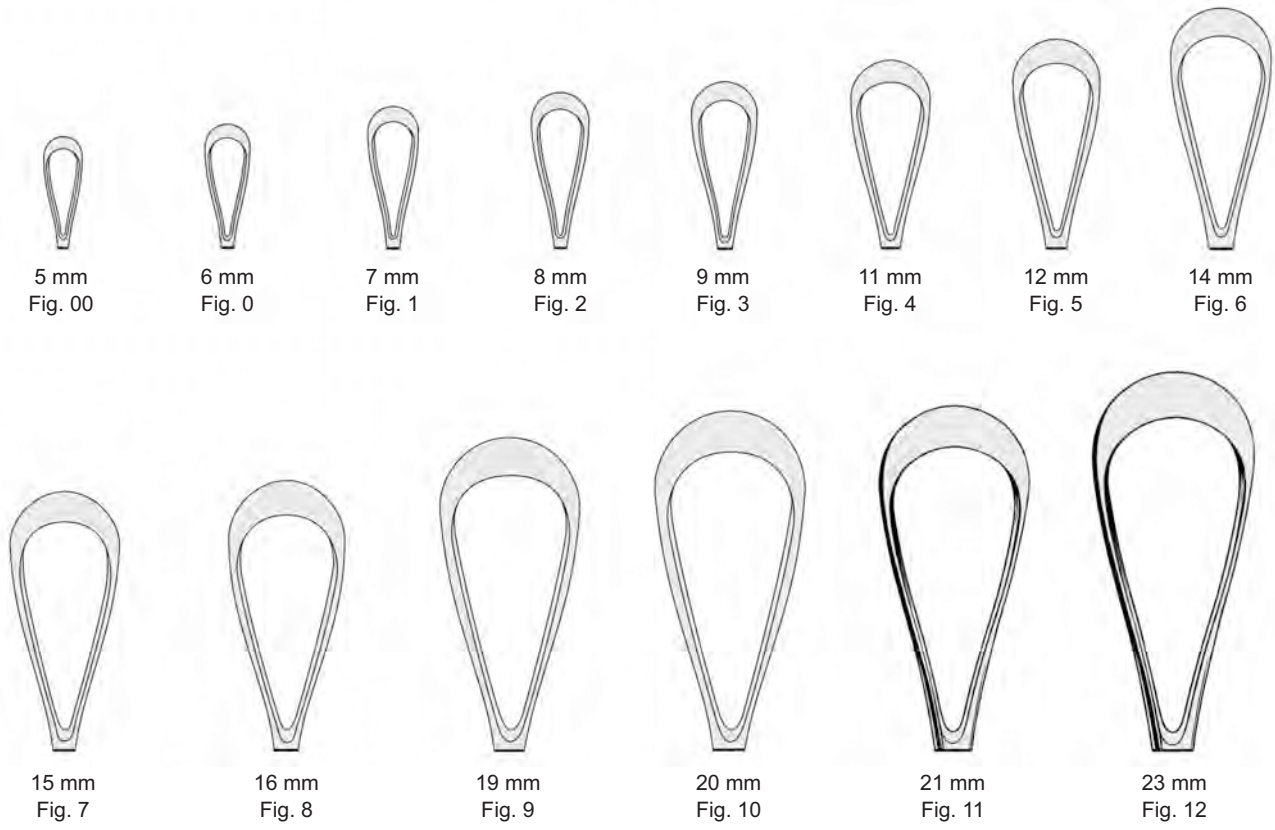
RECAMIER
 31,0 cm, 12¹/₄"



scharf, biegsam
 sharp, malleable
 cortantes, maleable
 acute, malleabile

Fig. 00	180-711-05
Fig. 0	180-711-06
Fig. 1	180-711-07
Fig. 2	180-711-08
Fig. 3	180-711-09
Fig. 4	180-711-11
Fig. 5	180-711-12
Fig. 6	180-711-14
Fig. 7	180-711-15
Fig. 8	180-711-16
Fig. 9	180-711-19
Fig. 10	180-711-20
Fig. 11	180-711-21
Fig. 12	180-711-23

RECAMIER
 31,0 cm, 12¹/₄"



scharf, fest
 sharp, rigid
 cortantes, rígidas
 acute, rigide

Fig. 00	180-712-05
Fig. 0	180-712-06
Fig. 1	180-712-07
Fig. 2	180-712-08
Fig. 3	180-712-09
Fig. 4	180-712-11
Fig. 5	180-712-12
Fig. 6	180-712-14
Fig. 7	180-712-15
Fig. 8	180-712-16
Fig. 9	180-712-19
Fig. 10	180-712-20
Fig. 11	180-712-21
Fig. 12	180-712-23

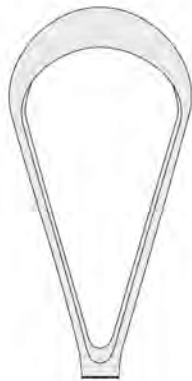
SIMS
 31,0 cm, 12 1/4"



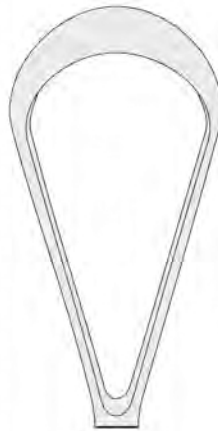
scharf, biegsam
 sharp, malleable
 cortantes, maleable
 acute, malleabile

Fig. 00	180-713-05
Fig. 0	180-713-06
Fig. 1	180-713-07
Fig. 2	180-713-08
Fig. 3	180-713-09
Fig. 4	180-713-11
Fig. 5	180-713-12
Fig. 6	180-713-14
Fig. 7	180-713-15
Fig. 8	180-713-16
Fig. 9	180-713-19
Fig. 10	180-713-20
Fig. 11	180-713-21
Fig. 12	180-713-23

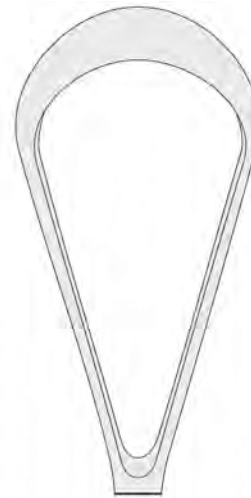
SIMS
 31,0 cm, 12 1/4"



30 mm
 Fig. 1



35 mm
 Fig. 2



40 mm
 Fig. 3



scharf, fest
 sharp, rigid
 cortantes, rígidas
 acute, rigide

Fig. 1 **180-720-30**
 Fig. 2 **180-720-35**
 Fig. 3 **180-720-40**

SIMS
 31,0 cm, 12¹/₄"



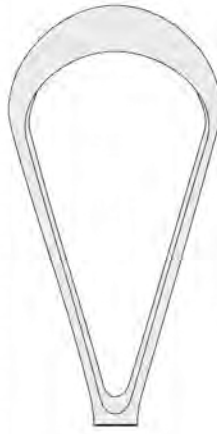
scharf, biegsam
 sharp, malleable
 cortantes, maleable
 acute, malleabile

Fig. 1 **180-721-30**
 Fig. 2 **180-721-35**
 Fig. 3 **180-721-40**

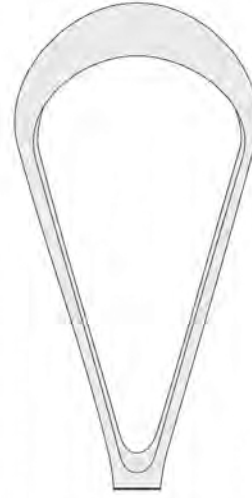
SIMS
 31,0 cm, 12¹/₄"



30 mm
Fig. 1



35 mm
Fig. 2



40 mm
Fig. 3



scharf, fest
sharp, rigid
cortantes, rígidas
acute, rigide

Fig. 1 **180-722-30**
Fig. 2 **180-722-35**
Fig. 3 **180-722-40**

BUMM
31,0 cm, 12¹/₄"



scharf, biegsam
sharp, malleable
cortantes, maleable
acute, malleabile

Fig. 1 **180-723-30**
Fig. 2 **180-723-35**
Fig. 3 **180-723-40**

BUMM
31,0 cm, 12¹/₄"

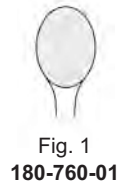
Uteruslöffel, Uterus-Biopsiezangen
 Uterine Scoopes, Cervical Biopsy and Specimen Forceps
 Cucharillas uterinas, Pinzas saca-bocados para biopsia
 Curette uterine, Pinze per la biopsia cervicale e da prelievo



BLAKE
 27,0 cm, 10⁵/₈"
 180-750-27



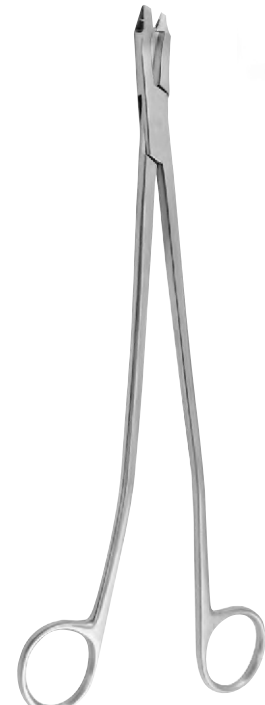
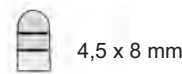
SIMON
 25,0 cm, 9³/₄"



THOMS-GAYLOR
 22,0 cm, 8⁵/₈" 180-680-22
 24,0 cm, 9¹/₂" 180-680-24



SCHUBERT
 21,0 cm, 8¹/₄" 180-682-21
 29,0 cm, 11¹/₂" 180-682-29



SCHUMACHER-VAN DOREN
 24,0 cm, 9¹/₂"
 180-684-24

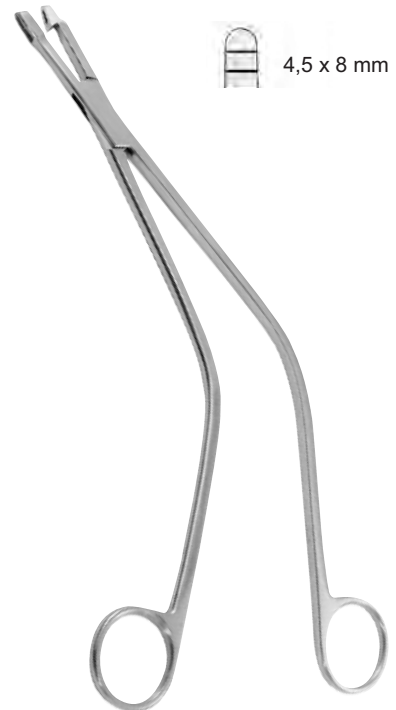




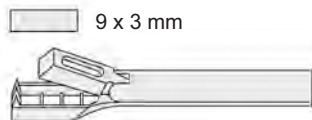
THOMS-GAYLOR
24,0 cm, 9 1/2"
180-686-24



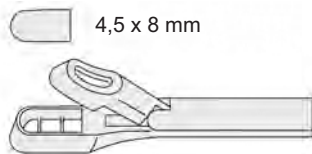
FAURE
21,0 cm, 8 1/4"
180-688-21



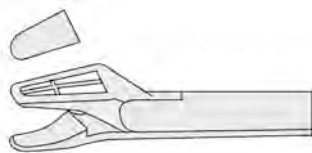
SCHUBERT
26,0 cm, 10 1/4"
180-690-26



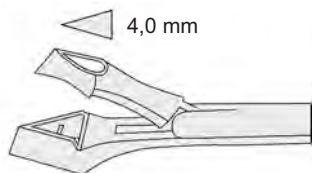
KEVORKIAN
25,0 cm, 10"
180-602-25



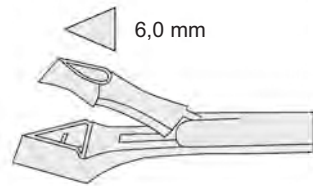
EPPENDORFER
20,0 cm, 8"
180-604-20



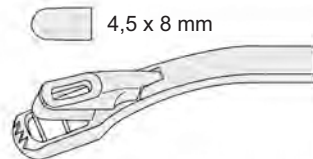
ALEXANDER
28,0 cm, 11"
180-608-28



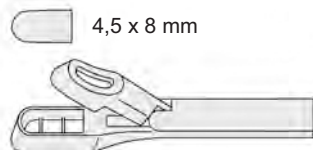
SCHUMACHER
24,0 cm, 9 1/2"
180-610-04



SCHUMACHER
24,0 cm, 9 1/2"
180-610-06

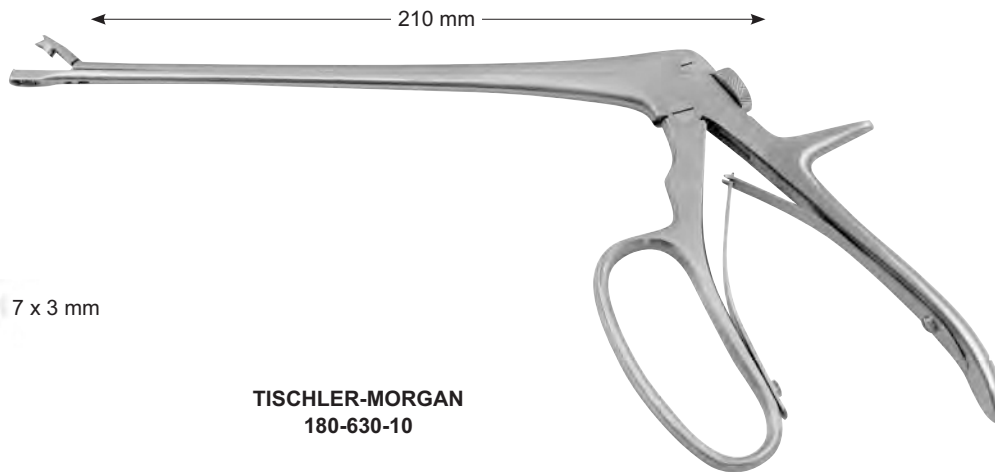
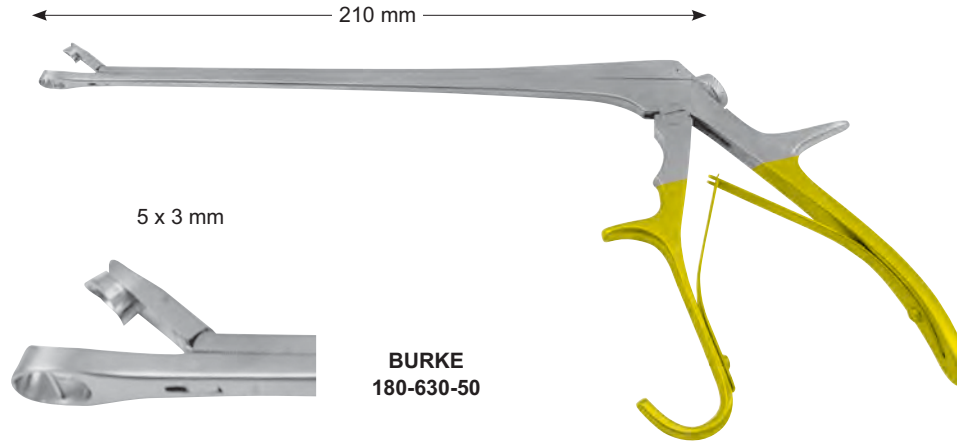


WITNER
23,0 cm, 9"
180-615-23



WITNER
23,0 cm, 9"
180-614-23

Uterus-Biopsiezangen
 Cervical Biopsy and Specimen Forceps
 Pinzas saca-bocados para biopsia
 Pinze per la biopsia cervicale e da prelievo



7 x 3 mm

2,3 x 4 mm

MINI-TOWNSEND
180-630-12

9 x 3 mm

TISCHLER-KEVORKIAN
180-630-41

2,3 x 4 mm

BABY-TISCHLER
180-630-14

9 x 3 mm

KEVORKIAN-PACIFIC
180-630-40



WRIGLEY
28,0 cm, 11"
181-056-28



SIMPSON
30,0 cm, 11³/₄"
181-034-30



SIMPSON-BRAUN
33,0 cm, 13"
181-036-33



SIMPSON-BRAUN
36,0 cm, 14¹/₈"
181-036-36



SIMPSON-LUIKART
36,0 cm, 14¹/₈"
181-046-36



DE LEE
30,0 cm, 11³/₄"
181-058-30



DE LEE
36,0 cm, 14¹/₈"
181-058-36



DE LEE
38,0 cm, 15³/₈"
181-058-38



MC LEAN
36,0 cm, 14¹/₈"
181-044-36



KIELAND
41,0 cm, 16"
181-052-41



KIELAND-LUIKART
40,0 cm, 15³/₄"
181-054-40



PIPER
44,0 cm, 17¹/₄"
181-060-44



ELLIOT
32,0 cm, 12¹/₂"
181-080-32



ELLIOT
38,0 cm, 15"
181-080-38



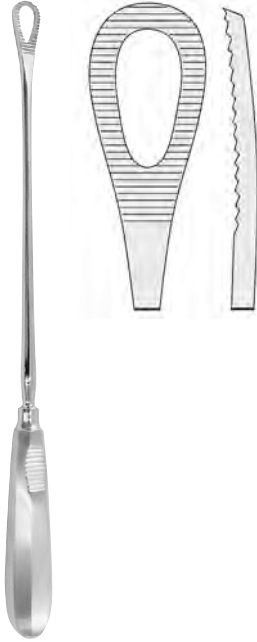
NAEGELE
36,0 cm, 14¹/₈"
181-084-36



NAEGELE
40,0 cm, 15³/₄"
181-084-40



GREEN-ARMYTAGE
21,0 cm, 8¹/₄"
181-200-21



PESTALOZZA
30,0 cm, 11³/₄"
181-252-30



SAENGER
27,0 cm, 10⁵/₈"
181-260-27



SAENGER
27,0 cm, 10⁵/₈"
181-261-27



WINTER
28,0 cm, 11"



Fig. 1
181-244-01



Fig. 2
181-244-02



Fig. 3
181-244-03



Fig. 1
181-245-01



Fig. 2
181-245-02



Fig. 3
181-245-03

Plazentar- und Abortuszangen
 Placenta and Ovum Forceps
 Pinzas para aborto y placenta
 Pinze per placenta e per ovaie



WALLICH
 42,0 cm, 16¹/₂"
 181-300-42



MARTIN
 34,0 cm, 13³/₈"
 181-600-34



gerade
 straight
 recto
 retto

BIERER
 33,0 cm, 13"
 58-1236-01



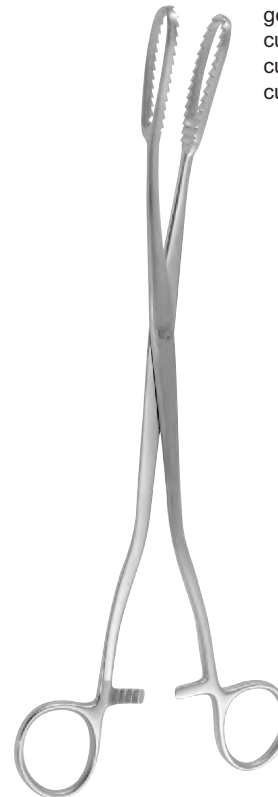
gerade
 straight
 recto
 retto

BIERER
 33,0 cm, 13"
 181-236-02



gebogen
 curved
 curvo
 curvo

BIERER
 33,0 cm, 13"
 181-237-01



gebogen
 curved
 curvo
 curvo

BIERER
 33,0 cm, 13"
 181-237-02

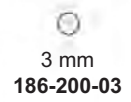
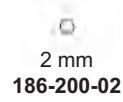


PIFFARD
 14,0 cm, 5³/₄"

Lupusküretten
 Lupus currettes
 Curetas para lupus
 Raschiatoio per lupus



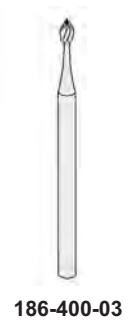
KEYES
 12,0 cm, 4³/₄"



KEYES
 12,0 cm, 4³/₄"
186-210-00



186-400-00
 komplett, complete,
 completo, completo,





UNNA
14,0 cm, 5³/₄"
186-000-14



UNNA
14,0 cm, 5³/₄"
186-002-14



SAALFELD
10,0 cm, 4"
186-010-10



SAALFELD
14,0 cm, 5³/₄"
186-012-14



SCHAMBERG
10,0 cm, 4"
186-020-10



WALTON
14,0 cm, 5³/₄"
186-030-14



FOX
14,0 cm, 5³/₄"



Lupusküretten
Lupus cures
Curetas para lupus
Raschiatoio per lupus



186-420-01

17,0 cm, 6³/₄"
 186-420-17



186-430-01

WALTON
 16,0 cm, 6¹/₄"
 186-430-16



RADOLF
 13,5 cm, 5³/₈"
 186-500-13



13,5 cm, 5³/₈"
 186-510-13



13,0 cm, 5"
 186-600-13



186-610-01

186-610-02

14,0 cm, 5¹/₂"



SCHEDE
 17,0 cm, 6³/₄"



Fig. 000
 192-467-03



Fig. 00
 192-467-02



Fig. 0
 192-467-01



Fig. 1
 192-467-11



Fig. 2
 192-467-12

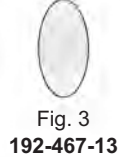


Fig. 3
 192-467-13



Fig. 4
 192-467-14



VOLKMANN
 17,0 cm, 6³/₄"



Fig. 0000
 192-469-04



Fig. 000
 192-469-03



Fig. 00
 192-469-02



Fig. 0
 192-469-01



Fig. 1
 192-469-11



Fig. 2
 192-469-12



Fig. 3
 192-469-13



Fig. 4
 192-469-14

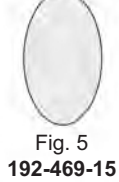


Fig. 5
 192-469-15



Fig. 6
 192-469-16



BRUNS
 17,0 cm, 6³/₄"

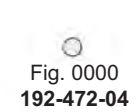


Fig. 0000
 192-472-04



Fig. 000
 192-472-03



Fig. 00
 192-472-02



Fig. 0
 192-472-01



Fig. 1
 192-472-11



Fig. 2
 192-472-12



Fig. 3
 192-472-13



Fig. 4
 192-472-14



Fig. 5
 192-472-15



Fig. 6
 192-472-16

Fig. 00000
192-448-04

Fig. 0000
192-448-03

Fig. 000
192-448-02

Fig. 00
192-448-01

Fig. 0
192-448-00



LEMPERT
21,5 cm, 8½"



HALLE
21,0 cm, 8¼"

Fig. 00
192-452-02

Fig. 0
192-452-01

Fig. 1
192-452-11



DAUBENSPECK
20,0 cm, 8"

Fig. 00
192-487-02

Fig. 0
192-487-01

Fig. 1
192-487-11

Fig. 2
192-487-12

Scharfe Löffel
 Bone Curettes
 Cucharillas cortantes
 Curetta per ossa



WILLIGER
 17,0 cm, 6³/₄"



Fig. 1
 192-430-11



Fig. 2
 192-430-12



WILLIGER
 14,0 cm, 5¹/₂"



Fig. 0
 192-406-00



Fig. 1
 192-406-01



Fig. 2
 192-406-02



MARTINI
 14,0 cm, 5¹/₂"
 192-408-00



Fig. 00/0
 192-408-00
 14,0 cm, 5¹/₂"



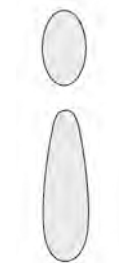
Fig. 0/1
 192-408-01
 14,0 cm, 5¹/₂"



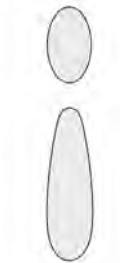
Fig. 1/2
 192-408-12
 14,0 cm, 5¹/₂"



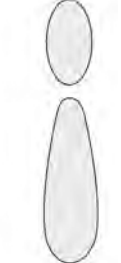
VOLKMANN



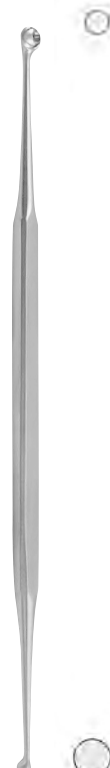
192-414-13
 13,0 cm, 5"



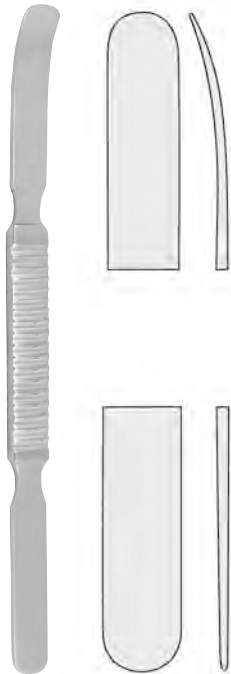
192-414-14
 14,0 cm, 5¹/₂"



192-414-17
 17,0 cm, 6³/₄"



JANZEN
 16,0 cm, 6¹/₄"
 192-410-16



WATSON-CHEYNE
17,5 cm, 6⁵/₈"
193-501-17



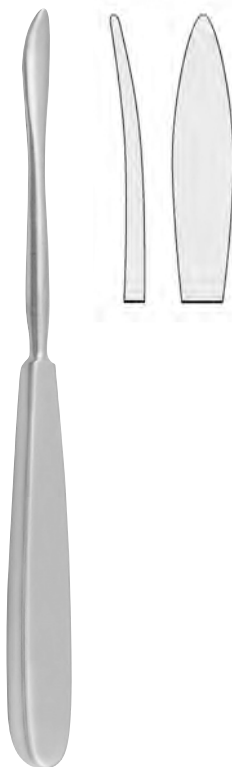
MC DONALD
19,0 cm, 7¹/₂"
193-440-19



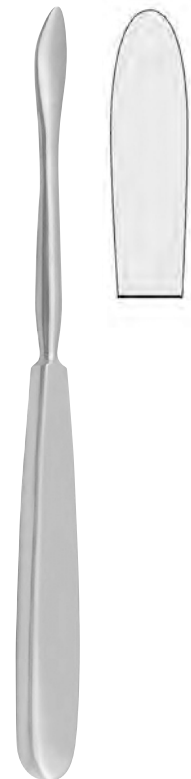
WILLIGER
17,0 cm, 6³/₄"
193-512-17



WILLIGER
16,0 cm, 6¹/₄"
193-512-16



LANGENBECK
20,0 cm, 8"
193-520-08



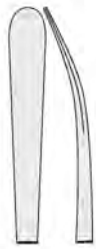
LANGENBECK
20,0 cm, 8"
193-520-10



ADSON
 17,0 cm, 6³/₄"



8 mm
 193-465-01



7 mm
 193-465-02



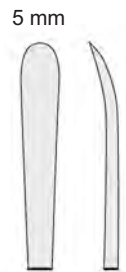
7 mm
 193-465-03



7 mm
 193-465-04



KÖNIG
 15,5 cm, 6"
 193-476-15



5 mm



10 mm
 193-477-10



15 mm
 193-477-15



20 mm
 193-477-20



25 mm
 193-477-25



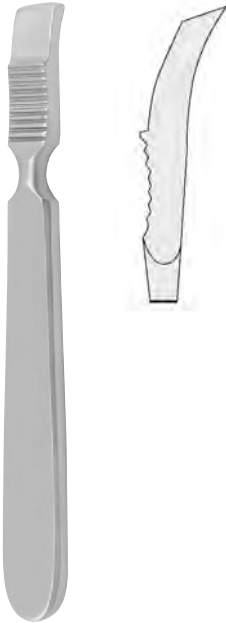
LAMBOTTE
 21,0 cm, 8¹/₄"

12,5 mm



FARABEUF
 15,0 cm, 6"
 193-478-15

12,5 mm



FARABEUF
15,0 cm, 6"
193-479-15

16,0 mm



LANGENBECK
19,0 cm, 7 1/2"
193-472-19

15,0 mm



SEDILLOT
21,0 cm, 8 1/4"
193-488-21



WILLIGER
16,0 cm, 6 1/4"

4 mm 193-480-04
6 mm 193-480-06
8 mm 193-480-08



für Kinder
for children
para niños
per bambini

DOYEN
17,0 cm, 6 3/4"
193-485-17



für Kinder
for children
para niños
per bambini

DOYEN
17,0 cm, 6 3/4"
193-487-17



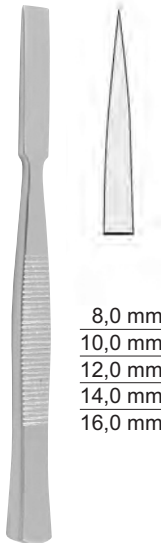
für Erwachsene
for adults
para adultos
per adulti дп

DOYEN
17,0 cm, 6 3/4"
193-481-17



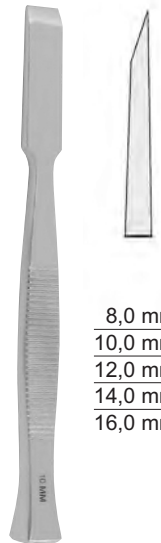
für Erwachsene
for adults
para adultos
per adulti

DOYEN
17,0 cm, 6 3/4"
193-483-17



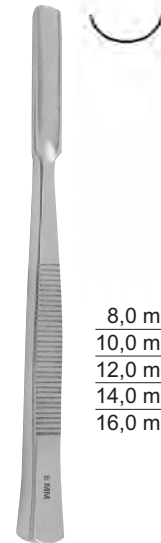
8,0 mm	194-300-08
10,0 mm	194-300-10
12,0 mm	194-300-12
14,0 mm	194-300-14
16,0 mm	194-300-16

13,5 cm, 5³/₈"



8,0 mm	194-301-08
10,0 mm	194-301-10
12,0 mm	194-301-12
14,0 mm	194-301-14
16,0 mm	194-301-16

13,5 cm, 5³/₈"



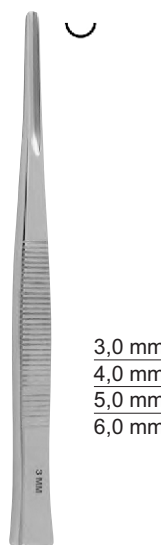
8,0 mm	194-302-08
10,0 mm	194-302-10
12,0 mm	194-302-12
14,0 mm	194-302-14
16,0 mm	194-302-16

13,5 cm, 5³/₈"



3,0 mm	194-334-03
4,0 mm	194-334-04
5,0 mm	194-334-05
6,0 mm	194-334-06

PARTSCH
13,5 cm, 5³/₈"



3,0 mm	194-336-03
4,0 mm	194-336-04
5,0 mm	194-336-05
6,0 mm	194-336-06

PARTSCH
13,5 cm, 5³/₈"



10,0 mm	194-361-10
15,0 mm	194-361-15
20,0 mm	194-361-20
25,0 mm	194-361-25

STILLE
20,0 cm, 8"



10,0 mm	194-360-10
15,0 mm	194-360-15
20,0 mm	194-360-20
25,0 mm	194-360-25

STILLE
20,0 cm, 8"



10,0 mm	194-362-10
15,0 mm	194-362-15
20,0 mm	194-362-20
25,0 mm	194-362-25

STILLE
20,0 cm, 8"



4,0 mm	194-318-04
6,0 mm	194-318-06
8,0 mm	194-318-08
10,0 mm	194-318-10
12,0 mm	194-318-12
14,0 mm	194-318-14

ALEXANDER
18,0 cm, 7"



4,0 mm	194-319-04
6,0 mm	194-319-06
8,0 mm	194-319-08
10,0 mm	194-319-10
12,0 mm	194-319-12
14,0 mm	194-319-14

ALEXANDER
18,0 cm, 7"



6,0 mm	194-350-06
9,0 mm	194-350-09
13,0 mm	194-350-13
16,0 mm	194-350-16
19,0 mm	194-350-19
25,0 mm	194-350-25
32,0 mm	194-350-32

SMITH-PETERSEN
20,0 cm, 8"



6,0 mm	194-351-06
9,0 mm	194-351-09
13,0 mm	194-351-13
16,0 mm	194-351-16
19,0 mm	194-351-19
25,0 mm	194-351-25
32,0 mm	194-351-32

SMITH-PETERSEN
20,0 cm, 8"

Flachmeißel, Hohlmeißel, Osteotome, Hämmer
 Chisels, Gouges, Osteotomes, Mallets
 Cinceles, Gubias, Osteótomos, Martillos
 Scalpelli, Sgorbie, Osteotomi, Martelli



9,0 mm	194-352-09
14,0 mm	194-352-14
16,0 mm	194-352-16
19,0 mm	194-352-19
25,0 mm	194-352-25

SMITH-PETERSEN
20,0 cm, 8"



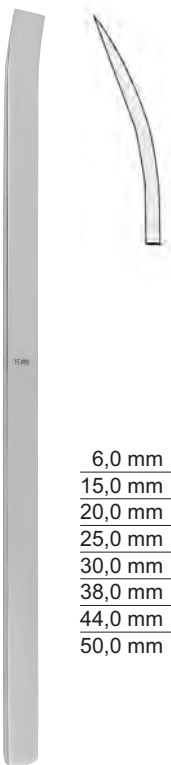
9,0 mm	194-353-09
14,0 mm	194-353-14
16,0 mm	194-353-16
19,0 mm	194-353-19
25,0 mm	194-353-25

SMITH-PETERSEN
20,0 cm, 8"



6,0 mm	194-450-06
15,0 mm	194-450-15
20,0 mm	194-450-20
25,0 mm	194-450-25
30,0 mm	194-450-30
38,0 mm	194-450-38
44,0 mm	194-450-44
50,0 mm	194-450-50

LAMBOTTE
24,0 cm, 9 1/2"



6,0 mm	194-451-06
15,0 mm	194-451-15
20,0 mm	194-451-20
25,0 mm	194-451-25
30,0 mm	194-451-30
38,0 mm	194-451-38
44,0 mm	194-451-44
50,0 mm	194-451-50

LAMBOTTE
24,0 cm, 9 1/2"

Ø 30 mm
220 g



COLLIN
20,0 cm, 8"
191-132-20

Ø 22 mm
200 g



PARTSCH
18,0 cm, 7"
191-145-18

mit Bleifüllung
lead filled head
cabezal relleno de plomo
testa di piombo

Ø 45 mm
300 g



BERGMANN
24,0 cm, 9 1/2"
191-201-24



20,0 cm, 8"
250-160-20



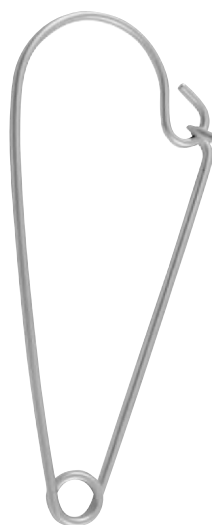
CHEATTLE
27,0 cm, 10⁵/₈"
250-163-27



ROGGE
23,0 cm, 9"
250-164-23



MAYO
14,0 cm, 5¹/₂"
250-151-14



BUNT
12,0 cm, 4³/₄"
250-154-12



Ø 75 x 130 mm	250-142-06
Ø 75 x 175 mm	250-142-07
Ø 100 x 175 mm	250-142-08
Ø 100 x 200 mm	250-142-09



Ø 40,0 mm	250-130-04
Ø 60,0 mm	250-130-06
Ø 80,0 mm	250-130-08
Ø 100,0 mm	250-130-10
Ø 120,0 mm	250-130-12
Ø 150,0 mm	250-130-15



165 x 55 mm	0,75 l	250-133-00
175 x 70 mm	1,00 l	250-133-10
225 x 100 mm	2,00 l	250-133-20
240 x 95 mm	2,75 l	250-133-30
260 x 120 mm	4,00 l	250-133-40
290 x 100 mm	5,00 l	250-133-50
315 x 150 mm	5,50 l	250-133-60
325 x 135 mm	8,00 l	250-133-70
360 x 165 mm	12,00 l	250-133-80
415 x 150 mm	14,00 l	250-133-90



170 mm	250-140-17
250 mm	250-140-25
275 mm	250-140-27



200 x 150 x 25 mm	250-200-01
260 x 180 x 30 mm	250-200-02
300 x 220 x 30 mm	250-200-03
350 x 220 x 40 mm	250-200-04
220 x 170 x 50 mm	250-200-05
280 x 200 x 50 mm	250-200-06
320 x 240 x 50 mm	250-200-07
370 x 270 x 50 mm	250-200-08
420 x 320 x 50 mm	250-200-09

250-300-00
 Ø 65 x 17 mm
 Außen- und Innendose
 Exterior and interior box
 Caja exterior e interior
 Scatola esterna es interiore

250-300-01
 Ø 62 x 13 mm
 Innendose allein
 Interior box only
 Caja interior, suelta
 Scatola interiore sola



25 ccm
250-310-25

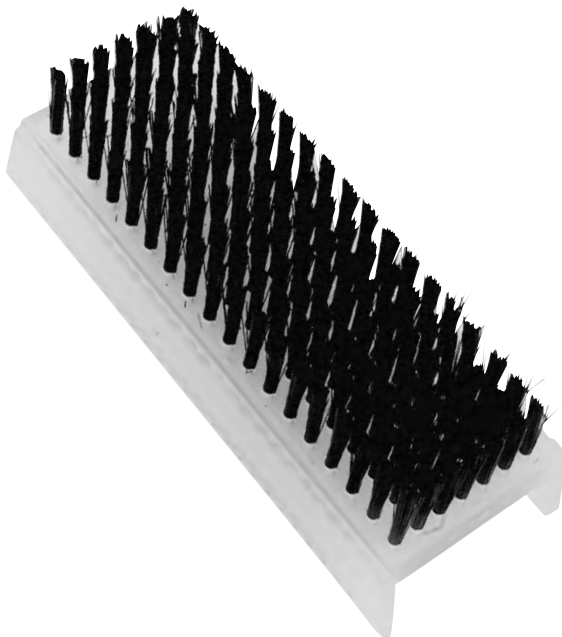


50 ccm
250-310-50



Bürstenspender für 10 Bürsten
Brush dispenser for 10 brushes
Distribuidor de cepillos para 10 cepillos
Distributore per 10 spazzole
260 x 155 x 65 mm
250-800-01

Bürstenspender für 20 Bürsten
Brush dispenser for 20 brushes
Distribuidor de cepillos para 20 cepillos
Distributore per 20 spazzole
270 x 240 x 65 mm
250-800-02



250-800-10

mehr als 400x autoklavierbar
more than 400 times autoclavable
esterilizable más de 400 veces en autoclave
sterilizzabile più di 400 volte in autoclave

003-003-00	2	003-250-17	8	010-052-12	16	010-114-23	22
003-003-01	2	003-250-20	8	010-052-13	16	010-114-25	22
003-003-02	2	003-250-22	8	010-052-14	16	010-114-28	22
003-004-00	3	003-400-19	11	010-053-12	16	010-114-30	22
003-004-01	3	003-401-19	11	010-053-13	16	010-115-14	20
003-007-00	2	003-410-30	11	010-053-14	16	010-115-18	22
003-007-01	2	003-411-30	11	010-054-12	16	010-115-20	22
003-008-00	3	003-412-35	11	010-054-13	16	010-115-23	22
003-009-00	3	003-413-35	11	010-054-14	16	010-115-25	22
003-050-10	4	003-420-30	11	010-055-12	16	010-115-28	22
003-050-11	4	003-421-30	11	010-055-13	16	010-115-30	22
003-050-11S	4	003-422-30	10	010-055-14	16	010-120-14	22
003-050-12	4	010-000-10	14	010-070-13	17	010-120-18	22
003-050-12D	4	010-000-11	14	010-070-14	17	010-120-20	22
003-050-13	4	010-000-13	14	010-071-13	17	010-120-23	22
003-050-15	4	010-000-14	14	010-071-14	17	010-120-25	22
003-050-15C	4	010-000-15	14	010-072-13	17	010-120-28	22
003-050-18	5	010-000-16	14	010-072-14	17	010-120-30	22
003-050-19	5	010-000-17	14	010-073-13	17	010-121-14	22
003-050-20	5	010-000-18	14	010-073-14	17	010-121-18	23
003-050-21	5	010-000-20	14	010-074-13	18	010-121-20	23
003-050-22	5	010-001-10	14	010-074-14	18	010-121-23	23
003-050-23	5	010-001-11	14	010-075-13	18	010-121-25	23
003-050-24	5	010-001-13	14	010-075-14	18	010-121-28	23
003-050-25	5	010-001-14	14	010-100-14	18	010-121-30	23
003-060-10	6	010-001-15	14	010-100-17	18	010-124-18	23
003-060-12	6	010-001-16	14	010-100-23	18	010-124-20	23
003-060-14	6	010-001-17	14	010-100-28	18	010-124-23	23
003-060-16	6	010-001-18	14	010-101-14	18	010-124-25	23
003-060-18	6	010-001-20	14	010-101-17	18	010-124-28	23
003-066-01	6	010-002-10	14	010-101-23	18	010-124-30	23
003-066-02	6	010-002-11	14	010-101-28	18	010-125-18	23
003-066-03	6	010-002-13	14	010-102-15	19	010-125-20	23
003-066-04	6	010-002-14	14	010-102-17	19	010-125-23	23
003-066-05	6	010-002-15	14	010-102-19	19	010-125-25	23
003-066-06	6	010-002-16	14	010-102-21	19	010-125-28	23
003-070-01	7	010-002-17	14	010-103-15	19	010-125-30	23
003-070-02	7	010-002-18	14	010-103-17	19	010-127-18	24
003-070-03	7	010-002-20	14	010-103-19	19	010-127-20	24
003-070-04	7	010-003-10	14	010-103-21	19	010-127-23	24
003-070-05	7	010-003-11	14	010-104-17	19	010-129-18	24
003-070-06	7	010-003-13	14	010-105-17	19	010-129-20	24
003-070-07	7	010-003-14	14	010-110-11	20	010-129-23	24
003-070-08	7	010-003-15	14	010-110-14	20	010-137-14	24
003-070-09	7	010-003-16	14	010-110-18	21	010-139-17	24
003-070-10	7	010-003-17	14	010-110-20	21	010-140-10	25
003-076-01	7	010-003-18	14	010-110-23	21	010-140-16	25
003-076-02	7	010-003-20	14	010-110-25	21	010-140-21	25
003-076-03	7	010-004-10	15	010-110-28	21	010-141-10	25
003-076-04	7	010-004-11	15	010-110-30	21	010-141-16	25
003-076-05	7	010-004-13	15	010-111-11	20	010-141-21	25
003-076-06	7	010-004-14	15	010-111-14	20	010-160-17	25
003-076-07	7	010-004-15	15	010-111-18	21	010-161-17	25
003-076-08	7	010-004-16	15	010-111-20	21	010-200-12	26
003-076-09	7	010-004-17	15	010-111-23	21	010-200-15	26
003-078-15	7	010-004-18	15	010-111-25	21	010-200-18	26
003-078-16	7	010-004-20	15	010-111-28	21	010-200-20	26
003-080-13	8	010-005-10	15	010-111-30	21	010-201-12	26
003-080-16	8	010-005-11	15	010-112-18	21	010-201-15	26
003-080-19	8	010-005-13	15	010-112-20	21	010-201-18	26
003-080-22	8	010-005-14	15	010-112-23	21	010-201-20	26
003-080-28	8	010-005-15	15	010-112-25	21	010-210-15	26
003-082-16	8	010-005-16	15	010-112-28	21	010-210-18	26
003-082-19	8	010-005-17	15	010-112-30	21	010-211-15	26
003-082-22	8	010-005-18	15	010-113-14	20	010-211-18	26
003-105-55	10	010-005-20	15	010-113-18	21	010-211-20	26
003-110-65	10	010-009-13	19	010-113-20	21	010-211-23	26
003-150-11	9	010-050-12	15	010-113-23	21	010-211-25	26
003-150-14	9	010-050-13	15	010-113-25	21	010-217-19	27
003-150-17	9	010-050-14	15	010-113-28	21	010-217-25	27
003-180-16	9	010-051-12	15	010-113-30	21	010-220-15	27
003-180-20	9	010-051-13	15	010-114-18	22	010-221-15	27
003-180-24	9	010-051-14	15	010-114-20	22	010-224-14	27

010-225-14	27	010-540-45	36	010-701-20	43	011-112-14	48
010-228-14	27	010-540-60	36	010-703-20	43	011-112-18	49
010-229-14	27	010-541-25	36	010-706-10	43	011-112-20	49
010-230-12	28	010-541-45	36	010-707-13	43	011-112-23	49
010-231-12	28	010-541-60	36	010-707-16	43	011-112-25	49
010-234-12	28	010-542-25	36	010-709-16	43	011-112-28	49
010-235-12	28	010-542-45	36	010-800-12	44	011-112-30	49
010-240-11	28	010-542-60	36	010-900-09	44	011-113-14	48
010-241-11	28	010-543-25	36	010-900-11	44	011-113-18	49
010-244-09	28	010-543-45	36	010-900-14	44	011-113-20	49
010-244-10	28	010-543-60	36	010-900-18	44	011-113-23	49
010-244-11	28	010-544-25	36	010-900-20	44	011-113-25	49
010-245-09	28	010-544-45	36	010-901-18	44	011-113-28	49
010-245-10	28	010-544-60	36	010-901-21	44	011-113-30	49
010-245-11	28	010-547-18	37	010-903-16	44	011-114-14	48
010-250-10	29	010-548-21	37	010-903-19	44	011-114-18	49
010-250-11	29	010-548-24	37	010-905-23	44	011-114-20	49
010-251-10	29	010-550-12	37	010-907-20	45	011-114-23	49
010-251-11	29	010-550-25	37	010-907-22	45	011-114-25	49
010-261-11	29	010-550-45	37	010-909-24	45	011-114-28	49
010-263-11	29	010-550-60	37	010-910-24	45	011-114-30	49
010-264-12	30	010-550-90	37	010-920-14	45	011-115-14	48
010-265-12	30	010-552-12	38	010-930-23	45	011-115-18	49
010-270-08	30	010-560-15	38	010-940-16	45	011-115-20	49
010-271-08	30	010-561-15	38	010-940-18	45	011-115-23	49
010-276-14	31	010-562-15	38	010-940-20	45	011-115-25	49
010-277-14	31	010-570-19	39	010-940-23	45	011-115-28	49
010-280-12	31	010-572-11	39	010-941-20	45	011-115-30	49
010-283-12	31	010-575-30	39	010-950-14	45	011-120-14	49
010-285-12	31	010-577-24	39	010-950-16	45	011-120-18	50
010-290-10	31	010-579-23	39	010-950-18	45	011-120-20	50
010-290-11	31	010-600-20	39	011-000-14	46	011-120-23	50
010-291-10	31	010-600-23	39	011-000-16	46	011-120-25	50
010-291-11	31	010-601-20	40	011-000-18	46	011-120-28	50
010-294-10	31	010-601-23	40	011-001-14	46	011-120-30	50
010-294-11	31	010-602-20	39	011-001-16	46	011-121-14	49
010-295-10	31	010-602-23	39	011-001-18	46	011-121-18	50
010-295-11	31	010-603-20	40	011-002-14	46	011-121-20	50
010-300-13	32	010-603-23	40	011-002-16	46	011-121-23	50
010-300-14	32	010-604-20	39	011-002-18	46	011-121-25	50
010-302-16	32	010-604-23	39	011-003-14	46	011-121-28	50
010-310-14	32	010-605-20	40	011-003-16	46	011-121-30	50
010-312-12	32	010-605-23	40	011-003-18	46	011-124-14	49
010-315-16	32	010-610-16	40	011-004-14	46	011-124-18	50
010-315-18	32	010-610-17	40	011-004-16	46	011-124-20	50
010-324-18	32	010-611-16	40	011-004-18	46	011-124-23	50
010-325-18	33	010-611-17	40	011-005-14	46	011-124-25	50
010-341-19	33	010-612-16	40	011-005-16	46	011-124-28	50
010-343-15	33	010-620-24	40	011-005-18	46	011-124-30	50
010-400-09	33	010-622-22	40	011-100-14	47	011-125-14	49
010-400-10	33	010-634-16	40	011-100-17	47	011-125-18	50
010-400-13	33	010-634-18	40	011-100-23	47	011-125-20	50
010-402-11	33	010-635-16	41	011-101-14	47	011-125-23	50
010-402-14	33	010-635-18	41	011-101-17	47	011-125-25	50
010-404-14	33	010-640-19	41	011-101-23	47	011-125-28	50
010-404-18	33	010-640-23	41	011-102-15	47	011-125-30	50
010-408-16	34	010-650-18	41	011-102-17	47	011-127-18	51
010-413-13	34	010-651-18	41	011-110-11	48	011-127-20	51
010-415-12	34	010-670-21	41	011-110-14	48	011-127-23	51
010-450-22	34	010-672-21	41	011-110-18	48	011-129-18	51
010-453-17	34	010-674-21	41	011-110-20	48	011-129-20	51
010-457-17	35	010-677-27	41	011-110-23	48	011-129-23	51
010-458-17	35	010-680-31	42	011-110-25	48	011-137-14	50
010-459-17	35	010-681-31	42	011-110-28	48	011-139-17	50
010-501-18	35	010-685-32	42	011-110-30	48	011-140-16	47
010-511-16	35	010-688-25	42	011-111-11	48	011-140-21	47
010-517-18	35	010-688-28	42	011-111-14	48	011-141-16	47
010-519-22	35	010-689-25	42	011-111-18	48	011-141-21	47
010-521-18	36	010-689-28	42	011-111-20	48	011-210-15	51
010-523-17	36	010-691-19	42	011-111-23	48	011-211-15	51
010-525-19	36	010-693-27	42	011-111-25	48	011-244-11	55
010-528-20	36	010-695-18	43	011-111-28	48	011-245-11	55
010-540-25	36	010-701-14	43	011-111-30	48	011-543-25	53

011-543-45	53	018-232-15Z	61	020-010-25	64	020-206-30	71
011-543-60	53	018-241-14Z	59	020-010-30	64	020-208-15	72
011-545-25	53	018-241-16Z	59	020-011-10	65	020-209-15	72
011-545-45	53	018-243-14	59	020-011-11	65	020-210-13	70
011-545-60	53	018-243-16	59	020-011-13	65	020-210-14	70
011-548-24	53	018-246-01	59	020-011-14	65	020-210-15	70
011-550-25	54	018-246-02	59	020-011-16	65	020-210-16	70
011-550-45	54	018-246-03	59	020-011-18	65	020-210-18	70
011-550-60	54	018-270-12	60	020-011-20	65	020-210-20	70
011-550-90	54	018-270-25	60	020-011-25	65	020-210-25	70
011-551-25	54	018-270-45	60	020-011-30	65	020-210-30	70
011-551-40	54	018-270-60	60	020-012-13	65	020-212-12	71
011-551-60	54	018-270-90	60	020-012-14	65	020-212-13	71
011-552-17	53	018-271-12	60	020-012-15	65	020-212-14	71
011-600-20	52	018-271-25	60	020-012-18	65	020-212-15	71
011-600-23	52	018-271-45	60	020-012-20	65	020-212-18	71
011-601-20	52	018-271-60	60	020-012-25	65	020-212-20	71
011-601-23	52	018-271-90	60	020-018-10	65	020-212-25	71
011-602-20	52	018-290-01	59	020-018-11	65	020-212-30	71
011-602-23	52	018-290-02	59	020-018-13	65	020-218-13	70
011-603-20	52	018-290-03	59	020-018-14	65	020-218-14	70
011-603-23	52	018-290-04	59	020-018-16	65	020-218-15	70
011-604-20	52	018-291-01	59	020-018-18	65	020-218-16	70
011-604-23	52	018-291-02	59	020-018-20	65	020-218-18	70
011-605-20	52	018-291-03	59	020-018-25	65	020-218-20	70
011-605-23	52	018-291-04	59	020-018-30	65	020-218-25	70
011-663-25	51	018-292-01	59	020-026-18	67	020-218-30	70
011-665-25	51	018-292-02	59	020-026-21	67	020-219-13	70
011-800-12	55	018-293-01	59	020-026-25	67	020-219-14	70
011-900-18	55	018-293-02	59	020-027-18	67	020-219-16	70
011-909-24	55	020-002-10	64	020-027-21	67	020-219-18	70
012-100-17	56	020-002-11	64	020-027-25	67	020-219-20	70
012-101-17	56	020-002-13	64	020-036-13	67	020-226-18	74
012-110-11	57	020-002-14	64	020-036-14	67	020-226-21	74
012-110-14	57	020-002-15	64	020-036-15	67	020-226-25	74
012-111-14	56	020-002-16	64	020-040-12	67	020-227-18	74
012-111-18	56	020-002-18	64	020-040-15	67	020-227-21	74
012-111-20	56	020-002-20	64	020-070-12	66	020-227-25	74
012-111-23	56	020-002-25	64	020-070-15	66	020-236-13	70
012-121-14	56	020-002-30	64	020-076-12	66	020-236-14	70
012-121-18	56	020-003-10	64	020-076-15	66	020-236-15	70
012-121-20	56	020-003-11	64	020-092-17	67	020-240-12	73
012-121-23	56	020-003-13	64	020-093-17	67	020-240-15	73
012-129-15	56	020-003-14	64	020-094-20	67	020-242-12	73
012-129-19	56	020-003-16	64	020-095-20	68	020-252-11	69
012-130-13	56	020-003-18	64	020-102-18	66	020-252-13	69
012-133-18	56	020-003-20	64	020-103-18	67	020-252-14	69
012-139-17	56	020-003-25	64	020-114-17	66	020-252-16	69
012-200-12	58	020-003-30	64	020-115-17	66	020-252-18	69
012-201-12	58	020-004-10	64	020-117-18	66	020-252-20	69
012-210-12	57	020-004-11	64	020-120-18	68	020-252-25	69
012-218-15	57	020-004-13	64	020-126-20	68	020-252-30	69
012-218-18	57	020-004-14	64	020-130-15	68	020-254-13	69
012-240-11	57	020-004-16	64	020-130-20	68	020-254-14	69
012-241-11	57	020-004-18	64	020-136-18	68	020-254-16	69
012-244-11	57	020-004-20	64	020-158-15	66	020-254-18	69
012-245-11	57	020-004-25	64	020-200-10	69	020-254-20	69
012-290-11	57	020-004-30	64	020-200-11	69	020-256-13	69
012-291-11	57	020-006-13	65	020-200-13	69	020-256-14	69
012-343-15	58	020-006-14	65	020-200-14	69	020-256-16	69
012-511-16	58	020-006-15	65	020-200-15	69	020-256-18	69
012-551-25	58	020-006-18	65	020-200-16	69	020-256-20	69
012-551-45	58	020-006-20	65	020-200-18	69	020-270-12	71
012-551-60	58	020-006-25	65	020-200-20	69	020-270-15	71
018-081-11	59	020-006-30	65	020-200-25	69	020-276-12	71
018-083-11	59	020-008-15	66	020-200-30	69	020-276-15	71
018-201-15	60	020-010-10	64	020-206-12	71	020-282-12	72
018-201-18	60	020-010-11	64	020-206-13	71	020-288-12	72
018-203-15	61	020-010-13	64	020-206-14	71	020-288-15	72
018-203-18	61	020-010-14	64	020-206-15	71	020-292-17	74
018-223-15	60	020-010-16	64	020-206-18	71	020-293-17	74
018-223-15Z	60	020-010-18	64	020-206-20	71	020-294-20	74
018-232-15	61	020-010-20	64	020-206-25	71	020-295-20	74

020-300-15	72	020-663-11	77	021-140-25	82	030-160-18	90
020-302-18	73	020-663-13	77	021-158-15	83	030-160-20	90
020-303-18	73	020-663-14	77	021-200-14	82	030-160-25	90
020-314-17	73	020-666-08	77	021-200-18	82	030-161-18	90
020-315-17	73	020-666-09	77	021-200-20	82	030-161-20	90
020-317-17	73	020-666-10	77	021-200-25	82	030-161-25	90
020-330-15	74	020-666-11	77	021-270-12	83	030-170-18	90
020-330-20	74	020-666-13	77	021-270-15	83	030-170-20	90
020-358-15	73	020-666-14	77	021-300-15	83	030-170-25	90
020-382-15	72	020-667-08	77	021-302-17	83	030-171-18	90
020-382-20	72	020-667-09	77	021-590-17	83	030-171-20	90
020-384-15	72	020-667-10	77	026-014-03	94	030-171-25	90
020-384-20	72	020-667-11	77	026-014-05	94	030-180-25	90
020-410-15	76	020-667-13	77	026-015-03	94	030-181-25	90
020-410-20	76	020-667-14	77	026-015-05	94	030-190-18	90
020-410-25	76	020-700-16	81	026-018-04	94	030-190-25	90
020-420-14	76	020-700-20	81	026-018-05	94	030-200-22	89
020-420-20	76	020-700-24	81	026-018-06	94	030-200-25	89
020-422-14	76	020-700-30	81	026-018-07	94	030-200-27	89
020-422-20	76	020-701-16	81	026-018-09	94	030-201-22	89
020-456-15	74	020-701-20	81	026-019-04	94	030-201-25	89
020-456-20	74	020-701-24	81	026-019-05	94	030-201-27	89
020-456-25	74	020-701-30	81	026-019-06	94	030-210-20	90
020-460-14	75	020-702-16	81	026-019-07	94	030-210-22	90
020-460-16	75	020-702-20	81	026-019-09	94	030-210-25	90
020-460-20	75	020-702-24	81	026-292-07	95	030-210-27	90
020-470-12	75	020-702-30	81	026-292-08	95	030-211-20	90
020-470-20	68	020-703-16	81	026-292-10	95	030-211-22	90
020-470-23	75	020-703-20	81	026-292-12	95	030-211-25	90
020-470-34	75	020-703-24	81	026-293-07	95	030-211-27	90
020-494-01	75	020-703-30	81	026-293-08	95	030-300-25	89
020-494-02	75	020-704-16	81	026-293-10	95	030-303-25	89
020-494-03	75	020-704-20	81	026-293-12	95	030-310-25	89
020-510-13	76	020-704-24	81	026-295-23	94	030-311-25	89
020-510-15	76	020-704-30	81	026-298-07	96	030-320-26	88
020-516-23	68	020-706-16	81	026-298-09	96	030-321-26	89
020-518-15	75	020-706-20	81	026-298-11	96	030-351-13	88
020-518-20	75	020-706-24	81	026-299-06	96	030-360-13	88
020-518-23	75	020-706-30	81	026-299-09	96	030-360-16	88
020-520-18	76	020-708-16	81	026-299-11	96	030-360-18	88
020-522-18	76	020-708-20	81	026-520-01	94	032-002-15	91
020-586-14	75	020-708-24	81	026-520-02	94	032-002-18	91
020-587-14	75	020-708-30	81	027-032-35	95	032-002-20	91
020-590-18	76	020-716-16	81	027-032-40	95	032-004-15	91
020-592-18	76	020-716-20	81	027-033-35	95	032-004-18	91
020-601-03	80	020-716-24	81	027-033-40	95	032-004-20	91
020-601-04	80	020-716-30	81	027-042-35	95	032-006-14	91
020-601-05	80	020-718-16	81	027-042-40	95	032-012-16	91
020-601-07	80	020-718-20	81	027-043-35	95	032-012-18	91
020-620-01	80	020-718-24	81	027-043-40	95	032-012-20	91
020-620-02	80	020-718-30	81	030-000-09	86	040-000-10	99
020-620-03	80	020-806-10	78	030-000-11	86	040-001-10	99
020-620-04	80	020-807-10	78	030-000-13	86	040-010-10	98
020-634-12	81	020-809-10	78	030-000-15	86	040-016-10	98
020-634-13	81	020-810-10	79	030-005-11	86	040-020-10	101
020-635-13	81	020-811-10	79	030-010-13	86	040-020-12	101
020-637-13	81	020-813-10	79	030-010-15	87	040-021-10	101
020-650-07	78	020-814-10	79	030-014-10	87	040-021-12	101
020-650-09	78	020-815-10	79	030-014-13	87	040-030-10	101
020-650-11	78	020-817-10	79	030-020-10	88	040-030-12	101
020-652-10	78	021-026-15	83	030-020-13	88	040-031-10	101
020-653-10	78	021-026-18	83	030-024-13	87	040-031-12	101
020-656-10	78	021-026-20	83	030-030-14	88	040-050-12	100
020-657-10	78	021-040-12	82	030-040-15	87	040-050-14	100
020-662-08	77	021-040-15	82	030-040-18	87	040-050-18	100
020-662-09	77	021-070-12	83	030-040-20	87	040-050-21	100
020-662-10	77	021-070-15	83	030-044-16	87	040-051-12	100
020-662-11	77	021-092-17	83	030-101-09	86	040-051-14	100
020-662-13	77	021-093-17	83	030-105-05	86	040-051-18	100
020-662-14	77	021-102-17	83	030-105-07	86	040-051-21	100
020-663-08	77	021-117-18	83	030-105-09	86	040-070-12	100
020-663-09	77	021-140-15	82	030-107-09	86	040-070-14	100
020-663-10	77	021-140-23	82	030-109-09	86	040-070-18	100

040-070-21	100	040-353-16	105	040-443-26	111	040-611-21	122
040-071-12	100	040-354-15	103	040-444-21	111	040-611-23	122
040-071-14	100	040-356-15	103	040-444-26	111	040-613-21	122
040-071-18	100	040-358-15	97	040-445-21	111	040-613-23	122
040-071-21	100	040-358-20	97	040-445-26	111	040-614-21	121
040-150-14	101	040-364-14	97	040-448-22	107	040-615-21	121
040-151-14	101	040-366-19	97	040-449-22	107	040-617-21	121
040-152-16	101	040-368-14	99	040-450-24	107	040-621-19	121
040-153-16	101	040-368-16	99	040-451-24	107	040-623-21	121
040-160-14	102	040-369-13	98	040-453-24	104	040-625-23	120
040-161-14	102	040-370-13	96	040-455-01	113	040-629-21	120
040-170-14	102	040-372-13	96	040-455-02	113	040-630-21	119
040-171-14	102	040-376-16	96	040-456-22	115	040-631-21	119
040-180-16	103	040-380-15	102	040-456-23	115	040-650-16	98
040-181-16	103	040-381-15	102	040-456-24	115	040-650-20	98
040-182-16	103	040-382-15	102	040-457-28	114	040-651-16	98
040-183-16	103	040-383-15	102	040-459-18	113	040-651-20	98
040-260-14	106	040-384-20	106	040-459-28	113	040-656-15	98
040-260-16	106	040-384-26	106	040-461-15	113	040-658-25	97
040-260-18	106	040-385-20	106	040-461-19	113	040-658-27	97
040-260-20	106	040-385-26	106	040-463-19	111	040-701-14	118
040-260-22	106	040-386-20	106	040-463-22	111	040-703-18	118
040-260-24	106	040-386-26	106	040-463-24	111	040-709-20	118
040-260-26	106	040-387-20	106	040-465-19	111	040-721-20	119
040-260-30	106	040-387-26	106	040-465-22	111	040-723-20	119
040-261-14	106	040-390-20	107	040-465-24	111	050-010-12	124
040-261-16	106	040-391-20	107	040-467-19	111	050-020-12	124
040-261-18	106	040-393-20	107	040-467-22	111	050-022-12	124
040-261-20	106	040-409-14	108	040-467-24	111	050-028-13	124
040-261-22	106	040-411-14	108	040-471-21	108	050-030-13	124
040-261-24	106	040-411-18	108	040-473-22	113	050-040-13	124
040-261-26	106	040-421-01	110	040-473-23	113	050-046-13	124
040-261-30	106	040-421-02	110	040-475-01	99	050-048-14	124
040-262-13	105	040-421-03	110	040-475-02	99	050-060-15	125
040-262-14	105	040-421-04	110	040-475-18	108	050-070-15	125
040-262-16	105	040-421-05	110	040-477-15	113	050-072-17	125
040-263-13	105	040-421-06	110	040-477-19	113	050-080-14	126
040-263-14	105	040-421-07	110	040-479-22	114	050-080-16	126
040-263-16	105	040-422-01	110	040-479-25	114	050-080-18	126
040-290-13	99	040-422-02	110	040-479-28	114	050-080-20	126
040-290-15	99	040-422-03	110	040-480-15	105	050-080-24	126
040-290-18	99	040-422-04	110	040-480-18	105	050-080-26	126
040-290-20	99	040-422-05	110	040-481-15	105	050-080-30	126
040-291-13	99	040-422-06	110	040-481-18	105	050-090-16	126
040-291-15	99	040-422-07	110	040-497-20	108	050-090-18	126
040-291-18	99	040-423-01	109	040-501-19	114	050-090-20	126
040-291-20	99	040-423-02	109	040-501-23	114	050-096-13	125
040-340-16	105	040-423-03	109	040-503-18	114	050-110-15	126
040-340-20	105	040-423-04	109	040-505-24	115	050-141-21	127
040-341-16	105	040-424-14	102	040-507-22	115	050-148-23	127
040-341-20	105	040-429-18	112	040-509-20	116	050-150-27	127
040-347-14	102	040-429-22	112	040-509-22	116	050-160-27	127
040-350-14	106	040-429-25	112	040-509-24	116	050-190-18	125
040-350-16	106	040-429-28	112	040-511-23	116	050-192-18	125
040-350-18	106	040-431-14	112	040-513-23	116	050-193-27	127
040-350-20	106	040-431-16	112	040-517-23	117	050-211-27	127
040-350-22	106	040-431-18	112	040-523-22	115	050-230-23	128
040-350-24	106	040-431-20	112	040-523-23	115	050-306-14	128
040-350-26	106	040-431-23	112	040-525-22	115	050-310-14	128
040-350-30	106	040-431-25	112	040-525-23	115	050-310-17	128
040-351-14	106	040-431-28	112	040-529-21	114	050-310-18	128
040-351-16	106	040-433-20	112	040-533-01	107	050-350-14	129
040-351-18	106	040-433-24	112	040-533-02	107	050-350-17	129
040-351-20	106	040-433-28	112	040-540-19	103	050-350-20	129
040-351-22	106	040-436-21	114	040-541-19	103	050-354-14	129
040-351-24	106	040-438-21	114	040-543-19	112	050-354-17	129
040-351-26	106	040-441-01	109	040-543-21	112	050-356-17	129
040-351-30	106	040-441-02	109	040-543-24	112	050-356-20	129
040-352-13	105	040-441-03	109	040-601-24	119	050-358-14	130
040-352-14	105	040-441-04	109	040-602-25	119	050-358-17	130
040-352-16	105	040-442-21	111	040-606-20	120	050-358-20	130
040-353-13	105	040-442-26	111	040-606-25	120	050-362-18	128
040-353-14	105	040-443-21	111	040-607-21	121	050-550-10	130

050-551-10	130	051-224-18	134	056-333-21	147	062-058-01	158
050-570-14	131	051-224-20	134	056-333-27	147	062-058-02	158
050-570-18	131	051-224-26	134	056-450-20	147	062-058-03	158
050-571-14	131	051-230-22	140	056-451-19	147	062-060-13	158
050-571-18	131	051-230-23	140	056-451-20	147	062-070-01	159
050-576-14	131	051-240-15	139	056-452-01	148	062-070-02	159
050-576-18	131	051-242-20	139	056-452-02	148	062-070-03	159
050-577-14	131	051-250-16	133	056-452-03	148	062-070-04	159
050-577-18	131	051-250-18	133	056-454-01	148	062-074-16	158
050-600-18	131	051-250-20	133	056-454-02	148	062-078-01	158
050-601-14	130	051-250-23	133	056-455-25	148	062-078-02	158
050-601-18	131	051-250-26	133	056-458-21	148	062-080-01	159
050-621-13	130	051-310-14	140	056-460-01	149	062-080-02	159
050-630-18	131	051-310-17	140	056-460-02	149	062-082-01	160
050-631-18	131	051-310-18	140	056-460-03	149	062-082-02	160
050-650-14	132	051-330-16	140	056-467-01	149	062-088-02	160
050-651-14	132	051-350-14	141	056-467-02	149	062-088-03	160
050-653-14	132	051-350-17	141	056-468-15	149	062-088-04	160
050-661-14	132	051-350-20	141	056-469-14	149	062-089-02	160
050-663-14	132	051-356-17	142	056-470-01	149	062-089-03	160
050-671-13	132	051-356-20	142	056-470-02	150	062-089-04	160
050-673-13	132	051-356-23	142	056-472-23	150	062-101-01	160
051-010-12	133	051-358-14	141	056-473-23	150	062-101-02	160
051-028-13	133	051-358-17	141	056-474-01	150	062-101-03	160
051-029-13	133	051-358-20	141	056-474-02	150	062-101-04	160
051-030-13	134	051-360-18	143	056-477-24	150	062-102-01	160
051-040-13	134	051-360-20	143	056-480-01	150	062-102-02	160
051-048-12	133	051-360-23	143	056-480-02	150	062-102-03	160
051-048-14	133	051-362-18	140	056-481-23	150	062-102-04	160
051-060-15	134	051-364-20	143	056-500-01	151	062-103-01	160
051-060-18	134	051-364-23	143	056-500-02	151	062-103-02	160
051-080-16	135	051-366-17	142	056-500-03	151	062-103-03	160
051-080-18	135	051-366-20	142	056-500-04	151	062-103-04	160
051-080-20	135	051-390-18	144	056-502-22	152	062-111-01	161
051-080-24	135	051-428-14	133	056-503-22	152	062-111-02	161
051-080-26	135	051-560-14	144	056-506-19	152	062-111-03	161
051-080-30	135	051-561-14	144	056-507-19	152	062-111-04	161
051-084-20	139	051-562-14	144	056-508-03	152	062-112-01	161
051-084-24	139	051-563-14	144	056-508-05	152	062-112-02	161
051-090-14	138	051-570-14	144	056-508-07	152	062-112-03	161
051-090-18	138	051-570-18	144	056-510-25	153	062-112-04	161
051-090-20	138	051-571-14	144	056-510-28	153	062-140-01	161
051-090-23	138	051-571-18	144	056-513-15	153	062-140-02	161
051-114-18	136	051-576-14	144	056-513-16	153	062-150-01	162
051-114-20	136	051-576-18	144	056-514-15	153	062-150-02	162
051-114-23	136	051-577-14	144	056-514-16	153	062-150-03	162
051-114-26	136	051-577-18	144	056-516-18	153	062-150-04	162
051-114-31	136	056-211-01	145	056-521-18	153	062-150-05	162
051-114-37	136	056-211-02	145	056-521-27	153	062-150-06	162
051-132-13	136	056-211-03	145	056-530-23	154	062-160-10	162
051-132-15	136	056-211-04	145	056-531-21	154	062-160-20	162
051-132-18	136	056-221-01	145	056-532-23	154	062-162-01	161
051-132-20	136	056-221-02	145	056-550-12	154	062-162-02	161
051-132-23	136	056-221-03	145	056-552-13	154	062-164-01	162
051-132-26	136	056-221-04	145	056-553-14	154	062-164-02	162
051-134-13	137	056-223-01	145	056-555-01	154	062-164-03	162
051-134-15	137	056-223-02	145	056-556-12	154	062-164-04	162
051-134-18	137	056-223-03	145	056-558-00	155	062-166-16	162
051-134-20	137	056-223-04	145	056-558-12	155	062-170-14	163
051-134-23	137	056-320-20	146	056-559-10	155	062-174-15	163
051-134-26	137	056-321-20	146	056-560-01	155	062-178-15	163
051-136-15	137	056-322-20	146	056-560-02	155	062-179-15	163
051-136-17	137	056-323-20	146	056-570-08	155	062-180-16	163
051-136-20	137	056-324-21	147	056-570-11	155	062-181-16	163
051-141-20	135	056-324-27	147	056-570-12	155	062-200-08	164
051-141-24	135	056-325-21	147	056-570-14	155	062-200-10	164
051-141-26	135	056-325-27	147	056-570-16	155	062-200-12	164
051-150-27	138	056-328-20	146	056-570-18	155	062-200-14	164
051-160-27	138	056-329-20	146	056-570-20	155	062-200-16	164
051-185-20	139	056-330-20	146	056-570-22	155	062-200-18	164
051-185-24	139	056-331-20	146	062-050-01	158	062-204-08	164
051-185-26	139	056-332-21	147	062-050-02	158	062-204-10	164
051-211-27	138	056-332-27	147	062-054-15	158	062-204-12	164

062-204-14	164	064-012-06	172	064-272-90	181	070-611-05	188
062-204-16	164	064-012-08	172	064-274-01	181	070-611-07	188
062-204-18	164	064-013-01	172	064-274-02	181	070-620-07	188
062-210-08	165	064-013-02	172	064-274-03	181	070-620-10	188
062-210-10	165	064-013-03	172	064-280-61	180	070-621-07	188
062-210-12	165	064-013-04	172	064-280-62	180	070-621-10	188
062-210-14	165	064-013-06	172	064-280-91	180	070-622-07	188
062-210-16	165	064-013-08	172	064-280-92	180	070-622-10	188
062-210-18	165	064-021-24	173	064-290-38	181	070-630-10	188
062-212-08	165	064-022-24	173	064-290-51	181	070-631-10	188
062-212-10	165	064-032-04	173	064-320-25	182	070-650-10	191
062-212-12	165	064-032-05	173	064-320-26	182	070-651-10	191
062-212-14	165	064-032-06	173	064-320-27	182	070-660-14	189
062-212-16	165	064-032-07	173	064-350-16	183	070-661-14	189
062-212-18	165	064-100-55	173	064-350-25	183	070-670-13	191
062-220-08	166	064-100-60	173	064-350-50	183	070-670-16	191
062-220-11	166	064-100-63	173	064-360-08	183	070-670-20	191
062-220-13	166	064-110-30	174	064-360-10	183	070-671-13	191
062-220-17	166	064-110-31	174	064-360-12	183	070-671-16	191
062-220-20	166	064-110-32	174	064-360-14	183	070-671-20	191
062-220-23	166	064-110-40	174	064-360-16	183	070-672-11	192
062-230-08	166	064-110-50	174	064-360-18	183	070-673-11	192
062-230-11	166	064-120-30	174	064-370-08	184	070-674-15	190
062-230-13	166	064-120-31	174	064-370-10	184	070-684-16	189
062-230-17	166	064-120-32	174	064-370-12	184	070-685-16	189
062-230-20	166	064-120-40	174	064-370-14	184	070-690-31	194
062-230-23	166	064-120-50	174	064-370-16	184	070-691-32	195
062-250-20	166	064-130-22	175	064-370-18	184	070-810-10	190
062-300-12	167	064-130-25	175	064-390-01	182	070-810-13	190
062-302-15	167	064-130-26	175	064-390-02	182	070-810-15	190
062-310-00	167	064-130-35	175	064-390-03	182	070-810-18	190
062-310-01	167	064-130-36	175	064-500-40	182	070-811-10	190
062-310-02	167	064-130-37	175	064-500-62	182	070-811-13	190
062-310-03	167	064-130-40	175	064-600-25	186	070-811-15	190
062-310-04	167	064-130-70	175	064-600-38	186	070-811-18	190
062-340-06	168	064-130-80	175	064-600-50	186	070-822-17	190
062-342-13	168	064-130-85	175	064-600-75	186	070-830-13	192
062-350-00	168	064-140-18	176	064-602-18	184	070-831-13	192
062-360-00	168	064-140-20	176	064-602-22	184	070-840-13	192
062-370-16	169	064-140-25	176	064-602-23	184	070-850-13	193
062-370-20	169	064-140-30	176	064-604-30	185	070-860-20	193
062-370-25	169	064-140-40	176	064-604-33	185	070-860-26	193
062-380-00	168	064-150-44	176	064-604-36	185	070-861-20	193
062-390-00	169	064-150-55	176	064-610-38	185	070-861-26	193
062-396-19	169	064-150-72	176	064-610-50	185	070-870-01	194
064-001-01	170	064-164-20	180	064-610-75	185	070-870-02	194
064-001-02	170	064-180-01	177	064-700-30	186	070-870-03	194
064-001-03	170	064-180-02	177	064-700-32	186	070-870-04	194
064-001-04	170	064-180-03	177	064-710-50	186	070-871-01	194
064-001-06	170	064-182-01	177	064-710-90	186	070-871-02	194
064-001-08	170	064-182-02	177	064-720-01	186	070-871-03	194
064-002-01	171	064-182-03	177	064-720-02	186	070-871-04	194
064-002-02	171	064-192-01	178	064-721-01	186	074-310-01	200
064-002-03	171	064-192-02	178	064-721-02	186	074-310-02	200
064-002-04	171	064-192-03	178	070-202-14	193	074-310-03	200
064-002-06	171	064-200-00	178	070-202-19	193	074-310-28	198
064-002-08	171	064-200-01	178	070-240-10	195	074-312-30	198
064-003-01	170	064-200-02	178	070-240-14	195	074-330-24	199
064-003-02	170	064-220-01	179	070-250-19	193	074-331-01	200
064-003-03	170	064-220-02	179	070-300-16	197	074-331-02	200
064-003-04	170	064-220-03	179	070-300-19	197	074-331-03	200
064-003-06	170	064-230-50	178	070-300-25	197	074-332-24	199
064-003-08	170	064-240-40	178	070-300-32	197	074-334-24	199
064-011-01	171	064-240-50	178	070-301-16	197	074-360-01	200
064-011-02	171	064-240-60	178	070-320-17	198	074-360-02	200
064-011-03	171	064-240-75	178	070-330-18	198	074-360-03	200
064-011-04	171	064-240-85	178	070-330-23	198	074-360-27	199
064-011-06	171	064-250-70	179	070-401-22	196	074-398-01	200
064-011-08	171	064-250-81	179	070-411-17	196	074-398-02	200
064-012-01	172	064-250-82	179	070-420-17	196	074-398-03	200
064-012-02	172	064-250-83	179	070-430-15	196	074-398-10	200
064-012-03	172	064-260-01	180	070-610-05	188	074-398-11	200
064-012-04	172	064-260-02	180	070-610-07	188	074-398-12	200

074-398-13	200	074-910-12	209	080-150-00	217	084-184-55	221
074-399-01	200	074-910-13	209	080-150-01	217	084-190-14	220
074-399-02	200	074-910-14	209	080-150-03	217	085-000-27	222
074-399-03	200	074-915-30	209	080-150-06	217	085-006-24	222
074-399-10	200	074-920-01	209	080-150-09	217	085-007-26	222
074-399-13	200	074-920-02	209	080-150-12	217	085-008-27	222
074-399-14	200	074-920-10	209	080-150-20	217	085-010-17	222
074-399-23	200	074-920-11	209	080-150-21	217	085-010-35	222
074-399-33	200	074-920-12	209	080-150-22	217	085-012-15	223
074-400-10	201	074-920-13	209	080-260-16	216	085-012-25	223
074-412-14	201	074-920-16	209	080-262-18	216	085-012-35	223
074-414-16	201	074-920-20	209	080-264-28	216	085-014-23	222
074-610-00	203	078-170-13	210	080-270-12	216	085-016-22	223
074-760-09	203	078-170-25	210	080-270-14	216	085-020-06	221
074-764-18	202	078-170-32	210	080-270-16	216	085-020-10	221
074-768-20	202	078-170-40	210	080-270-18	216	085-021-06	221
074-768-25	202	078-170-50	210	080-271-12	216	085-021-08	221
074-772-01	202	078-200-01	210	080-271-14	216	085-024-00	222
074-772-02	202	078-200-02	210	080-271-16	216	085-024-01	222
074-772-25	202	078-200-03	210	080-271-18	216	085-024-02	222
074-798-01	203	078-210-06	210	084-100-03	218	085-024-03	222
074-798-02	203	078-210-12	210	084-100-04	218	085-024-04	222
074-798-03	203	078-210-17	210	084-102-03	219	085-030-06	223
074-799-70	203	078-210-20	210	084-102-04	219	085-030-08	223
074-850-18	203	078-210-25	210	084-110-30	218	085-030-10	223
074-850-23	203	078-220-20	210	084-110-35	218	085-030-12	223
074-850-30	203	078-230-28	210	084-110-40	218	085-033-06	223
074-850-45	203	080-000-11	214	084-110-45	218	085-033-08	223
074-859-01	204	080-000-13	214	084-110-50	218	085-033-10	223
074-859-02	204	080-000-14	214	084-110-55	218	085-033-12	223
074-859-03	204	080-000-16	214	084-110-60	218	085-034-06	223
074-859-04	204	080-000-18	214	084-112-30	218	085-034-08	223
074-859-05	204	080-000-20	214	084-112-35	218	085-034-10	223
074-859-06	204	080-004-11	214	084-112-40	218	085-034-12	223
074-859-07	204	080-004-13	214	084-112-45	218	085-050-21	223
074-859-08	204	080-004-14	214	084-112-50	218	085-060-01	223
074-859-09	204	080-004-16	214	084-112-55	218	085-060-02	223
074-860-00	205	080-004-18	214	084-112-60	218	085-060-03	223
074-860-01	205	080-004-20	214	084-114-30	218	085-060-04	223
074-860-11	205	080-013-11	214	084-114-35	218	086-000-01	224
074-860-22	205	080-013-13	214	084-114-40	218	086-000-02	224
074-870-00	205	080-013-14	214	084-114-45	218	086-000-03	224
074-870-01	205	080-013-16	214	084-114-50	218	086-000-04	224
074-870-11	205	080-013-18	214	084-114-55	218	086-000-05	224
074-880-00	206	080-013-20	214	084-114-60	218	086-000-06	224
074-880-01	206	080-027-11	214	084-118-07	218	086-000-07	224
074-880-02	206	080-027-13	214	084-118-09	218	086-060-16	225
074-880-03	206	080-027-14	214	084-118-12	218	086-090-12	226
074-880-11	207	080-027-16	214	084-120-01	220	086-090-14	226
074-880-12	207	080-027-18	214	084-120-02	220	086-090-16	226
074-880-13	206	080-027-20	214	084-120-03	220	086-115-01	226
074-880-14	206	080-033-10	214	084-120-04	220	086-115-02	226
074-880-15	206	080-110-11	215	084-124-24	219	086-115-03	226
074-880-16	206	080-110-13	215	084-128-06	220	086-115-04	226
074-880-17	206	080-110-14	215	084-128-08	220	086-115-05	226
074-880-20	207	080-110-16	215	084-130-20	220	086-115-06	226
074-880-21	207	080-110-18	215	084-130-25	220	086-115-07	226
074-882-00	206	080-110-20	215	084-130-30	220	086-115-08	226
074-882-01	206	080-117-14	214	084-140-01	220	086-117-14	226
074-884-00	207	080-120-16	214	084-140-02	220	086-117-18	226
074-890-01	207	080-122-11	215	084-140-03	220	086-120-01	226
074-890-11	208	080-122-13	215	084-140-04	220	086-120-02	226
074-890-12	208	080-122-14	215	084-160-16	219	086-120-03	226
074-890-13	208	080-122-16	215	084-161-16	219	086-120-04	226
074-890-14	208	080-122-18	215	084-170-00	221	086-120-05	226
074-890-15	208	080-126-20	214	084-172-00	221	086-120-06	226
074-900-00	208	080-130-01	215	084-175-00	221	086-120-07	226
074-900-01	208	080-130-02	215	084-180-30	220	086-130-01	225
074-900-11	208	080-130-03	215	084-180-40	220	086-130-02	225
074-900-12	208	080-130-04	215	084-180-50	220	086-130-03	225
074-900-13	208	080-135-01	256	084-184-30	221	086-130-04	225
074-900-14	208	080-135-02	256	084-184-40	221	086-130-05	225
074-910-11	209	080-135-03	256	084-184-50	221	086-130-06	225

086-140-03	224	140-100-01	211	160-006-24	244	164-231-23	248
086-140-04	224	140-100-02	211	160-010-15	243	164-231-25	248
086-140-05	224	140-100-03	211	160-012-15	243	164-234-22	247
086-140-06	224	140-100-04	211	160-014-20	243	164-234-25	247
086-150-01	224	140-150-01	211	160-020-15	242	164-234-28	247
086-150-14	224	141-001-22	117	160-020-20	242	164-235-22	247
086-180-10	225	141-002-01	118	160-020-23	242	164-235-25	247
086-180-12	225	141-002-02	118	160-030-12	242	164-235-28	247
086-180-15	225	141-003-01	118	160-030-15	242	164-240-24	248
086-200-06	224	141-003-02	118	160-030-19	242	168-010-19	251
086-210-12	225	141-004-20	117	160-040-15	243	168-020-26	251
086-210-15	225	141-005-20	117	160-040-19	243	168-020-28	251
086-650-16	225	154-001-01	232	160-050-20	243	168-108-15	252
086-650-20	225	154-001-02	232	160-070-16	244	168-110-15	252
087-000-01	227	154-005-20	233	160-124-16	242	168-124-25	254
087-000-02	227	154-006-20	233	160-124-20	242	168-124-29	254
087-000-05	227	154-008-20	232	160-124-25	242	168-124-38	254
087-000-10	227	154-009-20	232	160-124-30	242	168-147-00	253
087-000-20	227	154-021-22	232	160-170-18	245	168-147-03	253
087-000-50	227	154-031-01	233	160-170-20	245	168-147-75	253
087-001-01	227	154-031-03	233	160-172-20	245	168-147-95	253
087-001-02	227	154-039-24	233	160-172-23	245	168-150-21	252
087-001-05	227	154-050-01	236	160-178-16	242	168-160-15	252
087-001-10	227	154-050-02	236	160-178-20	242	168-200-00	253
087-001-20	227	154-050-03	236	160-200-18	245	168-212-01	253
087-001-50	227	154-050-04	236	160-201-18	245	168-212-02	253
087-050-01	227	154-050-05	236	160-210-21	245	168-212-03	253
087-050-02	227	154-050-06	236	160-210-23	245	168-212-04	253
087-050-05	227	154-050-07	236	160-211-21	245	168-220-01	254
087-050-10	227	154-050-08	236	160-211-23	245	168-220-02	254
087-050-20	227	154-050-09	236	160-230-21	247	168-220-03	254
087-050-50	227	154-050-10	236	160-230-23	247	168-220-04	254
087-051-01	227	154-050-11	236	160-230-25	247	168-220-05	254
087-051-02	227	154-050-12	236	160-231-21	247	168-220-06	254
087-051-05	227	154-050-13	236	160-231-23	247	168-250-22	254
087-051-10	227	154-056-13	235	160-231-25	247	168-250-30	254
087-051-20	227	154-056-18	235	160-234-22	246	168-268-01	254
087-051-50	227	154-056-21	235	160-234-25	246	168-268-02	254
087-055-02	227	154-058-18	235	160-234-28	246	168-280-01	253
087-055-05	227	154-058-21	235	160-235-22	246	168-280-02	253
087-055-10	227	154-058-24	235	160-235-25	246	168-280-03	253
087-060-01	227	154-058-27	235	160-235-28	246	168-280-04	253
087-060-02	227	154-070-01	234	160-240-24	248	168-280-05	253
087-061-01	227	154-072-01	234	160-253-23	248	168-300-28	255
087-061-02	227	154-074-01	234	160-259-23	248	168-300-35	255
087-065-01	228	154-074-02	234	160-310-15	249	168-300-42	255
087-066-01	228	154-076-34	234	160-310-21	249	168-301-28	255
087-070-05	228	154-078-32	235	160-310-29	249	168-301-35	255
087-070-10	228	154-080-01	234	160-311-15	249	168-301-42	255
087-070-15	228	154-080-02	234	160-311-21	249	168-311-28	255
087-070-20	228	154-080-03	234	160-311-29	249	168-311-35	255
087-071-05	228	154-080-04	234	160-320-05	249	168-311-42	255
087-071-10	228	154-080-05	234	160-320-07	249	168-312-28	255
087-071-15	228	154-080-06	234	160-320-10	249	168-312-35	255
087-071-20	228	154-080-07	234	160-325-26	249	168-312-42	255
087-080-10	228	154-080-08	234	160-340-08	249	168-400-00	255
087-080-20	228	154-082-35	235	160-360-30	250	168-410-00	255
087-080-30	228	158-001-01	232	160-361-30	250	168-471-19	256
087-080-50	228	158-001-02	232	160-364-33	250	168-473-19	256
087-081-10	228	158-001-03	232	160-365-33	250	170-055-01	117
087-081-20	228	158-001-04	232	161-006-16	244	170-055-02	117
087-081-30	228	158-001-05	232	161-006-20	244	170-071-24	238
087-081-50	228	158-001-06	232	161-170-20	244	170-073-23	238
087-911-00	229	158-519-23	116	164-006-16	244	170-075-23	238
087-912-06	229	158-519-24	116	164-006-20	244	170-077-24	238
087-912-08	229	160-000-12	242	164-210-21	246	170-080-20	238
087-913-00	229	160-000-15	242	164-210-23	246	170-080-28	238
087-920-00	229	160-004-15	242	164-211-21	246	170-150-28	238
087-922-00	229	160-004-19	242	164-211-23	246	170-160-00	237
087-926-00	229	160-004-25	242	164-230-21	248	170-172-00	237
087-930-02	229	160-006-16	244	164-230-23	248	170-176-00	237
087-935-00	229	160-006-18	244	164-230-25	248	170-176-01	237
087-939-00	229	160-006-20	244	164-231-21	248	170-176-02	237

170-176-03	237	180-146-01	259	180-270-01	265	180-350-25	270
170-176-04	237	180-146-02	259	180-270-02	265	180-350-26	270
170-182-00	237	180-146-03	259	180-271-01	265	180-350-98	270
170-230-21	239	180-150-01	260	180-271-02	265	180-350-99	270
170-236-22	239	180-150-02	260	180-272-01	265	180-351-01	270
170-238-21	239	180-150-03	260	180-272-02	265	180-351-02	270
170-240-22	239	180-160-00	260	180-275-17	265	180-351-03	270
170-250-26	239	180-170-00	261	180-290-01	265	180-351-04	270
170-257-23	239	180-172-00	261	180-290-02	265	180-351-05	270
170-345-08	240	180-180-00	261	180-290-03	265	180-351-06	270
170-349-11	240	180-180-03	261	180-290-17	265	180-351-07	270
170-350-08	240	180-180-04	261	180-292-01	266	180-351-08	270
170-350-11	240	180-180-05	261	180-292-02	266	180-351-09	270
170-350-13	240	180-180-06	261	180-292-03	266	180-351-10	270
170-350-16	240	180-180-07	261	180-292-04	266	180-351-11	270
170-350-21	240	180-180-08	261	180-294-01	267	180-351-12	270
170-350-26	240	180-180-40	261	180-294-02	267	180-351-13	270
170-350-32	240	180-180-80	261	180-294-03	267	180-351-14	270
170-360-00	240	180-220-01	262	180-300-01	267	180-351-15	270
170-650-08	240	180-220-02	262	180-300-02	267	180-351-16	270
170-650-10	240	180-220-03	262	180-301-01	267	180-351-17	270
170-650-12	240	180-221-01	262	180-301-02	267	180-354-01	271
170-650-14	240	180-221-02	262	180-305-01	267	180-354-03	271
170-650-16	240	180-221-03	262	180-305-02	267	180-354-05	271
170-650-18	240	180-222-01	262	180-307-20	268	180-354-07	271
170-650-20	240	180-222-02	262	180-307-25	268	180-354-09	271
170-650-22	240	180-222-03	262	180-307-30	268	180-354-11	271
170-650-24	240	180-230-01	262	180-307-35	268	180-354-13	271
170-660-06	240	180-230-03	262	180-307-40	268	180-354-15	271
170-660-07	240	180-231-01	262	180-308-20	268	180-354-17	271
170-660-08	240	180-231-02	262	180-308-25	268	180-354-19	271
170-660-09	240	180-231-03	262	180-308-30	268	180-354-21	271
170-660-10	240	180-232-01	262	180-308-35	268	180-354-23	271
170-660-11	240	180-232-02	262	180-308-40	268	180-354-25	271
170-660-12	240	180-232-03	262	180-309-40	268	180-354-98	271
170-660-13	240	180-234-00	263	180-310-20	268	180-354-99	271
170-660-14	240	180-234-01	263	180-311-10	268	180-360-05	271
170-660-15	240	180-234-02	263	180-311-20	268	180-360-06	271
170-660-16	240	180-234-03	263	180-311-25	268	180-360-07	271
170-660-18	240	180-235-00	263	180-312-15	268	180-360-08	271
170-660-20	240	180-235-01	263	180-312-20	268	180-360-09	271
170-660-24	240	180-235-02	263	180-312-25	268	180-360-10	271
180-090-03	269	180-235-03	263	180-312-30	268	180-360-98	271
180-090-04	269	180-236-00	263	180-312-35	268	180-370-05	272
180-090-05	269	180-236-01	263	180-312-40	268	180-370-06	272
180-092-03	269	180-236-02	263	180-313-19	268	180-370-08	272
180-092-04	269	180-236-03	263	180-315-23	268	180-370-09	272
180-092-05	269	180-237-01	263	180-315-25	268	180-370-10	272
180-096-25	269	180-237-02	263	180-317-30	268	180-370-12	272
180-100-01	260	180-238-01	263	180-350-01	270	180-370-13	272
180-100-02	260	180-238-02	263	180-350-02	270	180-370-14	272
180-100-03	260	180-239-01	263	180-350-03	270	180-370-98	272
180-120-01	260	180-239-02	263	180-350-04	270	180-400-25	273
180-120-02	260	180-260-01	264	180-350-05	270	180-402-26	273
180-120-03	260	180-260-02	264	180-350-06	270	180-404-25	273
180-130-01	258	180-260-03	264	180-350-07	270	180-410-18	272
180-130-02	258	180-261-01	264	180-350-08	270	180-412-19	272
180-130-03	258	180-261-02	264	180-350-09	270	180-414-17	272
180-132-00	258	180-261-03	264	180-350-10	270	180-417-20	273
180-134-00	258	180-261-04	264	180-350-11	270	180-419-28	273
180-140-00	259	180-262-01	264	180-350-12	270	180-421-24	273
180-140-01	259	180-262-02	264	180-350-13	270	180-423-24	274
180-140-02	259	180-262-03	264	180-350-14	270	180-426-24	274
180-140-03	259	180-262-04	264	180-350-15	270	180-429-24	274
180-142-01	258	180-264-01	264	180-350-16	270	180-431-23	274
180-142-02	258	180-264-02	264	180-350-17	270	180-434-21	274
180-142-03	258	180-264-03	264	180-350-18	270	180-435-21	274
180-142-04	258	180-265-01	264	180-350-19	270	180-440-06	275
180-142-05	258	180-265-02	264	180-350-20	270	180-440-08	275
180-142-06	258	180-265-03	264	180-350-21	270	180-440-10	275
180-144-01	259	180-266-01	264	180-350-22	270	180-441-06	275
180-144-02	259	180-266-02	264	180-350-23	270	180-441-08	275
180-144-03	259	180-266-03	264	180-350-24	270	180-441-10	275

180-442-15	275	180-700-20	280	180-712-05	283	181-600-34	292
180-444-20	275	180-700-21	280	180-712-06	283	186-000-14	295
180-446-28	275	180-700-23	280	180-712-07	283	186-002-14	295
180-449-26	275	180-701-05	280	180-712-08	283	186-010-10	295
180-470-20	276	180-701-06	280	180-712-09	283	186-012-14	295
180-472-27	276	180-701-07	280	180-712-11	283	186-020-10	295
180-475-32	276	180-701-08	280	180-712-12	283	186-100-03	295
180-480-25	276	180-701-09	280	180-712-14	283	186-100-04	295
180-482-27	276	180-701-11	280	180-712-15	283	186-100-05	295
180-485-23	276	180-701-12	280	180-712-16	283	186-100-06	295
180-488-25	277	180-701-14	280	180-712-19	283	186-110-03	294
180-500-26	277	180-701-15	280	180-712-20	283	186-110-04	294
180-502-28	277	180-701-16	280	180-712-21	283	186-110-05	294
180-510-32	277	180-701-19	280	180-712-23	283	186-200-02	294
180-511-32	277	180-701-20	280	180-713-05	283	186-200-03	294
180-516-32	277	180-701-21	280	180-713-06	283	186-200-04	294
180-518-32	277	180-701-23	280	180-713-07	283	186-200-05	294
180-521-25	277	180-702-05	281	180-713-08	283	186-200-06	294
180-527-29	277	180-702-06	281	180-713-09	283	186-200-07	294
180-529-28	277	180-702-07	281	180-713-11	283	186-200-08	294
180-530-00	269	180-702-08	281	180-713-12	283	186-210-00	294
180-530-01	269	180-702-09	281	180-713-14	283	186-400-00	294
180-530-02	269	180-702-11	281	180-713-15	283	186-400-01	294
180-540-30	278	180-702-12	281	180-713-16	283	186-400-02	294
180-542-30	278	180-702-14	281	180-713-19	283	186-400-03	294
180-543-30	278	180-702-15	281	180-713-20	283	186-420-01	296
180-550-04	278	180-702-16	281	180-713-21	283	186-420-17	296
180-552-04	278	180-702-19	281	180-713-23	283	186-430-01	296
180-560-04	278	180-702-20	281	180-720-30	284	186-430-16	296
180-560-06	278	180-702-21	281	180-720-35	284	186-500-13	296
180-560-09	278	180-702-23	281	180-720-40	284	186-510-13	296
180-570-25	279	180-703-05	281	180-721-30	284	186-600-13	296
180-572-25	279	180-703-06	281	180-721-35	284	186-610-01	296
180-574-22	279	180-703-07	281	180-721-40	284	186-610-02	296
180-576-01	279	180-703-08	281	180-722-30	285	191-132-20	306
180-576-02	279	180-703-09	281	180-722-35	285	191-145-18	306
180-576-03	279	180-703-11	281	180-722-40	285	191-201-24	306
180-576-04	279	180-703-12	281	180-723-30	285	192-406-00	300
180-576-05	279	180-703-14	281	180-723-35	285	192-406-01	300
180-580-27	279	180-703-15	281	180-723-40	285	192-406-02	300
180-588-01	279	180-703-16	281	180-760-01	286	192-408-00	300
180-588-02	279	180-703-19	281	180-760-02	286	192-408-01	300
180-602-25	287	180-703-20	281	180-760-03	286	192-408-12	300
180-604-20	287	180-703-21	281	180-760-04	286	192-410-16	300
180-608-28	287	180-703-23	281	180-760-05	286	192-411-15	300
180-610-04	287	180-710-05	282	180-760-06	286	192-414-13	300
180-610-06	287	180-710-06	282	181-034-30	289	192-414-14	300
180-614-23	287	180-710-07	282	181-036-33	289	192-414-17	300
180-615-23	287	180-710-08	282	181-036-36	289	192-430-11	300
180-630-10	288	180-710-09	282	181-044-36	290	192-430-12	300
180-630-12	288	180-710-11	282	181-046-36	289	192-448-00	299
180-630-14	288	180-710-12	282	181-052-41	290	192-448-01	299
180-630-40	288	180-710-14	282	181-054-40	290	192-448-02	299
180-630-41	288	180-710-15	282	181-056-28	289	192-448-03	299
180-630-50	288	180-710-16	282	181-058-30	289	192-448-04	299
180-680-24	286	180-710-19	282	181-058-36	289	192-452-01	299
180-682-21	286	180-710-20	282	181-058-38	289	192-452-02	299
180-682-29	286	180-710-21	282	181-060-44	290	192-452-11	299
180-684-24	286	180-710-23	282	181-080-32	290	192-467-01	298
180-686-24	287	180-711-05	282	181-080-38	290	192-467-02	298
180-688-21	287	180-711-06	282	181-084-36	290	192-467-03	298
180-690-26	287	180-711-07	282	181-084-40	290	192-467-11	298
180-700-05	280	180-711-08	282	181-200-21	291	192-467-12	298
180-700-06	280	180-711-09	282	181-244-01	291	192-467-13	298
180-700-07	280	180-711-11	282	181-244-02	291	192-467-14	298
180-700-08	280	180-711-12	282	181-244-03	291	192-469-01	298
180-700-09	280	180-711-14	282	181-245-01	291	192-469-02	298
180-700-11	280	180-711-15	282	181-245-02	291	192-469-03	298
180-700-12	280	180-711-16	282	181-245-03	291	192-469-04	298
180-700-14	280	180-711-19	282	181-252-30	291	192-469-11	298
180-700-15	280	180-711-20	282	181-260-27	291	192-469-12	298
180-700-16	280	180-711-21	282	181-261-27	291	192-469-13	298
180-700-19	280	180-711-23	282	181-300-42	292	192-469-14	298

192-469-15	298	194-336-04	304	250-140-27	309
192-469-16	298	194-336-05	304	250-142-06	309
192-472-01	298	194-336-06	304	250-142-07	309
192-472-02	298	194-350-06	305	250-142-08	309
192-472-03	298	194-350-09	305	250-142-09	309
192-472-04	298	194-350-13	305	250-151-14	308
192-472-11	298	194-350-16	305	250-154-12	308
192-472-12	298	194-350-19	305	250-160-20	308
192-472-13	298	194-350-25	305	250-163-27	308
192-472-14	298	194-350-32	305	250-164-23	308
192-472-15	298	194-351-06	305	250-166-35	308
192-472-16	298	194-351-09	305	250-200-01	310
192-487-01	299	194-351-13	305	250-200-02	310
192-487-02	299	194-351-16	305	250-200-03	310
192-487-11	299	194-351-19	305	250-200-04	310
192-487-12	299	194-351-25	305	250-200-05	310
193-440-19	301	194-351-32	305	250-200-06	310
193-465-01	302	194-352-09	306	250-200-07	310
193-465-02	302	194-352-14	306	250-200-08	310
193-465-03	302	194-352-16	306	250-200-09	310
193-465-04	302	194-352-19	306	250-300-00	310
193-472-19	303	194-352-25	306	250-300-01	310
193-476-15	302	194-353-09	306	250-310-50	310
193-477-10	302	194-353-14	306	250-800-01	311
193-477-15	302	194-353-16	306	250-800-02	311
193-477-20	302	194-353-19	306	250-800-10	311
193-477-25	302	194-353-25	306		
193-478-15	302	194-360-10	305		
193-479-15	303	194-360-12	305		
193-480-04	303	194-360-15	305		
193-480-06	303	194-360-25	305		
193-480-08	303	194-361-10	304		
193-481-17	303	194-361-15	304		
193-485-17	303	194-361-20	304		
193-487-17	303	194-361-25	304		
193-488-21	303	194-362-10	305		
193-501-17	301	194-362-12	305		
193-512-16	301	194-362-15	305		
193-512-17	301	194-362-25	305		
193-520-08	301	194-450-06	306		
193-520-10	301	194-450-15	306		
194-300-08	304	194-450-20	306		
194-300-10	304	194-450-25	306		
194-300-12	340	194-450-30	306		
194-300-14	304	194-450-38	306		
194-300-16	304	194-450-44	306		
194-301-08	304	194-450-50	306		
194-301-10	304	194-451-06	306		
194-301-12	304	194-451-15	306		
194-301-14	304	194-451-20	306		
194-301-16	304	194-451-25	306		
194-302-08	304	194-451-30	306		
194-302-10	304	194-451-38	306		
194-302-12	304	194-451-44	306		
194-302-14	304	194-451-50	306		
194-302-16	304	250-130-04	309		
194-318-04	305	250-130-06	309		
194-318-06	305	250-130-08	309		
194-318-08	305	250-130-10	309		
194-318-10	305	250-130-12	309		
194-318-12	305	250-130-15	309		
194-318-14	305	250-133-00	309		
194-319-04	305	250-133-10	309		
194-319-06	305	250-133-20	309		
194-319-08	305	250-133-30	309		
194-319-10	305	250-133-40	309		
194-319-12	305	250-133-50	309		
194-319-14	305	250-133-60	309		
194-334-03	304	250-133-70	309		
194-334-04	304	250-133-80	309		
194-334-05	304	250-133-90	309		
194-334-06	304	250-140-17	309		
194-336-03	304	250-140-25	309		

ADAIR, UTERINE TENACULUM FORCEPS, 19,0 CM	272	BABY-MIXTER DISS.FCPS STR.CVD 14,0 CM	99
ADLERKREUTZ TISSUE FCPS 2 X 3, 15,0 CM	72	BABY-OVERHOLT ART.FORCEPS CVD 13,5 CM	102
ADLERKREUTZ TISSUE FCPS 2 X 3, 20,0 CM	72	BABY-ROUX, RETRACTOR, 13,0 CM	168
ADLERKREUTZ TISSUE FCPS 4 X 5, 15,0 CM	72	BABY-SENN-MILLER RETRACTOR BLOUNT 15,0CM	163
ADLERKREUTZ TISSUE FCPS 4 X 5, 20,0 CM	72	BABY-SENN-MILLER RETRACTOR SHARP 15,0 CM	163
ADSON (CONE) RETRACTOR BLUNT 20,0 CM	193	BABY-TISCHLER FCPS 20 CM WITH FS ROUND CUT	288
ADSON (CONE) RETRACTOR BLUNT 26,0 CM	193	BACKHAUS TOWEL FORCEPS 11,0 CM	86
ADSON (CONE) RETRACTOR SHARP 20,0 CM	193	BACKHAUS TOWEL FORCEPS 13,0 CM	86
ADSON (CONE) RETRACTOR SHARP 26,0 CM	193	BACKHAUS TOWEL FORCEPS 15,0 CM	86
ADSON DRESSING FORCEPS 12,0 CM	66	BACKHAUS TOWEL FORCEPS 8,0 CM	86
ADSON DRESSING FORCEPS 15,0 CM	66	BAINBRIDGE ARTERY FORCEPS CVD 15,0 CM	105
ADSON FCPS WITH TC 12,0 CM	83	BAINBRIDGE ARTERY FORCEPS CVD 18,5 CM	105
ADSON FCPS WITH TC 15,0 CM	83	BAINBRIDGE ARTERY FORCEPS STR 15,0 CM	105
ADSON FORCEPS TC 1X2 TEETH 12,0 CM	83	BAINBRIDGE ARTERY FORCEPS STR 18,5 CM	105
ADSON FORCEPS TC 1X2 TEETH 15,0 CM	83	BAKES GALL DUCT DILATOR ELASTIC, Ø 9,0 MM, 30,0 CM	236
ADSON NEEDLE HOLDER 18,0 CM	125	BAKES GALL DUCT DILATOR FIG.8 30,0 CM ELASTIC, Ø 8,0 MM, 30,0 CM	236
ADSON TISSUE FCPS 1X2 TEETH 15,0 CM	71	BAKES GALL DUCT DILATOR, ELASTIC, Ø 10,0 MM, 30,0 CM	236
ADSON TISSUE FCPS 1X2 TEETH, SERRATED, 12,0 CM	72	BAKES GALL DUCT DILATOR, ELASTIC, Ø 13,0 MM, 30,0 CM	236
ADSON, RASPARTORY, FIG. 1, 8 MM, STRAIGHT, 17,0 CM	302	BAKES, GALL DUCT DILATOR ELASTIC, Ø 4,0 MM, 30,0 CM	236
ADSON, RASPARTORY, FIG. 2, 7 MM, CURVED, 17,0 CM	302	BAKES, GALL DUCT DILATOR ELASTIC, Ø 1,0 MM, 30,0 CM	236
ADSON, RASPARTORY, FIG. 3, 7 MM, STRAIGHT, 17,0 CM	302	BAKES, GALL DUCT DILATOR ELASTIC, Ø 11,0 MM, 30,0 CM	236
ADSON, RASPARTORY, FIG. 4, 7 MM, STRONG CURVED, 17,0 CM	302	BAKES, GALL DUCT DILATOR ELASTIC, Ø 12,0 MM, 30,0 CM	236
ADSON, SUCTION TUBE Ø 4,0 MM, 21,0 CM, LUER ATTACHMENT CURVED	223	BAKES, GALL DUCT DILATOR ELASTIC, Ø 2,0 MM, 30,0 CM	236
ADSON, TISSUE FORCEPS 1 X 2 TEETH, 12,0 CM	71	BAKES, GALL DUCT DILATOR ELASTIC, Ø 3,0 MM, 30,0 CM	236
ADSON-BABY, SELF-RETAINING RETRACTOR, BLUNT, 3x4 PRONGS, 16,0 CM	189	BAKES, GALL DUCT DILATOR ELASTIC, Ø 5,0 MM, 30,0 CM	236
ADSON-BABY, SELF-RETAINING RETRACTOR, SHARP, 3x4 PRONGS, 16,0 CM	189	BAKES, GALL DUCT DILATOR ELASTIC, Ø 6,0 MM, 30,0 CM	236
ADSON-BROWN TISS. FCPS STR 7X7 T.12,0 CM	72	BAKES, GALL DUCT DILATOR ELASTIC, Ø 7,0 MM, 30,0 CM	236
ADSON-BROWN TISS. FCPS STR 7X7 T.15,0 CM	72	BALFOUR ABDOMINAL RETRACTOR US-TYPE, 250 MM OPENING	202
ADVENTITIA MICRO SCISSORS SH/SH 14,5 CM	61	BALFOUR EXCHANGEABLE BLADE 100X35 MM	202
ADVENTITIA MICRO SCISSORS SH/SH 15,0 CM	61	BALFOUR EXCHANGEABLE BLADE 45X80 MM	203
ADVENTITIA MICRO SCISSORS SH/SH 18,0 CM	61	BALFOUR EXCHANGEABLE BLADE 70X35 MM	202
ADVENTITIA MICRO SCISSORS SH/SH, SERRATED, 15,0 CM	61	BALFOUR EXCHANGEABLE BLADE 70X85 MM	203
ALAN PARKS ANAL RETRACTOR COMPLETE	253	BALFOUR, ABDOMINAL RETRACTOR, 180 MM, OPENING	202
ALAN PARKS, ANAL RETRACTOR, VALVE 25 X 95 MM	253	BALFOUR, ABDOMINAL RETRACTOR, 200 MM, OPENING	202
ALEXANDER CERV.BIOPSY+SPEC.FCPS 28,0 CM	287	BALFOUR, ABDOMINAL RETRACTOR, 250 MM, OPENING	202
ALEXANDER CHISEL 10MM 18,0CM	305	BALFOUR, EXCHANGEABLE BLADE, 80x90 MM	203
ALEXANDER CHISEL 12MM 18,0CM	305	BALFOUR-BABY ABDOM.RETRACTOR 90MM OPENIN	203
ALEXANDER CHISEL 14MM 18,0CM	305	BARRAQUER, MICRO-NEEDLE HOLDER, STRAIGHT, SERRATED, WITH TC, 14,5 CM	144
ALEXANDER CHISEL 4MM 18,0CM	305	BARRAQUER, MICRO-NEEDLE HOLDER, STRAIGHT, SMOOTH, WITH TC, 14,5 CM	144
ALEXANDER CHISEL 6MM 18,0CM	305	BARRAQUER, MICRO-NEEDLE HOLDER, CURVED, SERRATED, WITH TC, 14,5 CM	144
ALEXANDER CHISEL 8MM 18,0CM	305	BARRAQUER, MICRO-NEEDLE HOLDER, CURVED, SMOOTH, WITH TC, 14,5 CM	144
ALEXANDER, GOUGE, 10MM 18,0CM	305	BARRAQUER, MICRO-NEEDLE HOLDER, W. RATCHET, CURVED, 13,0 CM	130
ALEXANDER, GOUGE, 12MM 18,0CM	305	BARRAQUER-TROUTMAN, MICRO-NEEDLE HOLDER, CURVED, 10,0 CM	130
ALEXANDER, GOUGE, 14MM 18,0CM	305	BARRAQUER-TROUTMAN, MICRO-NEEDLE HOLDER, STRAIGHT, 10,0 CM	130
ALEXANDER, GOUGE, 4MM 18,0CM	305	BARRETT, UTERINE TENACULUM FORCEPS, 18,0CM	272
ALEXANDER, GOUGE, 6MM 18,0CM	305	BARRY STERNAL, WIRE TWISTING FORCEPS WITH TC-INSERTS, 15,0 CM	139
ALEXANDER, GOUGE, 8MM 18,0CM	305	BEACHAM AMNIOTOME 26,0CM	277
ALLEN, INTESTINAL CLAMP, 15,5 CM	242	BECKAMNN-ADSON RETRACTOR SHARP 31,0 CM	194
ALLEN, INTESTINAL CLAMP, 20,0 CM	242	BECKMANN, SELF-RETAINING RETRACTOR 4 X 4 PRONGS, SHARP, 31,0 CM	194
ALLEN, INTESTINAL CLAMP, 23,0 CM	242	BECKMANN, SELF-RETAINING RETRACTOR 4 X 5 PRONGS, BLUNT, 33,0 CM	195
ALLIS AT TISSUE FORCEPS 16,0 CM	242	BECKMANN-ADSON RETRACTOR 25X31MM, BLUNT, 31,0CM	194
ALLIS AT TISSUE SEIZING FCPS, 20,0 CM	242	BECKMANN-ADSON RETRACTOR 25X40 MM, BLUNT, 31,0 CM	194
ALLIS TISSUE FORCEPS 25,0 CM	242	BECKMANN-ADSON RETRACTOR SHARP 31,0 CM	194
ALLIS, INTESTINAL AND TISSUE GRASPING FORCEPS, 4X5T 15,0CM	242	BECKMANN-ADSON, SELF-RETAINING RETRACTOR 25 X 25 MM, SHARP, 31,0 CM	194
ALLIS, INTESTINAL AND TISSUE GRASPING FORCEPS, 5X6 TEETH, 19,0CM	242	BECKMANN-ADSON, SELF-RETAINING RETRACTOR 25 X 45 MM, SHARP, 31,0 CM	194
ALLIS, INTESTINAL AND TISSUE GRASPING FORCEPS, 5X6T 15,0CM	242	BECKMANN-ADSON, SELF-RETAINING RETRACTOR 25X25 MM, BLUNT, 31,0 CM	194
ALLIS, INTESTINAL AND TISSUE GRASPING FORCEPS, 5X6T 25,0CM	242	BECKMANN-ADSON, SELF-RETAINING RETRACTOR 25X45 MM, BLUNT, 31,0 CM	194
ALLIS, INTESTINAL GRASPING FORCEPS, 20,0 CM	243	BENGOLEA ARTERY FCPS CVD, 1X2T, 26,0 CM	106
ALLIS, TISSUE SEIZING FORCEPS 5 X 6 TEETH, 30,0 CM	242	BENGOLEA ARTERY FCPS STR 1X2T, 26,0 CM	106
ALLIS-ADAIR TIS. SEIZ.FCPS. 10X11 15,0 CM	243	BENGOLEA ARTERY FCPS STR. 1X2T, 20,0 CM	106
ALLIS-BABY, INTESTINAL AND TISSUE GRASPING FORCEPS, 4X5 T., 12,5 CM	242	BENGOLEA ARTERY FCPS, CVD, 1X2T, 20,0 CM	106
ALLISON, LUNG SPATULA, 40 MM, 30,0 CM	186	BENGOLEA ARTERY FORCEPS CURVED 26,0 CM	106
ALLISON, LUNG SPATULA, 54 MM, 32,0 CM	186	BENGOLEA ARTERY FORCEPS STRAIGHT 20,0 CM	106
ALM RETRACTOR BLUNT 4X4 PRONGS 10,0 CM	188	BENGOLEA ARTERY FORCEPS STRAIGHT 26,0 CM	106
ALM RETRACTOR BLUNT 4X4 PRONGS 7,0 CM	188	BENGOLEA ARTERY FORCEPS STRAIGHT 20,0 CM	106
ALM RETRACTOR SHARP 4X4 PRONGS 10,0 CM	188	BENGOLEA ARTERY FORCEPS STRAIGHT 26,0 CM	106
ALM RETRACTOR SHARP 4X4 PRONGS 7,0 CM	188	BENGOLEA ARTERY FORCEPS CURVED 20,0 CM	106
ALM, RETRACTOR, SEMI-SHARP, 4x4 PRONGS, 10,0 CM	188	BERGMANN MALLETS, 300G, 24,0 CM	306
ALM, RETRACTOR, SEMI-SHARP, 4x4 PRONGS, 7,0 CM	188	BERGMANN PLASTER OF PARIS SHEARS 23,0 CM	44
ANDREW-PINCHON SUCTION TUBE, 24,0 CM	222	BERKELEY, ABDOMINAL RETRACTOR, COMPLETE	203
ANTHONY, SUCTION TUBE, 26,0 CM	222	BERLIN, TUBING CLAMP, 14,5 CM	91
AUVARD VAG.SPECULA 105 X 38MM	261	BERNHARD TOWEL FORCEPS 16,5 CM	87
AUVARD, VAGINAL SPECULA, W. REMOVABLE WEIGHT, 75 X 38 MM	261	BIER, LUMBAR PUNCTURE NEEDLE, Ø 1,6 x 90 MM	225
BABCOCK AT INT.TISSUE FORCEPS 16,0 CM	244	BIER, LUMBAR PUNCTURE NEEDLE, Ø 1,8 x 90 MM	225
BABCOCK AT INT.TISSUE FORCEPS 20,0 CM	244	BIER, LUMBAR PUNCTURE NEEDLE, Ø 2,1 x 90 MM	225
BABCOCK INT.TISS.FCPS TC 16,0 CM	244	BIER, LUMBAR PUNCTURE NEEDLE, Ø 2,4 x 90 MM	225
BABCOCK INT.TISS.FCPS TC 20,0 CM	244	BIER, LUMBAR PUNCTURE NEEDLE, Ø 2,8 x 90 MM	225
BABCOCK INT.TISSUE FCPS 16,0 CM	244	BIER, LUMBAR PUNCTURE NEEDLE, Ø 3,0 x 90 MM	225
BABCOCK INT.TISSUE FCPS 18,0 CM	244	BIRKETT DISS.AND LIG.FCPS. CVD 19,0 CM	103
BABCOCK INT.TISSUE FCPS 24,0 CM	244	BIRKETT DISS.AND LIG.FCPS. STR 19,0 CM	103
BABCOCK TISSUE FCPS 20,0 CM	244	BLADE 23X44 MM	198
BABY-ADSON ART.FCPS CVD 14,0 CM	108	BLADES ONLY, PAIR, FOR ALAN PARKS	253
BABY-ADSON ART.FCPS CVD 18,0 CM	108	BLADES ONLY, PAIR, FOR ALAN PARKS 22 X 95 MM	253
BABY-DOYEN INT.CLAMP FCPS. CVD.18,0 CM	245	BLAKE GALL STONE FORCEPS CVD 20,0 CM	233
BABY-DOYEN INT.CLAMPS FCPS. STR.18,0 CM	245	BLAKE GALL STONE FORCEPS STR 20,0 CM	233
BABY-METZENBAUM, DISSEC.-SCS., SUPERCUT, STRAIGHT, BL/BL, 11,0 CM	57	BOETTCHER TONSIL SCISSORS CVD 18,0 CM	83
BABY-METZENBAUM, DISSEC.-SCS., SUPERCUT, STRAIGHT, BL/BL, 14,5 CM	57	BONNEY TISSUE FORCEPS 1X2 T. TC 18,0 CM	36
BABY-MIKULICZ PERIT.CLAMP-FCPS 14,0 CM	118	BONNEY TISSUE FORCEPS 1X2 TEETH 18,0 CM	76
BABY-MIXTER ART.FCPS CVD 18,0 CM	108	BONNEY TISSUE FORCEPS 2X3 TEETH 18,0 CM	76
BABY-MIXTER DISS.FCPS SL.CVD 14,0 CM	99	BONNEY, DRESSING FORCEPS, 18,0 CM	68
		BOYS-ALLIS INT.TISS.FCPS 5X6 T. 15,0 CM	243

BOZEMANN DRESSING FCPS S-SHAPED 26.0 CM	89	BUMM, UTERINE CURETTE, SHARP, RIGID, FIG. 2, Ø 35 MM, 31,0 CM	284
BOZEMANN DRESSING FCPS STRAIGHT 26.0 CM	88	BUMM, UTERINE CURETTE, SHARP, RIGID, FIG. 3, Ø 40 MM, 31,0 CM	284
BOZEMANN LOOP TWISTER 21.0 CM	154	BUNT, SAFETY PIN, 12,0 CM	308
BOZEMANN NEEDLE HOLDER TC S CVD 26.0 CM	139	BURKE FORCEPS, 22,0CM	288
BOZEMANN NEEDLE HOLDER TC S-CVD 20.0 CM	139	BUSCH UMBILICAL SCISSORS 13.0 CM	43
BOZEMANN NEEDLE HOLDER TC S-CVD 24.0 CM	139	BUSCH UMBILICAL SCISSORS 16.0 CM	43
BOZEMANN, GYN.-SCS, S-SHAPED, BL/BL, 22.0 CM	40	BYRD SUCTION TUBE 15 CM 2.5MM	223
BRAITHWAITE, DERMATOMES, SPARE BLADE ONLY	11	BYRD SUCTION TUBE 15.0CM 1.5MM	223
BRAITHWAITE, DERMATOMES, 30.0 CM	11	BYRD SUTION TUBE 15 CM 3.5 MM	223
BRAUN MODIF., VAGINAL SPECULA, 85X17 MM	268	CAMPBELL TROCER 16.0 CM 6 MM	220
BRAUN, UTERINE DEPRESSOR, 28.0 CM	277	CAMPBELL TROCER 16.0 CM 8 MM	220
BRAUN, UTERINE TENACULUM FORCEPS, 4X4 TEETH, 15,5 CM	275	CANNULA FOR VAGINAL ANEASTHESIA, Ø 1,0 x 185 MM	224
BRAUN, UTERINE TENACULUM FORCEPS, 25,0 CM	273	CANNULA, Ø 1,2 x 80 MM	225
BRAUN-STADLER EPISIOTOMY SCS 22.0 CM	43	CANNULA, Ø 1,5 x 80 MM	225
BRAUN-STADLER EPISIOTOMY SCS 14.0 CM	43	CANNY RYAL, RETRACTOR, 16 MM, 19,0 CM	169
BREISKY VAG.SPEC.BAYONET SH.100X20 MM	268	CANNY RYAL, RETRACTOR, 20 MM, 19,0 CM	169
BREISKY VAG.SPEC.BAYONET SH.100X25 MM	268	CANNY RYAL, RETRACTOR, 25 MM, 20,0 CM	169
BREISKY VAG.SPEC.BAYONET SH.100X30 MM	268	CAPLAN NASAL SCISSORS CURVED 22.0 CM	35
BREISKY VAG.SPEC.BAYONET SH.100X35 MM	268	CARREL ARTERY FORCEPS STR 10.0 CM	98
BREISKY VAG.SPEC.BAYONET SH.100X40 MM	268	CARTILAGE SCISS.SAW EDGE 20.0 CM	36
BREISKY VAG.SPEC.BAYONET SH.130X20 MM	268	CARTILAGE, RESECTION KNIVES, WITH DISSECTOR END, 17.5 CM	10
BREISKY VAG.SPEC.BAYONET SH.130X25 MM	268	CASTROVIEJO, MICRO-NEEDLEHOLDER, W. RATCHET, SERRATED, CURVED, 14,5 CM	131
BREISKY VAG.SPEC.BAYONET SH.130X30 MM	268	CASTROVIEJO, MICRO-NEEDLEHOLDER, W. RATCHET, SERRATED, STRAIGHT, 14,5 CM	131
BREISKY VAG.SPEC.BAYONET SH.130X35 MM	268	CASTROVIEJO, MICRO-NEEDLEHOLDER, W. RATCHET, SERRATED, STRAIGHT, 18,0 CM	131
BREISKY VAG.SPEC.BAYONET SH.130X40 MM	268	CASTROVIEJO, MICRO-NEEDLEHOLDER, W. RATCHET, SERRATED, STRAIGHT, 18,0 CM	131
BREISKY VAG.SPEC.BAYONET SH.155X40 MM	268	CASTROVIEJO, MICRO-NEEDLEHOLDER, W. RATCHET, SMOOTH, CURVED, 14,5 CM	131
BRODIE, DIRECTOR (PROBE), GROOVED, WITH BUTTON, 20,0 CM	214	CASTROVIEJO, MICRO-NEEDLEHOLDER, W. RATCHET, SMOOTH, CURVED, 18,0 CM	131
BROPHY (SULLIVAN), FINE SCISSORS STRAIGHT 14.5 CM	31	CASTROVIEJO, MICRO-NEEDLEHOLDER, W. RATCHET, SMOOTH, STRAIGHT, 14,5 CM	131
BROPHY (SULLIVAN), FINE SCISSORS CURVED 14.5 CM	31	CASTROVIEJO, MICRO-NEEDLEHOLDER, W. RATCHET, SMOOTH, STRAIGHT, 18,0 CM	131
BROPHY DRESSING FORCEPS CVD 20,0 CM	68	CASTROVIEJO, MICRO-NEEDLEHOLDER, W. RATCHET, SMOOTH, STRAIGHT, 18,0 CM	131
BROPHY DRESSING FORCEPS STR 20,0 CM	67	CASTROVIEJO, NEEDLE HOLDER W. TC, CVD., SERRATED, 14,0 CM	144
BROPHY TISSUE FCPS 1X2 T CVD 20,0 CM	74	CASTROVIEJO, NEEDLE HOLDER W. TC, CVD., SMOOTH, 14,0 CM	144
BROPHY TISSUE FCPS 1X2 T STR 20,0 CM	74	CASTROVIEJO, NEEDLE HOLDER W. TC, CVD., SMOOTH, 18,0 CM	144
BROWN NEEDLE HOLDER 13.0 CM	125	CASTROVIEJO, NEEDLE HOLDER W. TC, STR., SERRATED, 14,0 CM	144
BROWN TISSUE FORCEPS 15,0 CM	76	CASTROVIEJO, NEEDLE HOLDER W. TC, STR., SMOOTH, 14,0 CM	144
BROWN TISSUE FORCEPS 20,0 CM	76	CASTROVIEJO, NEEDLE HOLDER W. TC, STR., SMOOTH, 18,0 CM	144
BROWN TISSUE FORCEPS 25,0 CM	76	CASTROVIEJO, NEEDLE HOLDER W. TC, STR., WITH RATCHET, SERRATED, 18,0 CM	144
BRUNNER LIGATURE CONDUCTOR FIG.1 30.0 CM	151	CATLIN, AMPUTATING KNIFE, BLADE LENGTH 16,0 CM	8
BRUNNER LIGATURE CONDUCTOR FIG.2 30.0 CM	151	CATLIN, AMPUTATING KNIFE, BLADE LENGTH 22,0 CM	8
BRUNNER LIGATURE CONDUCTOR LEFT 30.0 CM	151	CATLIN, AMPUTATING KNIFE, BLADE LENGTH 22,0 CM	8
BRUNNER LIGATURE CONDUCTOR RIGHT 30.0 CM	151	CHAIN WITH WEIGHT, 645 G, FOR DOYEN RETRACTOR	209
BRUNNER LIGATURE NEEDLE 25.0 CM	148	CHAPUT ARTERY FORCEPS 3X2 TEETH 13.0 CM	96
BRUNNER LIGATURE NEEDLE FIG 1 30.0 CM	148	CHEATLE STERILIZING FORCEPS 27,0 CM	308
BRUNNER LIGATURE NEEDLE FIG 2 30.0 CM	148	CHELSEA EATON, ANOSCOPE, Ø 22 x 65 mm	254
BRUNNER RETRACTOR 100X20 MM 25.0 CM	184	CHELSEA EATON, ANOSCOPE, Ø 30 x 65 MM	254
BRUNNER RETRACTOR 120X25 MM 25.0 CM	184	CHERON DRESSING FORCEPS 25.0 CM	89
BRUNNER RETRACTOR 140X25 MM 25.0 CM	184	CHILDE SUTURE FORCEPS 18.0 CM	155
BRUNNER RETRACTOR 160X30 MM 25.0 CM	184	CHILDE SUTURE FORCEPS CLIP 18.0 CM	155
BRUNNER RETRACTOR 180X30 MM 25.0 CM	184	CHISEL, 10MM 13,5CM	304
BRUNNER RETRACTOR 80X20 MM 25.0 CM	184	CHISEL, 12MM 13,5CM	304
BRUNNER, INTESTINAL CLAMP FORCEPS, 24,0 CM	248	CHISEL, 14MM 13,5CM	304
BRUNNER, INTESTINAL CLAMP FORCEPS, WITH NON-TRAUMATIC SERRATION, 24,0 CM	248	CHISEL, 16MM 13,5CM	304
BRUNNER, RETRACTOR, FLAT FINGER-RING-HANDLE, 100X20 MM 25.0 CM	183	CHISEL, 8MM 13,5CM	304
BRUNNER, RETRACTOR, FLAT FINGER-RING-HANDLE, 120X25 MM 25.0 CM	183	CIRCUMCISION INSTRUMENT 8 MM BABY SIZE	240
BRUNNER, RETRACTOR, FLAT FINGER-RING-HANDLE, 140X25 MM 25.0 CM	183	CIRCUMCISION INSTRUMENT 11 MM CHILD SIZE	240
BRUNNER, RETRACTOR, FLAT FINGER-RING-HANDLE, 160X30 MM 25.0 CM	183	CIRCUMCISION INSTRUMENT 13 MM CHILD SIZE	240
BRUNNER, RETRACTOR, FLAT FINGER-RING-HANDLE, 180X30 MM 25.0 CM	183	CIRCUMCISION INSTRUMENT 16 MM ADOL.SIZE	240
BRUNNER, RETRACTOR, FLAT FINGER-RING-HANDLE, 80X20 MM 25.0 CM	183	CIRCUMCISION INSTRUMENT 21 MM ADOL.SIZE	240
BRUNNER-FERROZELL LIGATURE CONDUCT. 18CM	153	CIRCUMCISION INSTRUMENT 26 MM MEN'S SIZE	240
BRUNNER-FERROZELL LIGATURE CONDUCT. 27CM	153	CIRCUMCISION INSTRUMENT 32 MM MEN'S SIZE	240
BRUNS BONE CURETTE, FIG.0	298	CLAMP 18.0 CM WITH CLIP	91
BRUNS BONE CURETTE, FIG.00	298	CLAUS LIGATURE NEEDLE 23.0 CM	150
BRUNS BONE CURETTE, FIG.000	298	CLAUS-EICKEN LIGATURE NEEDLE 23.0 CM	150
BRUNS BONE CURETTE, FIG.0000	298	COAKLEY ANTRUM TROCER SET 2.25 MM	220
BRUNS BONE CURETTE, FIG.1	298	COGSWELL, SUCTION TUBE, 23,0 CM, Ø 2,0 MM	222
BRUNS BONE CURETTE, FIG.2	298	COHEN, INTRA-UTERINE PROBE, COMPLETE WITH 2 INSERTS	269
BRUNS BONE CURETTE, FIG.3	298	COLLIER NEEDLE HOLDER 12.5 CM	124
BRUNS BONE CURETTE, FIG.4	298	COLLIN ABDOMINAL RETRACTOR 22.0 CM LATERAL BLADES: 38X80MM	199
BRUNS BONE CURETTE, FIG.5	298	CENTRAL BLADES: 55X65MM	199
BRUNS BONE CURETTE, FIG.6	298	COLLIN ABDOMINAL RETRACTOR 22.0 CM LATERAL VALVES: 38X100MM	199
BRUNS PL.-OF-PARIS SHEARS 24.0 CM SMOOTH	45	CENTRAL BLADES: 55X75MM	199
BRUNS PLASTER-OF-PARIS SHEARS 24.0CM SAW	45	COLLIN AMPUTATING KNIFE, BLADE LENGTH 13,0 CM	8
BRUNS, BANDAGE SCISSORS TC, 24.0 CM	55	COLLIN CLIP FORCEPS 13.0 CM	154
BRUSH DISPENSER FOR 10 BRUSHES	311	COLLIN DRESSING FORCEPS 24.0 CM	89
BRUSH DISPENSER FOR 20 BRUSHES	311	COLLIN SEIZING FCPS OVAL 16.0 CM	96
BRYANT, SPONGE AND DRESSING FCPS., 13.0 CM	88	COLLIN VAG.SPECULUM 100 X 35 MM	258
BUCK LIGATURE SCISSORS 14.5 CM	33	COLLIN VAG.SPECULUM 110 X 40 MM	258
BUCK LIGATURE SCISSORS 18.0 CM	33	COLLIN VAG.SPECULUM 85 X 30 MM	258
BUELAU TROCER 24.0 CM 8 MM	219	COLLIN, ABDOMINAL RETRACTOR COMPL. LATERAL VALVES 32 X 62 MM, SPRIDING WIDE 135 X 160 MM, 23.5 CM	199
BUMM, UTERINE CURETTE, BLUNT, MALLEABLE, FIG. 1, Ø 30 MM, 31,0 CM	285	COLLIN, ABDOMINAL RETRACTOR, VALVE ONLY, 100X38 MM	200
BUMM, UTERINE CURETTE, BLUNT, MALLEABLE, FIG. 2, Ø 35 MM, 31,0 CM	285		
BUMM, UTERINE CURETTE, BLUNT, MALLEABLE, FIG. 3, Ø 40 MM, 31,0 CM	285		
BUMM, UTERINE CURETTE, BLUNT, RIGID, FIG. 1, Ø 30 MM, 31,0 CM	285		
BUMM, UTERINE CURETTE, BLUNT, RIGID, FIG. 2, Ø 35 MM, 31,0 CM	285		
BUMM, UTERINE CURETTE, BLUNT, RIGID, FIG. 3, Ø 40 MM, 31,0 CM	285		
BUMM, UTERINE CURETTE, SHARP, MALLEABLE, FIG. 1, Ø 30 MM, 31,0 CM	284		
BUMM, UTERINE CURETTE, SHARP, MALLEABLE, FIG. 2, Ø 35 MM, 31,0 CM	284		
BUMM, UTERINE CURETTE, SHARP, MALLEABLE, FIG. 3, Ø 40 MM, 31,0 CM	284		
BUMM, UTERINE CURETTE, SHARP, RIGID, FIG. 1, Ø 30 MM, 31,0 CM	284		

COLLIN, ABDOMINAL RETRACTOR, VALVE ONLY, 55X55 MM	200	CUSHING RECTRACTOR 18 MM 20.0 CM	165
COLLIN, ABDOMINAL RETRACTOR, VALVE ONLY, 55X65 MM	200	CUSHING RECTRACTOR 8 MM 20.0 CM	165
COLLIN, ABDOMINAL RETRACTOR, VALVE ONLY, 55X75 MM	200	CUSHING RECTRACTOR 10MM 24.0 CM	165
COLLIN, ABDOMINAL RETRACTOR, VALVE ONLY, 58X50 MM	200	CUSHING RECTRACTOR 12 MM 24.0 CM	165
COLLIN, ABDOMINAL RETRACTOR, VALVE ONLY, 62X38 MM	200	CUSHING RECTRACTOR 14 MM 24.0 CM	165
COLLIN, ABDOMINAL RETRACTOR, VALVE ONLY, 80X38 MM	200	CUSHING RECTRACTOR 16 MM 24.0 CM	165
COLLIN, ABDOMINAL RETRACTOR, VALVE ONLY, 80X60 MM	200	CUSHING RECTRACTOR 18 MM 24.0 CM	165
COLLIN, ABDOMINAL RETRACTOR, VALVE ONLY, 85X72 MM	200	CUSHING RECTRACTOR 8 MM 24.0 CM	165
COLLIN, AMPUTATING KNIFE, BLADE LENGTH 22,0 CM	8	CUSHING SPINAL RETRACTORS, 20,0 CM	166
COLLIN, AMPUTATING KNIFE, BLADE LENGTH 28,0 CM	8	CUSHING TISSUE FORCEPS CVD 1X2 T.17.5 CM	74
COLLIN, AMPUTATING KNIFE, HOLLOW HANDLE, FIG.1	8	CUSHING TISSUE FORCEPS STR 1X2 T. 17.5CM	74
COLLIN, AMPUTATING KNIFE, BLADE LENGTH, 19,0 CM	8	CUSHING, NERVE HOOK, FIG. 1 4 MM, 19,0 CM	161
COLLIN, MALLETS STEEL SOLID, Ø30.0 MM, 220G, 20,0 CM	306	CUSHING, NERVE HOOK, FIG. 2 6 MM, 19,0 CM	161
COLLIN, OPERATING KNIFE, HOLLOW HANDLE, FIG.1	6	CUSHING-TAYLOR FCPS.TC 18.0 CM	83
COLLIN, OPERATING KNIFE, HOLLOW HANDLE, FIG.2	6	CYLINDER ONLY, INSULINE SYRINGE, LUER, 1 ML	227
COLLIN, OPERATING KNIFE, HOLLOW HANDLE, FIG.3	6	CYLINDER ONLY, INSULINE SYRINGE, LUER, 2 ML	227
COLLIN, OPERATING KNIFE, HOLLOW HANDLE, FIG.4	6	CYLINDER ONLY, JANET, WOUND A. BLADDER SYRINGE, 100 ML	228
COLLIN, OPERATING KNIFE, HOLLOW HANDLE, FIG.5	6	CYLINDER ONLY, JANET, WOUND A. BLADDER SYRINGE, 150 ML	228
COLLIN, OPERATING KNIFE, HOLLOW HANDLE, FIG.6	6	CYLINDER ONLY, JANET, WOUND A. BLADDER SYRINGE, 200 ML	228
COLLIN, UTERINE ELEVATING FORCEPS, 25,0 CM	277	CYLINDER ONLY, JANET, WOUND A. BLADDER SYRINGE, ONLY 50 ML	228
COLLIN, UTERINE PROBE, Ø 4 MM, 28,0 CM	277	CYLINDER ONLY, SYRINGE LUER, 1 ML	227
COLLIN, VAGINAL SPECULA F. CHILDREN, 65 X 10 MM	258	CYLINDER ONLY, SYRINGE LUER, 10 ML	227
COLLIN, VAGINAL SPECULA F. VIRGINS, 65 x 20 MM	258	CYLINDER ONLY, SYRINGE LUER, 2 ML	227
COLLIN-BABY ABDOMINAL RETRACTOR COMPLETE	198	CYLINDER ONLY, SYRINGE LUER, 20 ML	227
COLLIN-DUVAL GRASPING FCPS 20,0 CM/14 MM	75	CYLINDER ONLY, SYRINGE LUER, 5 ML	227
COLLIN-DUVAL GRASPING FCPS 20,0 CM/18 MM	75	CYLINDER ONLY, SYRINGE LUER, 50 ML	227
COLLIN-DUVAL GRASPING FCPS 20,0 CM/27 MM	75	CYLINDER ONLY, SYRINGE, LUER-LOCK, 1 ML	227
CONE LARGE, ONLY	269	CYLINDER ONLY, SYRINGE, LUER-LOCK, 10 ML	227
CONE SMALL, ONLY	269	CYLINDER ONLY, SYRINGE, LUER-LOCK, 10 ML	228
CONNECTING PIECE, LUER-LOCK FEMALE	229	CYLINDER ONLY, SYRINGE, LUER-LOCK, 2 ML	227
CONNECTING PIECE, LUER-LOCK MALE, Ø 6 MM	229	CYLINDER ONLY, SYRINGE, LUER-LOCK, 20 ML	227
CONNECTING PIECE, LUER-LOCK MALE, Ø 8 MM	229	CYLINDER ONLY, SYRINGE, LUER-LOCK, 20 ML	228
CONNECTING PIECE, LUER-LOCK, FEMALE	229	CYLINDER ONLY, SYRINGE, LUER-LOCK, 30 ML	228
CONNECTING PIECE, LUER-LOCK, MALE	229	CYLINDER ONLY, SYRINGE, LUER-LOCK, 5 ML	227
CONNECTING PIECE, LUER-LOCK, MALE	229	CYLINDER ONLY, SYRINGE, LUER-LOCK, 50 ML	227
COOLEY SUCTION TUBE 30.0 CM, Ø 7,0 MM	222	CYLINDER ONLY, SYRINGE, LUER-LOCK, 50 ML	228
COOLEY SUCTION TUBE 31.0 CM, Ø 10,0 MM	222	CYLINDER ONLY, TUBERCULINE SYRINGE, LUER-LOCK, 1ML	228
COOLEY SUCTION TUBE 33.0 CM, Ø 8,0 MM	222	CZERNY, GALL STONE FORCEPS, 24,5 CM	233
COOLEY SUCTION TUBE 35.0 CM, Ø 8,0 MM	222	CZERNY, RETRACTOR, DOUBLE-ENDED, SOLID/ 2 PRONG BLUNT, 17,5 CM	168
COOPER LIGATURE NEEDLE 19.0 CM	147	CZERNY, UTERINE TENACULUM FORCEPS, 4X4 TEETH, 20,5 CM	275
COOPER LIGATURE NEEDLE 20.0 CM	147	DANDY NEUROSURGICAL SCISSORS 17.0 CM	34
CORONARY SCISSORS 11.5 CM	39	DANDY ARTERY FCPS CVD 1X2 T. 14.0 CM	102
CORYLLOS RETRACTOR 115X60 MM 24.0 CM	182	DARTIGUES UTER.ELEVATING FORCEPS 27.0 CM	276
CORYLLOS RETRACTOR 82X22 MM 24.0 CM	182	DAUBENSPECK, BONE CURETTE, FIG. 0, 20,0 CM	299
CORYLLOS RETRACTOR 82X22 MM 24.0 CM	182	DAUBENSPECK, BONE CURETTE, FIG. 00, 20,0 CM	299
COTTLE NASAL SCISSORS BLUNT 16.0 CM	35	DAUBENSPECK, BONE CURETTE, FIG. 1, 20,0 CM	299
COTTLE, NASAL SCS., SUPER CUT, BL/BL, 16,5 CM	58	DAUBENSPECK, BONE CURETTE, FIG. 2, 20,0 CM	299
COUPLAND, EXCHANGEABLE SUCTION TUBE, Ø 3,5 MM	222	DAVIDSON RETRACTOR 75X50 MM 16.0 CM	186
COUPLAND, HANDLE FOR SUCTION TUBE, 17,0 CM	222	DAVIDSON RETRACTOR 75X90 MM 16.0 CM	186
CRAFOORD ARTERY FORCEPS CVD 24.0 CM	104	DE BAKEY ARTERY SCISSORS 15.5 CM	38
CRAFOORD LOBECTOMY SCS CVD BL 30.0 CM	39	DE BAKEY ARTERY SCISSORS 15.5 CM	38
CRAFOORD-SELLORS BRONCHUS FORCEPS 22.0CM	115	DE BAKEY ATRAUMA BULLD.CLAMP CVD 10.0 CM	95
CRAFOORD-SELLORS BRONCHUS FORCEPS 23.0CM	115	DE BAKEY ATRAUMA BULLD.CLAMP CVD 11.5 CM	95
CRAFOORD-SELLORS BRONCHUS FORCEPS 24.0CM	115	DE BAKEY ATRAUMA BULLDOG CLAMP STRAIGHT, 10,5 CM	95
CRILE ARTERY FORCEPS CVD 1X2 T. 14.0 CM	102	DE BAKEY ATRAUMA BULLDOG CLAMP STRAIGHT, 12,0 CM	95
CRILE ARTERY FORCEPS STR 1X2 T. 14.0 CM	102	DE BAKEY ATRAUMA BULLDOG CLAMP STRAIGHT, 7,5 CM	95
CRILE FORCEPS CURVED 14,0 CM	102	DE BAKEY ATRAUMA BULLDOG CLAMP STRAIGHT, 8,5 CM	95
CRILE FORCEPS STR 14.0 CM	102	DE BAKEY ATRAUMA BULLDOG CLAMP CVD 7.0CM	95
CRILE-MURRAY, NEEDLE HOLDER, 15,0 CM	125	DE BAKEY ATRAUMA BULLDOG CLAMP CVD 8.0CM	95
CRILE-RANKIN, ARTERY FORCEPS, 1X2 TEETH, CVD., 16,0 CM	103	DE BAKEY ATRAUMA FCPS ANGLED 1.5 MM 20.0 CM	81
CRILE-RANKIN, ARTERY FORCEPS, 1X2 TEETH, STR., 16,0 CM	103	DE BAKEY ATRAUMA FCPS ANGLED 1.5 MM 24.0 CM	81
CRILE-RANKIN, ARTERY FORCEPS, CVD, 16,0 CM	103	DE BAKEY ATRAUMA FCPS ANGLED 1.5 MM 30,0 CM	81
CRILE-RANKIN, ARTERY FORCEPS, STR, 16,0 CM	103	DE BAKEY ATRAUMA FCPS CVD 2.0 MM 24.0 CM	81
CRILE-WOOD NEEDLE HOLDER 15,0 CM	125	DE BAKEY ATRAUMA FCPS CVD 2.0 MM 30.0 CM	81
CRILE-WOOD NEEDLE HOLDER TC 15.0 CM	134	DE BAKEY ATRAUMA FCPS CVD 2.0MM 16.0 CM	81
CRILE-WOOD NEEDLE-HOLDER TC 18.0 CM	134	DE BAKEY ATRAUMA FCPS CVD 2.0MM 20.0 CM	81
CUSCO VAG.SPEC.W.CENTR.RAT.100X37 MM	259	DE BAKEY ATRAUMA FCPS STR 1.5 MM 24.0 CM	81
CUSCO VAG.SPECULUM SWISS PATT.100X25 MM	259	DE BAKEY ATRAUMA FCPS STR 1.5 MM 30,0 CM	81
CUSCO VAG.SPECULUM SWISS PATT.105X27 MM	259	DE BAKEY ATRAUMA FCPS STR 2.4MM 24.0 CM	81
CUSCO VAG.SPECULUM SWISS.PATT. 80X22 MM	259	DE BAKEY ATRAUMA FCPS STR 2.4MM 30.0 CM	81
CUSCO VAG.SPECULUM W.CENTR.RAT.74X32 MM	259	DE BAKEY ATRAUMA FCPS STR 2.8 MM 16.0 CM	81
CUSCO VAG.SPECULUM W.CENTR.RAT.85X35 MM	259	DE BAKEY ATRAUMA FCPS STR 2,8 MM 20.0 CM	81
CUSCO VAGINAL SPECULUM 100X35 MM	259	DE BAKEY ATRAUMA FCPS STR 2,8 MM 24.0 CM	81
CUSCO VAGINAL SPECULUM 75X32 MM	259	DE BAKEY ATRAUMA FCPS STR 2.8 MM 30.0 CM	81
CUSCO VAGINAL SPECULUM 85X35 MM	259	DE BAKEY ATRAUMA FCPS STR 2.8 MM 24.0 CM	81
CUSCO VAGINAL SPECULUM VIRGIN S.75X17 MM	259	DE BAKEY ATRAUMA FCPS STR 2.8 MM 30.0 CM	81
CUSCO, VAGINAL SPECULA, 105 x 25 MM	258	DE BAKEY ATRAUMA FCPS STR 3.5 MM 16.0 CM	81
CUSCO, VAGINAL SPECULA, 107 x 29 MM	258	DE BAKEY ATRAUMA FCPS STR 3.5 MM 16.0 CM	81
CUSCO, VAGINAL SPECULA, 115 x 35 MM	258	DE BAKEY ATRAUMA FCPS STR 3.5 MM 20.0 CM	81
CUSCO, VAGINAL SPECULA, 80 x 24 MM	258	DE BAKEY ATRAUMA FCPS STR 3.5 MM 20.0 CM	81
CUSCO, VAGINAL SPECULA, 80 x 32 MM	258	DE BAKEY ATRAUMA FCPS STR 3.5 MM 24.0 CM	81
CUSCO, VAGINAL SPECULA, 98 x 16 MM	258	DE BAKEY ATRAUMA FCPS STR 3.5 MM 24.0 CM	81
CUSHING DRESSING FORCEPS CVD 17.5 CM	67	DE BAKEY ATRAUMA FCPS STR 3.5 MM 30.0 CM	81
CUSHING DRESSING FORCEPS STR 17.5 CM	67	DE BAKEY ATRAUMA FCPS STR 3.5 MM 30.0 CM	81
CUSHING FCPS TC 17.5 CM	83	DE BAKEY ATRAUMA FCPS.ANGLED 1,5 MM 16.0 CM	81
CUSHING FCPS TC CVD 17.5 CM	83	DE BAKEY NEEDLE HOLDER TC 18.0 CM	136
CUSHING RECTRACTOR 10 MM 20.0 CM	165	DE BAKEY NEEDLE HOLDER TC 20.0 CM	136
CUSHING RECTRACTOR 12 MM 20.0 CM	165	DE BAKEY NEEDLE HOLDER TC 23.0 CM	136
CUSHING RECTRACTOR 14 MM 20.0 CM	165	DE BAKEY NEEDLE HOLDER TC 26.0 CM	136
CUSHING RECTRACTOR 16 MM 20.0 CM	165	DE BAKEY NEEDLE HOLDER TC 31.0 CM	136

DE BAKEY NEEDLE HOLDER TC 37.0 CM	136	DELICATE HOOK FIG.4 16.0 CM	159
DE BAKEY, SUCTION TUBE, 27.0 CM	222	DENNIS-BROWN, DRESSING FORCEPS, 20.0 CM	68
DE BAKEY, VASCULAR FORCEPS, ATRAUMATIC Ø 1.5 MM, 16.0 CM	81	DENNIS-BROWNE, ABDOMINAL RETRACTOR, COMPLETE	205
DE BAKEY, VASCULAR FORCEPS, ATRAUMATIC Ø 1.5 MM, 20.0 CM	81	DENNIS-BROWNE, ABDOMINAL RETRACTOR, FRAME ONLY	205
DE BAKEY, VASCULAR FORCEPS, ATRAUMATIC Ø 2.0 MM, 16.0 CM	81	DENNIS-BROWNE, ABDOMINAL RETRACTOR, VALVES ONLY, 40X30 MM	205
DE BAKEY, VASCULAR FORCEPS, ATRAUMATIC Ø 2.0 MM, 20.0 CM	81	DENNIS-BROWNE, ABDOMINAL RETRACTOR, VALVES ONLY, 40X40 MM	205
DE BAKEY, VASCULAR FORCEPS, ATRAUMATIC Ø 2.4 MM, 16.0 CM	81	DERF NEEDLE HOLDER 12.0 CM	124
DE BAKEY, VASCULAR FORCEPS, ATRAUMATIC Ø 2.4 MM, 20.0 CM	81	DERF, NEEDLE HOLDER, WITH TC, 12.0 CM	133
DE BAKEY, VASCULAR FORCEPS, ATRAUMATIC Ø 2.8 MM, 16.0 CM	81	DERF-CONVERSE NEEDLE HOLDER 12.5 CM	124
DE BAKEY, VASCULAR FORCEPS, ATRAUMATIC Ø 2.8 MM, 20.0 CM	81	DESCHAMPS NEEDLE LEFT BLUNT MEDIUM 20 CM	146
DE BAKEY, VASCULAR FORCEPS, ATRAUMATIC STR Ø 2.0MM 24.0 CM	81	DESCHAMPS NEEDLE LEFT BLUNT SMALL 20.0CM	146
DE BAKEY, VASCULAR FORCEPS, ATRAUMATIC STR Ø 2.0MM 30.0 CM	81	DESCHAMPS NEEDLE LEFT BLUNT WIDE 21.0 CM	147
DE BAKEY, VASCULAR SCISSORS WITH TC- INSERTS 45° ANGLED, 18,0 CM	53	DESCHAMPS NEEDLE LEFT BLUNT WIDE 27.0 CM	147
DE BAKEY, VASCULAR SCISSORS WITH TC- INSERTS 45° ANGLED, 23,0 CM	53	DESCHAMPS NEEDLE LEFT RIGHT WIDE 21.0 CM	147
DE BAKEY, VASCULAR SCISSORS WITH TC-INSERTS, 25° ANGLED, 18,0 CM	53	DESCHAMPS NEEDLE LEFT SHARP MEDIUM 20 CM	146
DE BAKEY, VASCULAR SCISSORS WITH TC-INSERTS, 25° ANGLED, 23,0 CM	53	DESCHAMPS NEEDLE LEFT SHARP WIDE 21.0 CM	147
DE BAKEY, VASCULAR SCISSORS, 25°, 16,0 CM	36	DESCHAMPS NEEDLE LEFT SHARP WIDE 27.0 CM	147
DE BAKEY, VASCULAR SCISSORS, 25°, 19,0 CM	36	DESCHAMPS NEEDLE RIGHT BLUNT MED 20.0 CM	146
DE BAKEY, VASCULAR SCISSORS, 25°, 21,0 CM	36	DESCHAMPS NEEDLE RIGHT BLUNT SMALL 20 CM	146
DE BAKEY, VASCULAR SCISSORS, 25°, 23,0 CM	36	DESCHAMPS NEEDLE RIGHT BLUNT WIDE 21.0CM	147
DE BAKEY, VASCULAR SCISSORS, 25°, 28,0 CM	36	DESCHAMPS NEEDLE RIGHT BLUNT WIDE 27.0CM	147
DE BAKEY, VASCULAR SCISSORS, 45°, 16,0 CM	36	DESCHAMPS NEEDLE RIGHT SHARP MED 20.0 CM	146
DE BAKEY, VASCULAR SCISSORS, 45°, 19,0 CM	36	DESCHAMPS NEEDLE RIGHT SHARP WIDE 27.0CM	147
DE BAKEY, VASCULAR SCISSORS, 45°, 21,0 CM	36	DESCHAMPS, LIGATURE NEEDLE FOR RIGHT HAND, SMALL CURVED SHARP, 20.0 CM	146
DE BAKEY, VASCULAR SCISSORS, 45°, 23,0 CM	36	DESCHAMPS, LIGATURE NEEDLE FOR THE LEFT HAND, SMALL CURVED SHARP, 20.0 CM	146
DE BAKEY, VASCULAR SCISSORS, 45°, 28,0 CM	36	DESJARDINS GALL DUCT CLAMP 21,0 CM	114
DE BAKEY, VASCULAR SCISSORS, 60°, 16,0 CM	36	DESJARDINS GALL STONE FCPS.23.0 CM FIG.1	232
DE BAKEY, VASCULAR SCISSORS, 60°, 19,0 CM	36	DESJARDINS GALL STONE FCPS.23.0 CM FIG.2	232
DE BAKEY, VASCULAR SCISSORS, 60°, 21,0 CM	36	DESJARDINS, GALL STONE PROBE, FIG. 1, 28.0 CM	235
DE BAKEY, VASCULAR SCISSORS, 60°, 23,0 CM	36	DESJARDINS, GALL STONE PROBE, FIG. 2, 28.0 CM	235
DE BAKEY, VASCULAR SCISSORS, 60°, 28,0 CM	36	DESJARDINS, GALL STONE PROBE, FIG. 3, 28.0 CM	235
DE BAKEY, VASCULAR SCISSORS, WITH TC-INSERTS 60° ANGLED, 18,0 CM	53	DESJARDINS, GALL STONE SCOOP, ELASTIC, FIG. 1, Ø 6 MM/18 CHAR., 28.0 CM	235
DE BAKEY, VASCULAR SCISSORS, WITH TC-INSERTS 60° ANGLED, 23,0 CM	53	DESJARDINS, GALL STONE SCOOP, ELASTIC, FIG. 2, Ø 7.0 MM/ 21 CHAR., 28.0 CM	235
DE LA ROZA LIGATURE NEEDLE LEFT 12.0 CM	149	DESJARDINS, GALL STONE SCOOP, ELASTIC, FIG. 3, Ø 8.0 MM/ 24 CHAR. 28.0 CM	235
DE LA ROZA LIGATURE NEEDLE RIGHT 12.0 CM	149	DESJARDINS, GALL STONE SCOOP, ELASTIC, FIG. 4, Ø 9.0 MM/ 27 CHAR. 28.0 CM	235
DE LEE, OBSTETRICAL FORCEPS, 30.0CM	289	DESMARRES RETRACTOR 10 MM 16.0 CM	164
DE LEE, OBSTETRICAL FORCEPS, 36, 0 CM	289	DESMARRES RETRACTOR 12 MM 16.0 CM	164
DE LEE, OBSTETRICAL FORCEPS, 38, 0 CM	289	DESMARRES RETRACTOR 14 MM 16.0 CM	164
DE MARTEL-WOLFSON CLAMP CLOS.FCPS 26.0CM	249	DESMARRES RETRACTOR 16 MM 16.0 CM	164
DE MARTEL-WOLFSON CLAMP HOLDER 8,5 CM	249	DESMARRES RETRACTOR 18 MM 16.0	164
DE MARTEL-WOLFSON COLON-ANASTOMOSIS CLAMP FORCEPS, SET W. 3 PCS., 10 CM	249	DESMARRES RETRACTOR 8 MM 16.0 CM	164
DE MARTEL-WOLFSON COLON-ANASTOMOSIS CLAMP FORCEPS, SET W. 3 PCS., 5 CM	249	DESMARRES, RETRACTOR 10.0 MM, 13.0 CM	164
DE MARTEL-WOLFSON COLON-ANASTOMOSIS CLAMP FORCEPS, SET W. 3 PCS., 7 CM	249	DESMARRES, RETRACTOR 12.0 MM, 13.0 CM	164
DEAVER RETRACTOR 25 MM 30.5 CM	186	DESMARRES, RETRACTOR 14.0 MM, 13.0 CM	164
DEAVER RETRACTOR 38 MM 30,5 CM	186	DESMARRES, RETRACTOR 16.0 MM, 13.0 CM	164
DEAVER RETRACTOR 50 MM 30.5 CM	186	DESMARRES, RETRACTOR 18.0 MM, 13.0 CM	164
DEAVER RETRACTOR 75 MM 30.5 CM	186	DESMARRES, RETRACTOR 8.0 MM, 13.0 CM	164
DEAVER RETRACTOR WIDTH 19 MM 18.0 CM	184	DIEFFENBACH BULLDOG CLAMPS CVD 3.5 CM	94
DEAVER RETRACTOR WIDTH 22 MM 21.5 CM	184	DIEFFENBACH BULLDOG CLAMPS CVD 5.0 CM	94
DEAVER RETRACTOR WIDTH 25 MM 23.0 CM	184	DIEFFENBACH BULLDOG CLAMPS STR 3.5 CM	94
DEAVER RETRACTOR WIDTH 25 MM 30.0 CM	185	DIEFFENBACH BULLDOG CLAMPS STR 5.0 CM	94
DEAVER RETRACTOR WIDTH 25 MM 33.0 CM	185	DIEFFENBACH OPERATING KNIFE FIG.1	7
DEAVER RETRACTOR WIDTH 25 MM 36.0 CM	185	DIEFFENBACH OPERATING KNIFE FIG.10	7
DEAVER RETRACTOR WIDTH 25 MM 38.0 CM	185	DIEFFENBACH OPERATING KNIFE FIG.2	7
DEAVER RETRACTOR WIDTH 38 MM 30.0 CM	185	DIEFFENBACH OPERATING KNIFE FIG.3	7
DEAVER RETRACTOR WIDTH 50 MM 30.0 CM	185	DIEFFENBACH OPERATING KNIFE FIG.4	7
DEAVER RETRACTOR WIDTH 75 MM 30.0 CM	185	DIEFFENBACH OPERATING KNIFE FIG.5	7
DEAVER, SURGICAL SCISSORS CURVED, SHARP/ SHARP, 13,0 CM	16	DIEFFENBACH OPERATING KNIFE FIG.6	7
DEAVER, SURGICAL SCISSORS STRAIGHT, BLUNT/BLUNT, 12,0 CM	15	DIEFFENBACH OPERATING KNIFE FIG.7	7
DEAVER, SURGICAL SCISSORS, CURVED, BLUNT/ BLUNT, 12,0 CM	15	DIEFFENBACH OPERATING KNIFE FIG.8	7
DEAVER, SURGICAL SCISSORS, CURVED, BLUNT/ BLUNT, 12,0 CM	15	DIEFFENBACH, OPERATING KNIFE, FIG. 15, 16,0 CM	7
DEAVER, SURGICAL SCISSORS, CURVED, BLUNT/ BLUNT, 14,5 CM	15	DIEFFENBACH, OPERATING KNIFE, FIG. 16, 16,0 CM	7
DEAVER, SURGICAL SCISSORS, CURVED, SHARP/ BLUNT, 12,0 CM	16	DIEFFENBACH, OPERATING KNIFE, FIG. 2, 16,0 CM	7
DEAVER, SURGICAL SCISSORS, CURVED, SHARP/ BLUNT, 13,0 CM	16	DIEFFENBACH, OPERATING KNIFE, FIG. 3, 16,0 CM	7
DEAVER, SURGICAL SCISSORS, CURVED, SHARP/ BLUNT, 14, 5 CM	16	DIEFFENBACH, OPERATING KNIFE, FIG. 4, 16,0 CM	7
DEAVER, SURGICAL SCISSORS, CURVED, SHARP/ SHARP, 12,0 CM	16	DIEFFENBACH, OPERATING KNIFE, FIG. 5, 16,0 CM	7
DEAVER, SURGICAL SCISSORS, CURVED, SHARP/ SHARP, 14, 5 CM	16	DIEFFENBACH, OPERATING KNIFE, FIG. 7, 16,0 CM	7
DEAVER, SURGICAL SCISSORS, STRAIGHT, BLUNT/ BLUNT, 13,0 CM	15	DIEFFENBACH, OPERATING KNIFE, FIG. 9, 16,0 CM	7
DEAVER, SURGICAL SCISSORS, STRAIGHT, BLUNT/ BLUNT, 14,5 CM	15	DIEFFENBACH, OPERATION KNIFE, FIG. 6, 16,0 CM	7
DEAVER, SURGICAL SCISSORS, STRAIGHT, SHARP/ BLUNT, 12,0 CM	16	DIEFFENBACH, OPERATION KNIFE, FIG. 8, 16,0 CM	7
DEAVER, SURGICAL SCISSORS, STRAIGHT, SHARP/ BLUNT, 13,0 CM	16	DIEFFENBACH, OPERATING KNIFE, FIG. 1, 16,0 CM	7
DEAVER, SURGICAL SCISSORS, STRAIGHT, SHARP/ BLUNT, 14,5 CM	16	DIEFFENBACH OPERATING KNIFE FIG.9	7
DeBAKEY, SELF-RETAINING RETRACTOR, SHARP, 10,0 CM	195	DIETHRICH MICRO NEEDLE HOLDER TC 26.0CM	133
DeBAKEY, SELF-RETAINING RETRACTOR, SHARP, 17,0 CM	195	DIETHRICH MICRO-NEEDLE HOLDER TC 16.0CM	133
DELICATE HOOK 1 PRONG BLUNT 16.0 CM	161	DIETHRICH MICRO-NEEDLE HOLDER TC 18.0CM	133
DELICATE HOOK 1 PRONG SHARP 16.0 CM	161	DIETHRICH MICRO-NEEDLE HOLDER TC 20.0CM	133
DELICATE HOOK 2 PRONGS BLUNT 16.0 CM	161	DIETHRICH MICRO-NEEDLE HOLDER TC 23.0CM	133
DELICATE HOOK 2-PRONGS SHARP 16.0 CM	161	DIETHRICH, VASCULAR SCS. TC, 125°, 17.5 CM	53
DELICATE HOOK 3 PRONGS BLUNT 16.0 CM	161	DIETHRICH-HEGEMANN, VASCULAR SCS. TC, 25°, 18.0 CM	54
DELICATE HOOK 3 PRONGS SHARP 16.0 CM	161	DIETHRICH-HEGEMANN, VASCULAR SCS. TC, 45°, 18.0 CM	54
DELICATE HOOK 4 PRONGS BLUNT 16.0 CM	161	DIETHRICH-HEGEMANN, VASCULAR SCS. TC, 60°, 18.0 CM	54
DELICATE HOOK 4 PRONGS SHARP 16.0 CM	161	DIETHRICH-HEGEMANN, VASCULAR SCS. TC, 90°, 18.0 CM	54
DELICATE HOOK FIG.1 16.0 CM	159	DIRECTOR (PROBE), GROOVED, WITH BUTTON, 13.0 CM	215
DELICATE HOOK FIG.2 16.0 CM	159	DIRECTOR (PROBE), GROOVED, WITH BUTTON, 14.5 CM	215
DELICATE HOOK FIG.3 16.0 CM	159	DIRECTOR (PROBE), GROOVED, WITH BUTTON, 16.0 CM	215

DIRECTOR (PROBE), GROOVED, WITH BUTTON, 18.0 CM	215	DRESSING FORCEPS FINE 16.0CM	64
DISCONTINUED	32	DRESSING FORCEPS FINE 18.0CM	64
DISCONTINUED	200	DRESSING FORCEPS FINE 20.0CM	64
DISPOSABLE SCALPELS, STERILE, FIG. 10, BOX W. 10 PCS.	4	DRESSING FORCEPS FINE 25.0CM	64
DISPOSABLE SCALPELS, STERILE, FIG. 11, BOX W. 10 PCS.	4	DRESSING FORCEPS FINE 30.0CM	64
DISPOSABLE SCALPELS, STERILE, FIG. 11S, BOX W. 10 PCS.	4	DRESSING FORCEPS MOD.USA 13.0 CM	65
DISPOSABLE SCALPELS, STERILE, FIG. 12, BOX W. 10 PCS.	4	DRESSING FORCEPS MOD.USA 14.5 CM	65
DISPOSABLE SCALPELS, STERILE, FIG. 12D, BOX W. 10 PCS.	4	DRESSING FORCEPS MOD.USA 15.5 CM	65
DISPOSABLE SCALPELS, STERILE, FIG. 13, BOX W. 10 PCS.	4	DRESSING FORCEPS MOD.USA 18.0 CM	65
DISPOSABLE SCALPELS, STERILE, FIG. 15, BOX W. 10 PCS.	4	DRESSING FORCEPS MOD.USA 21.0 CM	65
DISPOSABLE SCALPELS, STERILE, FIG. 15C, BOX W. 10 PCS.	4	DRESSING FORCEPS MOD.USA 25.0 CM	65
DISPOSABLE SCALPELS, STERILE, FIG. 18, BOX W. 10 PCS.	5	DRESSING FORCEPS MOD.USA 31.0 CM	65
DISPOSABLE SCALPELS, STERILE, FIG. 19, BOX W. 10 PCS.	5	DRESSING FORCEPS NARROW 10.5 CM	64
DISPOSABLE SCALPELS, STERILE, FIG. 20, BOX W. 10 PCS.	5	DRESSING FORCEPS NARROW 11,5 CM	64
DISPOSABLE SCALPELS, STERILE, FIG. 21, BOX W. 10 PCS.	5	DRESSING FORCEPS NARROW 13,0 CM	64
DISPOSABLE SCALPELS, STERILE, FIG. 22, BOX W. 10 PCS.	5	DRESSING FORCEPS NARROW 14,5 CM	64
DISPOSABLE SCALPELS, STERILE, FIG. 23, BOX W. 10 PCS.	5	DRESSING FORCEPS NARROW 16,0 CM	64
DISPOSABLE SCALPELS, STERILE, FIG. 24, BOX W. 10 PCS.	5	DRESSING FORCEPS NARROW 18,0 CM	64
DISPOSABLE SCALPELS, STERILE, FIG. 25, BOX W. 10 PCS.	5	DRESSING FORCEPS NARROW 20,0 CM	64
DISSECTION MICRO SCISSORS BL/BL 14.5 CM CURVED	60	DRESSING FORCEPS NARROW 25,0 CM	64
DISSECTION MICRO SCISSORS BL/BL 15.0 CM	60	DRESSING FORCEPS NARROW 30,0 CM	64
DISSECTION MICRO SCISSORS BL/BL 18.0 CM	60	DRESSING FORCEPS NARROW CVD 10.5 CM	64
DISSECTION MICRO SCISSORS BL/BL, SERRATED, 15.0 CM	60	DRESSING FORCEPS NARROW CVD 11.5 CM	64
DIXON-LOVELACE ART.FORCEPS STR 15.5 CM	103	DRESSING FORCEPS NARROW CVD 13.0 CM	64
DIXON-LOVELACE STR.1X2 T 15.5 CM	103	DRESSING FORCEPS NARROW CVD 14.5 CM	64
DOUGALS TROCAR 11.0 CM 3.0 MM	221	DRESSING FORCEPS NARROW CVD 16.0 CM	64
DOYEN ABD.SCISSORS CVD BL/BL 16.0 CM	40	DRESSING FORCEPS NARROW CVD 18.0 CM	64
DOYEN ABD.SCISSORS STR BL/BL 16.0 CM	40	DRESSING FORCEPS NARROW CVD 20.0 CM	64
DOYEN ABD.SCISSORS STR SH/BL 16.0 CM	40	DRESSING FORCEPS NARROW CVD 25.0 CM	64
DOYEN ABDOMINAL SCISSORS CURVED 17,5 CM	40	DRESSING FORCEPS NARROW CVD 30.0 CM	64
DOYEN ABDOMINAL SCISSORS STRAIGHT 17,5CM	40	DRESSING FORCEPS, ENGL. PATTERN, 13,0 CM	67
DOYEN AT INTEST.CLAMP FCPS. CVD. 21.0 CM	246	DRESSING FORCEPS, ENGL. PATTERN, 14,5 CM	67
DOYEN AT INTEST.CLAMP FCPS. CVD. 23.0 CM	246	DRESSING FORCEPS, ENGL. PATTERN, 15,0 CM	67
DOYEN AT INTEST.CLAMP FCPS. STR. 23.0 CM	246	DRESSING FORCEPS, FINE, CURVED, 10,5CM	65
DOYEN AT INTEST.CLAMP FCPS. STR.21,0 CM	246	DRESSING FORCEPS, FINE, CURVED, 11,5CM	65
DOYEN INTESTINAL CLAMP FCPS CVD 21.0 CM	245	DRESSING FORCEPS, FINE, CURVED, 13,0CM	65
DOYEN INTESTINAL CLAMP FCPS CVD 23.0 CM	245	DRESSING FORCEPS, FINE, CURVED, 14,5CM	65
DOYEN INTESTINAL CLAMP FCPS STR 21.0 CM	245	DRESSING FORCEPS, FINE, CURVED, 16,0CM	65
DOYEN INTESTINAL CLAMP FCPS STR 23.0 CM	245	DRESSING FORCEPS, FINE, CURVED, 18,0CM	65
DOYEN MYOMA SCREW 17.0 CM	279	DRESSING FORCEPS, FINE, CURVED, 20,0CM	65
DOYEN MYOMA SCREW 17.0CM	279	DRESSING FORCEPS, FINE, CURVED, 25,0CM	65
DOYEN PERIOST.RASPATORY CVD LEFT 17.0 CM	303	DRESSING FORCEPS, FINE, CURVED, 30,0CM	65
DOYEN PERIOST.RASPATORY CVD LEFT 17.0CM	303	DUBOIS CEPHALOTOMY SCS CVD BL/BL 27.0 CM	41
DOYEN PERIOST.RASPATORY CVD RIGHT 17.0CM	303	DUBOIS CEPHALOTOMY SCS STR BL/BL 27.0 CM	41
DOYEN PROBE 14.5 CM	214	DUEHRSEN, DRESSING FCPS., 20.0 CM	68
DOYEN RETRACTOR 50X85 MM 25.0 CM	178	DUEHRSEN TISSUE FCPS 1X2 TEETH 20.0 CM	75
DOYEN RETRACTOR 55X105 MM 28.0 CM	209	DUEHRSEN TISSUE FCPS 2X3 TEETH 20.0 CM	75
DOYEN RETRACTOR 55X105 MM 28.0 CM	209	DUEHRSEN TISSUE FCPS 3X4 TEETH 20.0 CM	75
DOYEN RETRACTOR 55X125 MM 28.0 CM	209	DUPLAY, UTERINE TENACULUM FORCEPS, 28,0 CM	273
DOYEN RETRACTOR 55X95 MM 28.0 CM	209	DURANTE TISSUE FCPS 16.0 CM	75
DOYEN VAG.SPECULUM SL.CONCAVE 115X35 MM	264	DURANTE TISSUE FORCEPS 14.5 CM	75
DOYEN VAG.SPECULUM SL.CONCAVE 115X45 MM	264	DURANTE TISSUE FORCEPS 20,0 CM	75
DOYEN VAG.SPECULUM SL.CONCAVE 115X60 MM	264	DUVAL INT.TISSUE FCPS LARGE 20.0 CM	245
DOYEN VAG.SPECULUM SL.CONCAVE 160X45 MM	264	DUVAL INT.TISSUE FCPS LARGE 23.0 CM	245
DOYEN VAG.SPECULUM SL.CONCAVE 160X60 MM	264	DUVAL INT.TISSUE FCPS SMALL 20.0 CM	245
DOYEN VAG.SPECULUM SL.CONCAVE 55X35 MM	264	DUVAL INT.TISSUE FCPS TC 20.0 CM	244
DOYEN VAG.SPECULUM SL.CONCAVE 55X45 MM	264	DUVAL INT.TISSUE FORCEPS SMALL 18,0 CM	245
DOYEN VAG.SPECULUM SL.CONCAVE 55X60 MM	264	DUVAL, INTESTINAL FORCEPS, FIG.1, 14.0 CM	75
DOYEN VAG.SPECULUM SL.CONCAVE 85X35 MM	264	DUVAL, INTESTINAL FORCEPS, FIG.2, 14.0 CM	75
DOYEN VAG.SPECULUM SL.CONCAVE 85X45 MM	264	EISELSBERG LIGATURE SCISSORS 11.0 CM	34
DOYEN VAG.SPECULUM SL.CONCAVE 85X60 MM	264	ELLIOT, OBSTETREICAL FORCEPS, 32,0 CM	290
DOYEN, POLYPUS AND OVUM FORCEPS, 20,5 CM	276	ELLIOT, OBSTETREICAL FORCEPS, 38,0 CM	290
DOYEN, VAGINAL SPECULA, 60X30 MM	268	EMMET FISTULA HOOK FIG.1 22.0 CM	279
DOYEN, VAGINAL SPECULA, 80X30 MM	268	EMMET FISTULA HOOK FIG.2 22.0 CM	279
DOYEN, VAGINAL SPECULA, MEDIUM CONCAVE, 115X35 MM	264	EMMET FISTULA HOOK FIG.3 22.0 CM	279
DOYEN, VAGINAL SPECULA, MEDIUM CONCAVE, 115X45 MM	264	EMMET FISTULA HOOK FIG.4 22.0 CM	279
DOYEN, VAGINAL SPECULA, MEDIUM CONCAVE, 115X60 MM	264	EMMET FISTULA HOOK FIG.5 22.0 CM	279
DOYEN, VAGINAL SPECULA, MEDIUM CONCAVE, 55X35 MM	264	ENDARTERECTOMY, DISSEC.-SCS., SUPERCUT, CURVED, BL/BL, 18.0 CM	56
DOYEN, VAGINAL SPECULA, MEDIUM CONCAVE, 55X45 MM	264	ENGL.MODEL TOWEL FORCEPS 9,0 CM	86
DOYEN, VAGINAL SPECULA, MEDIUM CONCAVE, 55X60 MM	264	ENTEROTOMY SCS FOR ANATOMY 21.0 CM	41
DOYEN, VAGINAL SPECULA, MEDIUM CONCAVE, 85X35 MM	264	ENTEROTOMY SCS. FOR ANATOMY 21.0 CM	41
DOYEN, VAGINAL SPECULA, MEDIUM CONCAVE, 85X45 MM	264	ENTEROTOMY SCS. FOR ANATOMY 21.0 CM	41
DOYEN, VAGINAL SPECULA, MEDIUM CONCAVE, 85X60 MM	264	EPISIOTOMY-SCISSORS 20,0 CM	43
DOYEN-STILLE, RETRACTOR, 105x30 MM, 22,0 CM	179	EPPENDORF CERV.BIOPSY+SPEC.FCPS 20,0 CM	287
DOYEN-STILLE, RETRACTOR, 120x52 MM, 22,0 CM	179	ESMARCH BANDAGE SCISSORS 20.0 CM	45
DOYEN-STILLE, RETRACTOR,90x28 MM, 22,0 CM	179	ESMARCH BANDAGE SCISSORS 22.0 CM	45
DRESSING FCPS MOD.USA GRACILE 13.0 CM	65	EXCHANGEABLE BLADE 100X70 MM	203
DRESSING FCPS MOD.USA GRACILE 14.5 CM	65	EXCHANGEABLE BLADE 38X62 MM	200
DRESSING FCPS MOD.USA GRACILE 15.5 CM	65	EXCHANGEABLE BLADE 38X80 MM	200
DRESSING FCPS MOD.USA GRACILE 18.0 CM	65	EXCHANGEABLE BLADE 50X58 MM	200
DRESSING FCPS MOD.USA GRACILE 20.0 CM	65	EXCHANGEABLE BLADE 60X80 MM	200
DRESSING FCPS MOD.USA GRACILE 25.0 CM	65	EXCHANGEABLE BLADE 60X80 MM	200
DRESSING FCPS., STANDARD, TC, 14,5 CM	82	EXCHANGEABLE BLADE 62X80 MM	200
DRESSING FCPS., STANDARD, TC, 18,0 CM	82	EXCHANGEABLE BLADE 62X80 MM	200
DRESSING FCPS., STANDARD, TC, 20,0 CM	82	EXCHANGEABLE BLADE 72X85 MM	200
DRESSING FCPS., STANDARD, TC, 25,0 CM	82	FALK LIGATURE NEEDLE LEFT 24.0 CM	150
DRESSING FORCEPS FINE 10,5CM	64	FALK LIGATURE NEEDLE RIGHT 24.0 CM	150
DRESSING FORCEPS FINE 11,5CM	64	FANSLER, ANOSCOPE, Ø 25 X 65 MM	254
DRESSING FORCEPS FINE 13,0CM	64	FANSLER, ANOSCOPE, Ø 29 X 65 MM	254
DRESSING FORCEPS FINE 14,5CM	64	FANSLER, ANOSCOPE, Ø 38 X 70 MM	254

FARABEUF PERIOSTEAL RASPTORY CVD 15.0CM	303	FRANZ, ABDOMINAL RETRACTOR, VALVE ONLY, 45X80 MM	208
FARABEUF PERIOSTEAL RASPTORY STR 15.0CM	302	FRANZ, ABDOMINAL RETRACTOR, VALVE ONLY, 50X65 MM	208
FARABEUF RETRACTOR SET FIG.1+2 12.0 CM	167	FRANZ, ABDOMINAL RETRACTOR, VALVE ONLY, 60X85 MM	208
FARABEUF, RETRACTOR SET FIG.1+2, 15.0 CM	167	FRAZIER BRAIN SUCTION TUBE CHARR 6/17CM	223
FARREL COTTON APPL.0.9 MM 12.0 CM ROUND	216	FRAZIER BRAIN SUCTION TUBE CHARR10/17CM	223
FARREL COTTON APPL.0.9 MM 14.0 CM ROUND	216	FRAZIER SUCTION TUBE CHARR 12/ 17.0CM	223
FARREL COTTON APPL.1.1 MM 16.5 CM ROUND	216	FRAZIER SUCTION TUBE CHARR 8/17CM	223
FARREL COTTON APPL.1.2 MM 18.0 CM ROUND	216	FRAZIER, DURAAND SKIN RETRACTOR, SHARP, 13.0 CM	158
FARREL COTTON APPL.TRIANGLE SERR.0,9 MM	216	FRITSCH RETRACTOR 45X40 MM 24.0 CM	178
FARREL COTTON APPL.TRIANGLE SERR.0.9 MM	216	FRITSCH RETRACTOR 45X50 MM 24.0 CM	178
FARREL COTTON APPL.TRIANGLE SERR.1,2 MM	216	FRITSCH RETRACTOR 45X60 MM 24.0 CM	178
FARREL COTTON APPL.TRIANGLE SERR.1.1 MM	216	FRITSCH RETRACTOR 45X75 MM 24.0 CM	178
FAURE PERIT.CLAMP-FCPS 1X2 T. 20.0 CM	119	FRITSCH RETRACTOR 65X85 MM 24.0 CM	178
FAURE PERIT.CLAMP-FCPS 1X2 T. 20.0 CM	119	GARLAND CLAMP FORCEPS 21.0 CM	121
FAURE, CERVICAL BIOPSY+SPEC FCPS 23.0 CM	287	GELPI RETRACTOR 14.0 CM	193
FAVALORO ARTERY SCISSORS 15.0 CM	38	GELPI RETRACTOR 19.0 CM	193
FEILCHENFELD SPLINTER FORCEPS 11,5 CM	78	GELPI-LOKTITE, RETRACTOR, 18.0 CM	193
FEILCHENFELD SPLINTER FORCEPS 7,5 CM	78	GEMINI, DISSECTING AND LIGATURE FCPS, CURVED, 14,0 CM	112
FEILCHENFELD SPLINTER FORCEPS 9,0 CM	78	GEMINI, DISSECTING AND LIGATURE FCPS, CURVED, 16,0 CM	112
FEIN COTTON APPLICATOR 28.0 CM	216	GEMINI, DISSECTING AND LIGATURE FCPS, CURVED, 18,0 CM	112
FERGUSSON OPERATING SCISSORS 16.5 CM	32	GEMINI, DISSECTING AND LIGATURE FCPS, CURVED, 20,0 CM	112
FERGUSSON OPERATING SCISSORS 18.0 CM	32	GEMINI, DISSECTING AND LIGATURE FCPS, CURVED, 23,0 CM	112
FERGUSSON ANGIOTRIBE CVD.16.0 CM	98	GEMINI, DISSECTING AND LIGATURE FCPS, CURVED, 25,0 CM	112
FERGUSSON ANGIOTRIBE CVD.20.0 CM	98	GEMINI, DISSECTING AND LIGATURE FCPS, CURVED, 28,0 CM	112
FERGUSSON ANGIOTRIBE STR.16.0 CM	98	GERALD DRESSING FORCEPS CVD 18.0 CM	67
FERGUSSON ANGIOTRIBE STR.20.0 CM	98	GERALD TISSUE FORCEPS CVD 1X2 T. 17.0 CM	73
FERGUSSON, GALL STONE SCOOPS, DOUBLE-ENDED, 21,5 CM	234	GERALD TISSUE FORCEPS STR 1X2 T 17.0 CM	73
FERGUSSON, SUCTION TUBE Ø 2.0 MM, CHARR. 6, 18.0 CM LUERATTACHMENT	223	GERALD, DRESSING FCPS, TC, 17.0 CM	83
FERGUSSON, SUCTION TUBE Ø 2.6MM, CHARR. 8, 18.0 CM LUERATTACHMENT	223	GERALD, DRESSING FORCEPS STRAIGHT, 18.0 CM	66
FERGUSSON, SUCTION TUBE Ø 3.3MM, CHARR. 10, 18.0 CM LUERATTACHMENT	223	GERALD, TISSUE FORCEPS, 1X2 TEETH, TC, 17.0 CM	83
FERGUSSON, SUCTION TUBE Ø 4.0MM, CHARR. 12, 18.0 CM LUERATTACHMENT	223	GILLIES NEEDLE HOLDER/SCSTC 16.0 CM	140
FIBRE OPTIC LIGHT CARRIER FOR ALAN PARKS	253	GILLIES TISSUE FCPS 1X2 TEETH 15.0 CM	72
FINE OPER.SCISSORS CVD SH/SH 11.0 CM ROUNDED SHANKS	29	GILLIES TISSUE FORCEPS 1X2 T.TC 15.0 CM	83
FINE OPER.SCISSORS STR SH/SH 11.0 CM ROUNDED SHANKS	29	GILLIES, DURAAND SKIN HOOK, FIG. 1 SHARP, 18.5 CM	158
FINE OPER.SCISSORS STR SH/SH 11.5 CM ROUNDED SHANKS	29	GILLIES, DURAAND SKIN HOOK, FIG. 2 SHARP, 18.5 CM	158
FINE OPERATING SCISSORS CURVED, SHARP/SHARP, 11.5 CM ROUND SHANKS	29	GIL-VERNET RETRACTOR 11 MM 24.0 CM	166
FINE OPERATING SCISSORS STRAIGHT, SHARP/SHARP, 12,0 CM	30	GIL-VERNET RETRACTOR 11 MM 24.5 CM	166
FINE OPERATING SCISSORS, CURVED, SHARP/SHARP, 12,0 CM	30	GIL-VERNET RETRACTOR 13 MM 24.0 CM	166
FINGER NAIL DRILL, DRILL ONLY	294	GIL-VERNET RETRACTOR 13 MM 24.5 CM	166
FINGER NAIL DRILL, DRILL ONLY	294	GIL-VERNET RETRACTOR 18 MM 24.0 CM	166
FINGER NAIL DRILL, DRILL ONLY	294	GIL-VERNET RETRACTOR 18 MM 24.5 CM	166
FINGER NAIL DRILL, WITH 4 DRILL POINTS	294	GIL-VERNET RETRACTOR 9 MM 24.0 CM	166
FINGER RING SAW MOD.MARTIN	296	GIL-VERNET RETRACTOR 9 MM 24.5 CM	166
FINGER RING SAW, BOX-LOCK	296	GIL-VERNET, RETRACTOR, 20 MM, 24,5 CM	166
FINOCCHIETTO ARTERY FORCEPS 24.0 CM	115	GIL-VERNET, RETRACTOR, 20 MM, 24,0 CM	166
FINOCCHIETTO NEEDLE HOLDER ANGLED 27.0CM	127	GIL-VERNET, RETRACTOR, 23 MM, 24,5 CM	166
FINOCCHIETTO NEEDLE HOLDER TC 27.0 CM	138	GIL-VERNET, RETRACTOR, 23 MM, 24,0 CM	166
FINOCCHIETTO RIB SPREADER 40X40X165	211	GLASSMAN, INTESTINAL CLAMP FORCEPS, 60° ANGLED, 23,0 CM	248
FINOCCHIETTO RIB SPREADER 45X65X200	211	GLASSMAN, INTESTINAL CLAMP FORCEPS, 90° ANGLED, 23,5 CM	248
FINOCCHIETTO RIB SPREADER 70X65X250	211	GLOVER ATRAUMA-BULLDOG CLAMP CURVED, 5,5 CM	96
FINOCCHIETTO-BABY RIB SPREADER 18X20/75	211	GLOVER ATRAUMA-BULLDOG CLAMP STR 6.0 CM	96
FINOCHIETTO LOBECT SCS CVD BL 27.0 CM	42	GLOVER ATRAUMA-BULLDOG CLAMP STRAIGHT 9.0CM	96
FINSEN RETRACTOR BL 2X3 PRONGS 5.0 CM	188	GLOVER ATRAUMA-BULLDOG CLAMP CVD 10.5CM	96
FINSEN RETRACTOR BL 3X4 PRONGS 7.0 CM	188	GLOVER ATRAUMA-BULLDOG CLAMP CVD 8.5 CM	96
FINSEN RETRACTOR SH 2X3 PRONGS 5.0 CM	188	GLOVER ATRAUMA-BULLDOG CLAMP STR 11.0CM	96
FINSEN RETRACTOR SH 3X4 PRONGS 7.0 CM	188	GOELT RETRACTOR 19.0 CM	169
FISTULA HOOK, 25,0 CM	279	GOMEL, MICRO-NEEDLE HOLDER, CURVED, 14,0 CM	130
FOERSTER SPONGE HOLDING NARROW CVD 25.0CM	90	GOMEL, MICRO-SCS., ROUND-HANDLE, 1 BLADE SERRATED, CURVED, 14,0 CM	59
FOERSTER SPONGE HOLDING NARROW STR 25.0CM	90	GOMEL, MICRO-SCS., ROUND-HANDLE, 1 BLADE SERRATED, CURVED, 16,0 CM	59
FOERSTER-BALLENGER CVD SERRATED 18.0 CM	90	GOOD TONSIL SCISSORS CVD 19.0 CM	36
FOERSTER-BALLENGER CVD SERRATED 25.0 CM	90	GOSSET ABDOMINAL RETRACTOR 100MM OPENING	201
FOERSTER-BALLENGER CVD SMOOTH 18.0 CM	90	GOSSET ABDOMINAL RETRACTOR 140MM OPENING	201
FOERSTER-BALLENGER CVD SMOOTH 25.0 CM	90	GOSSET ABDOMINAL RETRACTOR 160MM OPENING	201
FOERSTER-BALLENGER FCPS CURVED 20,0 CM	90	GOUGE, 10MM 13,5CM	304
FOERSTER-BALLENGER FCPS CVD SERR.20,0 CM	90	GOUGE, 12MM 13,5CM	304
FOERSTER-BALLENGER FCPS STRAIGHT 20,0 CM	90	GOUGE, 14MM 13,5CM	304
FOERSTER-BALLENGER FCPS STR.SERR.20,0 CM	90	GOUGE, 16MM 13,5CM	304
FOERSTER-BALLENGER STR SERRATED 18.0 CM	90	GOUGE, 8MM 13,5CM	304
FOERSTER-BALLENGER STR SERRATED 25.0 CM	90	GRAEFE DELICATE HOOK BLUNT 16,0 CM	158
FOERSTER-BALLENGER STR SMOOTH 18.0 CM	90	GRAEFE DELICATE HOOK SHARP 16,0 CM	158
FOERSTER-BALLENGER STR SMOOTH 25.0 CM	90	GRAEFE IRIS FCPS STRO.CVD 1X2 T. 10.0 CM	79
FOMON NASAL SCISSORS BLUNT 13,5 CM	33	GRAEFE IRIS FORCEPS SL.CVD 1X2 T. 10.0CM	79
FOMON, DISSECTING SCISSORS CURVED, 13,5 CM	19	GRAEFE IRIS FORCEPS SL.CVD SERR. 10.0 CM	79
FOMON, NASAL SCS., SUPER CUT, BL/BL, 14,5 CM	58	GRAEFE IRIS FORCEPS STR 1X2 TEETH 10.0CM	79
FORCEPS FINE PATTERN STR 10.5 CM	65	GRAEFE IRIS FORCEPS STR SERR. 10.0 CM	79
FORCEPS FINE PATTERN STR 11.5 CM	65	GRAEFE IRIS FORCEPS STRO.CVD SERR 10.0CM	79
FORCEPS FINE PATTERN STR 13.0 CM	65	GRAVE VAG.SPECULUM 115 X 35 MM	260
FORCEPS FINE PATTERN STR 14.5 CM	65	GRAVE VAG.SPECULUM 75 X 20 MM	260
FORCEPS FINE PATTERN STR 16.0 CM	65	GRAVE VAG.SPECULUM 95 X 35 MM	260
FORCEPS FINE PATTERN STR 18.0 CM	65	GRAY GALL DUCT CLAMP, S' 1X2 T 22.0 CM	115
FORCEPS FINE PATTERN STR 20.0 CM	65	GRAY GALL DUCT CLAMP, S' 1X2 T. 23.0 CM	115
FORCEPS FINE PATTERN STR 25.0 CM	65	GRAY GALL DUCT CLAMP S-SHAPED 22.0 CM	115
FORCEPS FINE PATTERN STR 30.0 CM	65	GRAY GALL DUCT CLAMP S-SHAPED 23.0 CM	115
FOX, LUPUS CURETTE, Ø 3 MM, 14,0 CM	295	GREEN-ARMYTAGE, CAESAREAN SECTION HAEMOSTATIC FORCEPS, 21,0 CM	291
FOX, LUPUS CURETTE, Ø 4 MM, 14,0 CM	295	GROOVED DIRECTOR 11.5 CM	215
FOX, LUPUS CURETTE, Ø 5 MM, 14,0 CM	295	GROOVED DIRECTOR 13.0 CM	215
FOX, LUPUS CURETTE, Ø 6 MM, 14,0 CM	295	GROOVED DIRECTOR 14.5 CM	215
FRANZ, ABDOMINAL RETRACTOR, COMPLETE	208	GROOVED DIRECTOR 16.0 CM	215
FRANZ, ABDOMINAL RETRACTOR, FRAME ONLY, 300X300 MM	208	GROOVED DIRECTOR 18.0 CM	215
FRANZ, ABDOMINAL RETRACTOR, VALVE ONLY, 38X60 MM	208	GROOVED DIRECTOR 20.0 CM	215

GROOVED DIRECTOR WITH PROBE 11.0 CM	215	HEGAR UT.DILATOR W.SLOPED HDL.15,0 MM	270
GROSS-MAIER DRESSING FCPS CURVED 20,0 CM	90	HEGAR UT.DILATOR W.SLOPED HDL.15.5 MM	270
GROSS-MAIER DRESSING FCPS CURVED 22,0 CM	90	HEGAR UT.DILATOR W.SLOPED HDL.16,0 MM	270
GROSS-MAIER DRESSING FCPS CURVED 25,0 CM	90	HEGAR UT.DILATOR W.SLOPED HDL.16.5 MM	270
GROSS-MAIER DRESSING FCPS CURVED 27,0 CM	90	HEGAR UT.DILATOR W.SLOPED HDL.17,0 MM	270
GROSS-MAIER DRESSING FCPS STR.20,0 CM	90	HEGAR UT.DILATOR W.SLOPED HDL.17.5 MM	270
GROSS-MAIER DRESSING FCPS STR.22,0 CM	90	HEGAR UT.DILATOR W.SLOPED HDL.18,0 MM	270
GROSS-MAIER DRESSING FCPS STR.25,0 CM	90	HEGAR UT.DILATOR W.SLOPED HDL.19,0 MM	270
GROSS-MAIER DRESSING FCPS STR.27,0 CM	90	HEGAR UT.DILATOR W.SLOPED HDL.2.5 MM	270
GUTHRIE DELICATE HOOK FIG.1 16,0 CM	159	HEGAR UT.DILATOR W.SLOPED HDL.20 MM	270
GUTHRIE DELICATE HOOK FIG.2 16,0 CM	159	HEGAR UT.DILATOR W.SLOPED HDL.21 MM	270
GUYON KIDNEY PED.CLAMP FCPS.23,0 CM	116	HEGAR UT.DILATOR W.SLOPED HDL.22 MM	270
GUYON KIDNEY PEDICLE CLAMP FCPS.20,0 CM	116	HEGAR UT.DILATOR W.SLOPED HDL.23 MM	270
GUYON KIDNEY PEDICLE CLAMP FCPS.22,0 CM	116	HEGAR UT.DILATOR W.SLOPED HDL.24 MM	270
GUYON KIDNEY PEDICLE CLAMP FCPS.24,0 CM	116	HEGAR UT.DILATOR W.SLOPED HDL.25 MM	270
GUYON, ATRAUMATIC GALL DUCT AND KIDNEY PEDICLE CLAMPS, 23,0 CM	116	HEGAR UT.DILATOR W.SLOPED HDL.26 MM	270
GUYON, ATRAUMATIC GALL DUCT AND KIDNEY PEDICLE CLAMPS, 24,0 CM	116	HEGAR UT.DILATOR W.SLOPED HDL.3.5 MM	270
HABERER, ABDOMINAL SPATULA, 280 x 25/30 MM, MALLEABLE	210	HEGAR UT.DILATOR W.SLOPED HDL.4.5 MM	270
HABERER, ABDOMINAL SPATULA, 280 x 40/50 MM, MALLEABLE	210	HEGAR UT.DILATOR W.SLOPED HDL.5.5 MM	270
HABERER, ABDOMINAL SPATULA, 300 x 37/45 MM, MALLEABLE	210	HEGAR UT.DILATOR W.SLOPED HDL.6.5 MM	270
HALLE NASAL SCISSORS CURVED 19,0 CM	33	HEGAR UT.DILATOR W.SLOPED HDL.7.5 MM	270
HALLE, BONE CURETTE MALLEABLE, FIG. 00, 21,0 CM	299	HEGAR UT.DILATOR W.SLOPED HDL.8.5 MM	270
HALLE, BONE CURETTE, MALLEABLE, FIG. 0, 21,0 CM	299	HEGAR UT.DILATOR W.SLOPED HDL.9.5 MM	270
HALLE, BONE CURETTE, MALLEABLE, FIG. 1, 21,0 CM	299	HEGAR UTERINE DILATORS 1.0/2.0MM	271
HALSEY NEEDLE HOLDER 13,0 CM	124	HEGAR UTERINE DILATORS 11.0/12.0MM	271
HALSEY NEEDLE HOLDER SMOOTH JAWS 13,0 CM	124	HEGAR UTERINE DILATORS 13.0/14.0MM	271
HALSEY NEEDLE HOLDER TC 13,0 CM	134	HEGAR UTERINE DILATORS 15.0/16.0MM	271
HALSEY NEEDLE HOLDER TC SMOOTH 13,0CM	134	HEGAR UTERINE DILATORS 17.0/18.0MM	271
HALSTED ARTERY FCPS.CVD 18,0 CM	100	HEGAR UTERINE DILATORS 19.0/20.0MM	271
HALSTED ARTERY FCPS.CVD 1X2 18,0 CM	100	HEGAR UTERINE DILATORS 21.0/22.0MM	271
HALSTED ARTERY FCPS.CVD 1X2 21,0 CM	100	HEGAR UTERINE DILATORS 23.0/24.0MM	271
HALSTED ARTERY FCPS.CVD 21,0 CM	100	HEGAR UTERINE DILATORS 25.0/26.0MM	271
HALSTED ARTERY FCPS.STR 18,0 CM	100	HEGAR UTERINE DILATORS 3.0/4.0MM	271
HALSTED ARTERY FCPS.STR 1X2 18,0 CM	100	HEGAR UTERINE DILATORS 5.0/6.0MM	271
HALSTED ARTERY FCPS.STR 1X2 21,0 CM	100	HEGAR UTERINE DILATORS 7.0/8.0MM	271
HALSTED ARTERY FCPS.STR 21,0 CM	100	HEGAR UTERINE DILATORS 9.0/10.0MM	271
HALSTED-MOSQUITO ART.FCPS CVD 14,0 CM	100	HEGAR, NEEDLE HOLDER WITH TC, 20,0 CM	139
HALSTED-MOSQUITO ART.FCPS STR 14,0 CM	100	HEGAR, NEEDLE HOLDER WITH TC, 24,0 CM	139
HALSTED-MOSQUITO ART.FCPS.1X2 CVD 14,0CM	100	HEGAR, UTERINE-DILATOR, SET OF 13 PCS., Ø1,0/2,0 - 25,0/26,0 MM	271
HALSTED-MOSQUITO ART.FCPS.1X2 STR 12,5CM	100	HEGAR, UTERINE-DILATOR, SET OF 8 PCS., Ø 3/4-17/18MM	271
HALSTED-MOSQUITO FCPS.1X2 CVD 12,5CM	100	HEGAR-BAUMGARTNER, NEEDLE HOLDER, WITH TC,12,5 CM	133
HALSTED-MOSQUITO FCPS.1X2 STR 14,0CM	100	HEGAR-BAUMGARTNER, NEEDLE HOLDER, WITH TC,14,0 CM	133
HALSTED-MOSQUITO, ARTERY FORCEPS CURVED, 12,5 CM	100	HEGAR-BAUMGARTNER, NEEDLE HOLDER,14,0CM	124
HALSTED-MOSQUITO, ARTERY FORCEPS STRAIGHT, 12,5 CM	100	HEGAR-VASCULAR, NEEDLE HOLDER WITH TC, 14,0 CM	138
HANDBRUSH, STERILIZABLE	311	HEGAR-VASCULAR, NEEDLE HOLDER WITH TC, 18,0 CM	138
HANK SET OF 6 DILATORS 4.5/5-9.5/10MM	271	HEGAR-VASCULAR, NEEDLE HOLDER WITH TC, 20,0 CM	138
HANK UTERINE DILATOR FIG.19/20,9.5/10MM	271	HEGAR-VASCULAR, NEEDLE HOLDER WITH TC, 23,0 CM	138
HANK UTERINE DILATORS FIG.11/12,5,5/6MM	271	HEGEMANN-DIETHRICH VASC.SCS 125DEG19,0CM	38
HANK UTERINE DILATORS FIG.13/14,6,5/7MM	271	HEGEMANN-DIETHRICH, VASCULAR SCISSORS, 125°, 19,0 CM	37
HANK UTERINE DILATORS FIG.15/16,7,5/8MM	271	HEGEMANN-DIETHRICH, VASCULAR SCISSORS, 25°, 19,0 CM	37
HANK UTERINE DILATORS FIG.17/18,8,5/9MM	271	HEGEMANN-DIETHRICH, VASCULAR SCISSORS, 45°, 19,0 CM	37
HANK UTERINE DILATORS FIG.9/10,4,5/5MM	271	HEGEMANN-DIETHRICH, VASCULAR SCISSORS, 60°, 19,0 CM	37
HARRINGTON RETRACTOR 127X40 MM 32,0 CM	182	HEGEMANN-DIETHRICH, VASCULAR SCISSORS, 90°, 19,0 CM	37
HARRINGTON RETRACTOR 127X62 MM 32,0 CM	182	HEGENBARTH SUTURE FORCEPS 12,5 CM	154
HARTMANN FORCEPS STR 10,0 CM	99	HEISS ARTERY FORCEPS STR. 20,0 CM FIG.1	107
HARTMANN, ARTERY FORCEPS CURVED, 10,0 CM	99	HEISS ARTERY FORCEPS STRONG CURVE 20,0CM	107
HAYES, SIGMOID ANASTOMOSIS FORCEPS, 26,0 CM	251	HEISS FORCEPS SLIGHTLY CVD 20,0CM	107
HAYES, SIGMOID ANASTOMOSIS FORCEPS, 28,0 CM	251	HENLEY EXCHANGEABLE BLADE 16X19 MM	197
HEANEY CLAMP-FORCEPS 1 TOOTH 21,0 CM	122	HENLEY EXCHANGEABLE BLADE 16X25 MM	197
HEANEY CLAMP-FORCEPS 1 TOOTH 23,0 CM	122	HENLEY EXCHANGEABLE BLADES 16X32 MM	197
HEANEY CLAMP-FORCEPS 2 TEETH 21,5 CM	122	HENLEY, SELF-RETAINING RETRACTOR, ONLY BLUNT, 3 X 4 TEETH, 16,0 CM	197
HEANEY CLAMP-FORCEPS 2 TEETH 23,0 CM	122	HENLEY, SELF-RETAINING RETRACTOR, ONLY SHARP, 3 X 4 TEETH, 16,0 CM	197
HEANEY CLAMP-FORCEPS LIGHT JAWS 21,0 CM	121	HEPP SCHEIDEL, MICRO-NEEDLE HOLDER WITH TC, 18,0 CM	144
HEANEY NEEDLE HOLDER CVD 21,0 CM	127	HEPP/SCHIEDL, SUCTION TUBE, W. IRRIGATION, 22,5 CM	223
HEANEY-BALLANTINE CLAMP FCPS.CVD 21,0 CM	121	HEPP-SCHIEDL, MICRO-SCS., ROUND-HANDLE, CURVED, 14,0 CM	59
HEANEY-BALLANTINE CLAMP FCPS.STR 21,0 CM	121	HEPP-SCHIEDL, MICRO-SCS., ROUND-HANDLE, CURVED, 16,0 CM	59
HEANEY-KANTER CLAMP FCPS. 2 TEETH21,0 CM	121	HERRICK KIDNEY PEDICLE CLAMP FCPS 23,0CM	117
HEATH LIGATURE SCISSORS 15,0 CM	34	HESS BULLDOG CLAMPS, 2,0 cm	94
HEGAR DILATORS, SET, Ø 1-26 MM, W. METAL CASE	270	HESS, BULLDOG CLAMPS, 3,0 cm	94
HEGAR DILATORS, SET, Ø 4-17 MM, W. METAL CASE	270	HESSBERG LIGATURE NEEDLE 15,0 CM	149
HEGAR UT DILATOR W.SLOPED HDL 7,0 MM	270	HEYMANN NASAL SCISSORS BLUNT 18,0 CM	35
HEGAR UT.DILATOR W.SLOPED HDL 1,0 MM	270	HEYWOOD-SMITH, HAEMORRHOIDAL FORCEPS 25,0 CM	276
HEGAR UT.DILATOR W.SLOPED HDL 11,0 MM	270	HIRSCHMANN ANOSCOPE W.OBTURATOR 19X65 MM	253
HEGAR UT.DILATOR W.SLOPED HDL 2,0 MM	270	HIRSCHMANN ANOSCOPE W.OBTURATOR 22X65 MM	253
HEGAR UT.DILATOR W.SLOPED HDL 3,0 MM	270	HIRSCHMANN ANUSCOPE W.OBTURATOR 16X65 MM	253
HEGAR UT.DILATOR W.SLOPED HDL 4,0 MM	270	HIRSCHMANN, ANOSCOPE W. OBTURATOR, Ø 22 X 130 MM	253
HEGAR UT.DILATOR W.SLOPED HDL 5,0 MM	270	HOSEMANN, ARTERY FORCEPS, 1X2 TEETH, STRAIGHT, 21,0 CM	114
HEGAR UT.DILATOR W.SLOPED HDL 6,0 MM	270	HOSEMANN, ARTERY FORCEPS, STRAIGHT, 21,0 CM	114
HEGAR UT.DILATOR W.SLOPED HDL 8,0 MM	270	HUMBY, DERMATOMES, 35,0 CM	11
HEGAR UT.DILATOR W.SLOPED HDL 9,0 MM	270	HUMBY, DERMATOMES, SPARE BLADE	11
HEGAR UT.DILATOR W.SLOPED HDL. 1.5 MM	270	HUNTER SPLINTER FORCEPS CVD 10,5 CM	78
HEGAR UT.DILATOR W.SLOPED HDL.10,0 MM	270	HUNTER SPLINTER FORCEPS STR 10,5 CM	78
HEGAR UT.DILATOR W.SLOPED HDL.10,5 MM	270	HURD LIGATURE NEEDLE LEFT 21,0 CM	150
HEGAR UT.DILATOR W.SLOPED HDL.11,5 MM	270	HURD LIGATURE NEEDLE RIGHT 21,0 CM	150
HEGAR UT.DILATOR W.SLOPED HDL.12,0 MM	270	HURWITZ, TROCAR, Ø 12,3 MM	218
HEGAR UT.DILATOR W.SLOPED HDL.12,5 MM	270	HURWITZ, TROCAR, Ø 7,3 MM	218
HEGAR UT.DILATOR W.SLOPED HDL.13,0 MM	270	HURWITZ, TROCAR, Ø 8,7 MM	218
HEGAR UT.DILATOR W.SLOPED HDL.13,5 MM	270	HYSTEREKTOMY, DISSEC.-SCS. TC, S-SHAPED, 25,5 CM	51
HEGAR UT.DILATOR W.SLOPED HDL.14,0 MM	270	HYSTEREKTOMY, DISSEC.-SCS. TC, S-SHAPED, 25,5 CM	51
HEGAR UT.DILATOR W.SLOPED HDL.14,5 MM	270	INCISION SCISSORS 13,0 CM	32

INCISION SCISSORS 14,5 CM	32	KALLMORGEN, VAGINAL SPECULA, FIG. 2, SET, 90 x 40 MM	265
INCISION SCISSORS 15,5 CM	32	KALLMORGEN, VAGINAL SPECULA, FIG. 2, 90 x 40 MM	265
INSTRUMENT BOXES, LID WITH KNOB, 200X150X25 MM	310	KALT MICRO-NEEDLE HOLDER TC 14.0 CM	133
INSTRUMENT BOXES, LID WITH KNOB, 220X170X50 MM	310	KANTROWITZ DISS.AND LIG.FCPS. CVD 20,0CM	112
INSTRUMENT BOXES, LID WITH KNOB, 260X180X30 MM	310	KANTROWITZ DISS.AND LIG.FCPS. CVD 24,0CM	112
INSTRUMENT BOXES, LID WITH KNOB, 280X200X50 MM	310	KANTROWITZ DISS.AND LIG.FCPS. CVD 28,0CM	112
INSTRUMENT BOXES, LID WITH KNOB, 300X220X30 MM	310	KAYE FACE LIFT, DISSEC.-SCS., SUPERCUT, CURVED, BL/BL, 15,0 CM	56
INSTRUMENT BOXES, LID WITH KNOB, 320X240X50 MM	310	KAYE FACE LIFT, DISSEC.-SCS., SUPERCUT, CURVED, BL/BL, 19,0 CM	56
INSTRUMENT BOXES, LID WITH KNOB, 350X220X40 MM	310	KELLY FISTULA SCISSORS CURVED 16,0 CM	41
INSTRUMENT BOXES, LID WITH KNOB, 370X270X50 MM	310	KELLY FISTULA SCISSORS CURVED 18,0 CM	41
INSTRUMENT BOXES, LID WITH KNOB, 420X320X50 MM	310	KELLY FISTULA SCISSORS STRAIGHT 16,0 CM	40
INSULINE SYRINGE, LUER, 1 ML	227	KELLY FISTULA SCISSORS STRAIGHT 18,0 CM	40
INSULINE SYRINGE, LUER, 2 ML	227	KELLY FORCEPS CURVED 14,0 CM	101
IOWA TENACULUM FCPS.FAMNION BLADDER 26	275	KELLY FORCEPS STRAIGHT 14,0 CM	101
IOWA, SUCTION TUBE, 14,0 CM	224	KELLY POLYPUS FORCEPS 32,0 CM	276
IRIS SCISSOR CVD. SH/SH 11,5 CM SC	57	KELLY PROCTOSCOPE W.OBTURATOR 22X140 MM	253
IRIS SCISSOR STR. SH/SH 11,5 CM SC	57	KELLY PROCTOSCOPE W.OBTURATOR 22X200 MM	253
IRIS SCISSORS ANGLED SH/SH 11,5 CM	29	KELLY PROCTOSCOPE W.OBTURATOR 22X50 MM	253
IRIS SCISSORS CVD SH/SH 10,5 CM	28	KELLY PROCTOSCOPE W.OBTURATOR 22X50 MM	253
IRIS SCISSORS CVD SH/SH 11,5 CM	28	KELLY PROCTOSCOPE W.OBTURATOR 22X100 MM	253
IRIS SCISSORS CVD SH/SH 9,0 CM	28	KELLY RETRACTOR 160X38 MM 27,0 CM	180
IRIS SCISSORS LATERALLY CVD SH/SH 11,5CM	29	KELLY RETRACTOR 160X57 MM 27,0 CM	180
IRIS SCISSORS STR SH/SH 10,5 CM	28	KELLY RETRACTOR 190X38 MM 27,0 CM	180
IRIS SCISSORS STR SH/SH 11,5 CM	28	KELLY RETRACTOR 190X57 MM 27,0 CM	180
IRIS SCISSORS STR SH/SH 9,0 CM	28	KELLY, DISSECTING AND LIGATURE FCPS., 19,0 CM	111
IRIS, FINE SCISSORS, CURVED, WITH TC-INSERTS, 11,5 CM	55	KELLY, DISSECTING AND LIGATURE FCPS., 19,0 CM	111
IRIS, SCISSORS, WITH TC-INSERTS STRAIGHT, POINTED, 11,5 CM	55	KELLY, DISSECTING AND LIGATURE FCPS., 19,0 CM	111
ISRAEL RETR. 4 PRONGS 40X40 MM 25,0 CM	173	KELLY, DISSECTING AND LIGATURE FCPS., 22,0 CM	111
ISRAEL RETR. 6 PRONGS 50X60 MM 25,0 CM	173	KELLY, DISSECTING AND LIGATURE FCPS., 22,0 CM	111
ISRAEL RETR. 6 PRONGS 70X70MM 25,0 CM	173	KELLY, DISSECTING AND LIGATURE FCPS., 22,0 CM	111
ISRAEL RETR.5 PRONGS 45X50 MM 25,0 CM	173	KELLY, DISSECTING AND LIGATURE FCPS., 24,0 CM	111
IVES FANSLER, ANOSCOPE, Ø 22 MM	254	KELLY, DISSECTING AND LIGATURE FCPS., 24,0 CM	111
IVES FANSLER, ANOSCOPE, W. COLD LIGHT CARRIER, Ø 22 MM	254	KELLY, DISSECTING AND LIGATURE FCPS., 24,0 CM	111
JABALEY, FINE OP.-SCS., SUPERCUT, STRAIGHT, SH/SH, 13,0 CM	56	KELLY-RANKIN ARTERY FORCEPS CVD 16,0 CM	101
JACKSON BURROWS, SELF-RETAINING RETRACTOR, BLUNT, 17,5 CM	196	KELLY-RANKIN, HAEMOSTATIC FORCEPS STRAIGHT, 16,0 CM	101
JACKSON, VAGINAL SPECULA, FIG. 1, 75 x 38 MM	265	KEVORKIAN, BIOPSY CURETTE 30,0CM	278
JACKSON, VAGINAL SPECULA, FIG. 2, 90 x 38 MM	265	KEVORKIAN, BIOPSY CURETTE, 30,0 CM	278
JACKSON, VAGINAL SPECULA, FIG. 3, 100 x 38 MM	265	KEVORKIAN, BIOPSY CURETTE, 30,0 CM	278
JACOBI LIGATURE NEEDLE 14,0 CM	149	KEVORKIAN-PACIFIC CERVICAL BIOPSY FCPS	288
JACOBS TENAC.FCPS SIDEW.CVD 2X2T. 21,0CM	274	KEVORKIAN-YOUNGE, BIOPSY FORCEPS; 25,4 CM SHAFT, 3 MM X 8 MM BITE	287
JACOBS, UTERINE TENACULUM FORCEPS STRAIGHT, 2 X 2 TEETH, 21,0 CM	274	KEYES, DERMAL PUNCH, Ø 2 MM, 12,0 CM	294
JAMISON, DISSEC.-SCS., SUPERCUT, STRAIGHT, BL/BL, 15,0 CM	57	KEYES, DERMAL PUNCH, Ø 3 MM, 12,0 CM	294
JAMISON, DISSEC.-SCS., SUPERCUT, STRAIGHT, BL/BL, 18,0 CM	57	KEYES, DERMAL PUNCH, Ø 4 MM, 12,0 CM	294
JAMISON, NEEDLE HOLDER, 23,5 CM	127	KEYES, DERMAL PUNCH, Ø 5 MM, 12,0 CM	294
JANET, WOUND A. BLADDER SYRINGE, 100 ML	228	KEYES, DERMAL PUNCH, Ø 6 MM, 12,0 CM	294
JANET, WOUND A. BLADDER SYRINGE, 150 ML	228	KEYES, DERMAL PUNCH, Ø 7 MM, 12,0 CM	294
JANET, WOUND A. BLADDER SYRINGE, 200 ML	228	KEYES, DERMAL PUNCH, Ø 8 MM, 12,0 CM	294
JANET, WOUND A. BLADDER SYRINGE, 50 ML	228	KEYES, DERMAL PUNCHES, SET, W. 6 EXCHANGEABLE WORKING PARTS	294
JANSEN BONE CURETTES CURVED 15,0 CM	300	KIDNEY TRAY, 250 MM STAINLESS STEEL 18/10	309
JANSEN BONE CURETTES STRAIGHT 16,0 CM	300	KIDNEY TRAY, 170 MM STAINLESS STEEL 18/10	309
JANSEN RETRACTOR BLUNT 3X3 PRONGS 10,0CM	188	KIDNEY TRAY, 275 MM STAINLESS STEEL, 18/10	309
JANSEN RETRACTOR SHARP 3X3 PROMGS 10,0CM	188	KIELLAND, OBSTETRECIAL FORCEPS, 41,0 CM	290
JAR, Ø 100 x 175 MM	309	KIELLAND-LUIKART, OBSTETRICAL FORCEPS, 40,0 CM	290
JAR, Ø 100 x 200 MM	309	KILNER PLASTIC SURGERY SCS CVD 15,0 CM	26
JAR, Ø 75 x 130 MM	309	KILNER PLASTIC SURGERY SCS CVD 18,0 CM	26
JAR, Ø 75 x 175 MM	309	KILNER PLASTIC SURGERY SCS CVD 20,0 CM	26
JARCHO, UTERINE TENACULUM FORCEPS, 20,0 CM	273	KILNER PLASTIC SURGERY SCS STR 12,0 CM	26
JEWELER'S FORCEPS NO.3 12,0 CM	80	KILNER PLASTIC SURGERY SCS STR 15,0 CM	26
JEWELER'S FORCEPS NO.4 11,0 CM	80	KILNER PLASTIC SURGERY SCS STR 18,0 CM	26
JEWELER'S FORCEPS NO.5 11,0 CM	80	KILNER PLASTIC SURGERY SCS STR 20,0 CM	26
JEWELER'S FORCEPS NO.7 11,0 CM	80	KILNER, PLASTIC SURGERY SCS CVD 12,0 CM	26
JOBSON-HORNE COTTON APPLICATOR 18,0 CM	216	KILNER, SKIN HOOK, SHARP, 15,0 CM	158
JOHNS HOPKINS BULLDOG CLAMP STR 9,0 CM	94	KIRSCHNER ABDOMINAL RETRACTOR COMPLETE	206
JOHNS HOPKINS BULLDOG CLAMPS STR 4,0 CM	94	KIRSCHNER LIGATURE CONDUCTOR 25,5 CM	153
JOHNS-HOPKINS ARTERY FCPS CVD 20,0 CM	108	KIRSCHNER LIGATURE CONDUCTOR 28,0 CM	153
JOHNS-HOPKINS BULLDOG CLAMP CVD 4,0 CM	94	KIRSCHNER, ABDOMINAL RETRACTOR W. FOLDING FRAME, COMPLETE	206
JOHNS-HOPKINS BULLDOG CLAMP CVD 5,0 CM	94	KIRSCHNER, ABDOMINAL RETRACTOR W. OVAL FRAME, COMPLETE	207
JOHNS-HOPKINS BULLDOG CLAMP CVD 6,5 CM	94	KIRSCHNER, ABDOMINAL RETRACTOR, FOLDING FRAME ONLY, 255X255 MM	206
JOHNS-HOPKINS BULLDOG CLAMP CVD 7,5 CM	94	KIRSCHNER, ABDOMINAL RETRACTOR, FRAME ONLY, 250X250 MM	206
JOHNS-HOPKINS BULLDOG CLAMP CVD 9,0 CM	94	KIRSCHNER, ABDOMINAL RETRACTOR, FRAME ONLY, 300X320 MM	206
JOHNS-HOPKINS BULLDOG CLAMP STR 5,0 CM	94	KIRSCHNER, ABDOMINAL RETRACTOR, FRAME ONLY, 300X380 MM	206
JOHNS-HOPKINS BULLDOG CLAMP STR 6,5 CM	94	KIRSCHNER, ABDOMINAL RETRACTOR, VALVE ONLY, 105X38 MM	207
JOHNS-HOPKINS BULLDOG CLAMP STR 7,5 CM	94	KIRSCHNER, ABDOMINAL RETRACTOR, VALVE ONLY, 43X55 MM	206
JOHNSON, NEEDLE HOLDER, 27,0 CM	127	KIRSCHNER, ABDOMINAL RETRACTOR, VALVE ONLY, 50X65 MM	206
JOLL (FRIEDMAN), VAGINAL-SELF-RETAINING RETRACTOR, SHARP, 15,5 CM	196	KIRSCHNER, ABDOMINAL RETRACTOR, VALVE ONLY, 60X82 MM	207
JONES TOWEL FORCEPS 5,0 CM	86	KIRSCHNER, ABDOMINAL RETRACTOR, VALVE ONLY, 80X90 MM	206
JONES TOWEL FORCEPS 7,0 CM	86	KIRSCHNER, ABDOMINAL RETRACTOR, VALVE ONLY, 90X65 MM	206
JONES TOWEL FORCEPS 9,0 CM	86	KIRSCHNER, ABDOMINAL RETRACTOR, VALVE ONLY, 98X50 MM	207
JONES, TOWEL FORCEPS, WITH TUBE HOLDER, 9,0 CM	86	KIRSCHNER, ABDOMINAL RETRACTOR, VALVE ONLY, 98X95 MM	206
JOSEPH PLASTIC SURGERY SCS CVD 14,0 CM	27	KIRSCHNER-BALFOUR, ABDOMINAL RETRACTOR, VALVE ONLY, 83X82 MM	207
JOSEPH PLASTIC SURGERY SCS STR. 14,0 CM	27	KIRSTEIN, TONSIL SCISSORS, SERRATED, BLUNT/BLUNT, 18,0 CM	35
JUDD-ALLIS INT.TISSUE FCPS 3X4 T.15,0 CM	243	KLEINERT-KUTZ DELICATE HOOK FIG.1 16,0CM	158
JUDD-ALLIS INT.TISSUE FCPS 3X4 T.19,0 CM	243	KLEINERT-KUTZ DELICATE HOOK FIG.2 16,0CM	158
JUDD-MASSON, BLADDER RETRACTOR WITH CENTRAL VALVE	237	KLEINERT-KUTZ DELICATE HOOK FIG.3 16,0CM	158
KAHN, UTERINE TENACULUM FORCEPS, 24,0 CM	273	KLIMA-ROSSEGGER, STERNAL PUNCTURE CANNULA Ø 1,6 X 40 MM	225
KALLMORGEN, VAGINAL RETRACTOR, FIG. 1, 75 x 33 MM	265	KLINKENBERGH-LOTH ARTERY SCISSORS 23,0CM	39
KALLMORGEN, VAGINAL RETRACTOR, FIG. 2, 95 x 33 MM	265	KNAPP DELICATE HOOK SHARP 13,0 CM	160
KALLMORGEN, VAGINAL SPECULA, 17,0 CM, 75 x 39 MM	265	KNAPP, DELICATE HOOK, 1 X 4 TEETH, BLUNT, 13,0 CM	160
KALLMORGEN, VAGINAL SPECULA, FIG. 1, 70 X 40 MM	265	KNOT TIERS 23,0 CM	154
KALLMORGEN, VAGINAL SPECULA, FIG. 1, SET, 70 x 40 MM	265	KNOWLES SCISSORS FOR FINGERS STR 14,0 CM	45

KNUTSON CIRCUMCISION INSTRUM.	240	KRISTELLER, VAGINAL SPECULA, 105X28MM,FIG.2	262
KOCHER AT INTEST.CLAMP FCPS. CVD.25,0 CM	247	KRISTELLER, VAGINAL SPECULA, 110X27MM,FIG.1	262
KOCHER AT INTEST.CLAMP FCPS. STR.22,0 CM	247	KRISTELLER, VAGINAL SPECULA, 115X23MM,FIG.1	262
KOCHER AT INTEST.CLAMP FCPS.CVD. 22,0 CM	247	KRISTELLER, VAGINAL SPECULA, 115X29MM,FIG.3	262
KOCHER AT INTEST.CLAMP FCPS.CVD. 28,0 CM	247	KRISTELLER, VAGINAL SPECULA, 105X18MM, FIG.00	263
KOCHER AT INTEST.CLAMP FCPS.STR. 25,0 CM	247	KRISTELLER, VAGINAL SPECULA, 105X21MM, FIG.0	263
KOCHER AT INTEST.CLAMP FCPS.STR. 28,0 CM	247	KRISTELLER, VAGINAL SPECULA, 105X26MM, FIG.1	262
KOCHER BLADDER RETRACTOR 67 MM 26,0 CM	239	KRISTELLER, VAGINAL SPECULA, 105X33MM, FIG.3	262
KOCHER INT. CLAMP FCPS.STR.ELAST.22,0 CM	246	KRISTELLER, VAGINAL SPECULA, 110X14MM, FIG.00	263
KOCHER INT.CLAMP FCPS CVD ELASTIC 25,0CM	246	KRISTELLER, VAGINAL SPECULA, 110X17MM, FIG.0	263
KOCHER INT.CLAMP FCPS STR. ELAST.28,0 CM	246	KRISTELLER, VAGINAL SPECULA, 110X30MM, FIG.2	262
KOCHER INT.CLAMP FCPS. CVD.ELAST.22,0 CM	246	KRISTELLER, VAGINAL SPECULA, 110X36MM, FIG.3	262
KOCHER INT.CLAMP FCPS. CVD.ELAST.28,0 CM	246	KRISTELLER, VAGINAL SPECULA, 115X22MM, FIG.1	262
KOCHER INT.CLAMP FCPS.STR. ELAST.28,0 CM	246	KRISTELLER, VAGINAL SPECULA, 115X24MM, FIG.2	262
KOCHER LIGATURE CONDUCTOR 15,0 CM	153	KRISTELLER, VAGINAL SPECULA, 115X26MM, FIG.2	262
KOCHER LIGATURE CONDUCTOR 15,0 CM	153	KRISTELLER, VAGINAL SPECULA, 115X32MM, FIG.3	262
KOCHER LIGATURE CONDUCTOR 16,0 CM	153	KRISTELLER, VAGINAL SPECULA, 70X27MM, FIG.1	263
KOCHER LIGATURE CONDUCTOR 18,0 CM	153	KRISTELLER, VAGINAL SPECULA, 80X30MM, FIG.2	263
KOCHER LIGATURE CONDUCTOR W/O EAR 18,0CM	153	KRISTELLER, VAGINAL SPECULA, 90X36MM, FIG.3	263
KOCHER LIGATURE NEEDLE FIG.1 19,0 CM	148	KRISTELLER, VAGINAL SPECULA, FIG. 0, 70 x 15 MM	263
KOCHER LIGATURE NEEDLE FIG.2 19,0 CM	148	KRISTELLER, VAGINAL SPECULA, SET FIG.1	262
KOCHER LIGATURE NEEDLE FIG.3 19,0 CM	148	KRISTELLER, VAGINAL SPECULA, SET FIG.1	262
KOCHER RETRACTOR 22 CM 1 PRONG BLUNT	172	KRISTELLER, VAGINAL SPECULA, SET FIG.2	262
KOCHER RETRACTOR 22 CM 1 PRONG SEMI-SH.	172	KRISTELLER, VAGINAL SPECULA, SET FIG.3	262
KOCHER RETRACTOR 22 CM 2 PRONGS SEMI-SH.	172	KRISTELLER, VAGINAL SPECULA, SET FIG.3	262
KOCHER RETRACTOR 22 CM 2 PRONGS BLUNT	172	KRISTELLER, VAGINAL SPECULA, SET, FIG.0	263
KOCHER RETRACTOR 22 CM 3 PRONGS SEMI-SH.	172	KRISTELLER, VAGINAL SPECULA, SET,17,0 CM, 70 x 15 MM	265
KOCHER RETRACTOR 22 CM 3 PRONGS BLUNT	172	KROENLEIN ARTERY FORCEPS STR 13,0 CM	98
KOCHER RETRACTOR 22 CM 4 PRONGS SEMI-SH.	172	KRONECKER LIGATURE NEEDLE LEFT 15,0 CM	149
KOCHER RETRACTOR 22 CM 4 PRONGS BLUNT	172	KRONECKER LIGATURE NEEDLE RIGHT 15,0 CM	150
KOCHER RETRACTOR 22 CM 4 PRONGS SHARP	171	LAHEY GALL DUCT CLAMP 19,0 CM	114
KOCHER RETRACTOR 22 CM 6 PRONGS SEMI-SH.	172	LAHEY GALL DUCT CLAMP 23,0 CM	114
KOCHER RETRACTOR 22 CM 6 PRONGS BLUNT	172	LAMBOTTE RASPTORIES 15MM	302
KOCHER RETRACTOR 22 CM 6 PRONGS SHARP	171	LAMBOTTE RASPTORIES 20MM	302
KOCHER RETRACTOR 22 CM 8 PRONGS SEMI-SH.	172	LAMBOTTE RASPTORIES 25MM	302
KOCHER RETRACTOR 22 CM 8 PRONGS BLUNT	172	LAMBOTTE, OSTEOTOME 15 MM, 24,0 CM	306
KOCHER RETRACTOR 22 CM 8 PRONGS SHARP	171	LAMBOTTE, OSTEOTOME 20 MM, 24,0 CM	306
KOCHER RETRACTOR 40X18 MM 23,0 CM	176	LAMBOTTE, OSTEOTOME 25 MM, 24,0 CM	306
KOCHER RETRACTOR 60X20 MM 23,0 CM	176	LAMBOTTE, OSTEOTOME 30 MM, 24,0 CM	306
KOCHER RETRACTOR 60X25 MM 23,0 CM	176	LAMBOTTE, OSTEOTOME 38 MM, 24,0 CM	306
KOCHER RETRACTOR 70X25 MM 22,0 CM	179	LAMBOTTE, OSTEOTOME 44 MM, 24,0 CM	306
KOCHER RETRACTOR 75X30 MM 23,0 CM	176	LAMBOTTE, OSTEOTOME 50 MM, 24,0 CM	306
KOCHER RETRACTOR 75X40 MM 23,0 CM	176	LAMBOTTE, OSTEOTOME CURVED, 15 MM, 24,0 CM	306
KOCHER RETRACTOR 80X42 MM 25,0 CM	179	LAMBOTTE, OSTEOTOME CURVED, 20 MM, 24,0 CM	306
KOCHER RETRACTOR 80X50 MM 25,0 CM	179	LAMBOTTE, OSTEOTOME CURVED, 25 MM, 24,0 CM	306
KOCHER RETRACTOR 80X60 MM 25,0 CM	179	LAMBOTTE, OSTEOTOME CURVED, 30 MM, 24,0 CM	306
KOCHER RETRACTOR SHARP 1 PRONG 22,0 CM	171	LAMBOTTE, OSTEOTOME CURVED, 38 MM, 24,0 CM	306
KOCHER RETRACTOR SHARP 2 PRONGS 22,0 CM	171	LAMBOTTE, OSTEOTOME CURVED, 44 MM, 24,0 CM	306
KOCHER RETRACTOR SHARP 3 PRONGS 22,0 CM	171	LAMBOTTE, OSTEOTOME CURVED, 50 MM, 24,0 CM	306
KOCHER-DELICATE ART.FCPS.CVD 1X2T 13 CM	105	LAMBOTTE, OSTEOTOME, 6 MM, 24,0 CM	306
KOCHER-DELICATE ART.FCPS.CVD 1X2T 14 CM	105	LAMBOTTE, OSTEOTOME, CURVED, 6 MM, 24,0 CM	306
KOCHER-DELICATE ART.FCPS.CVD 1X2T 16 CM	105	LAMBOTTE, RASPTORY 10 MM, 21,0 CM	302
KOCHER-DELICATE ART.FCPS.STR 1X2T 13 CM	105	LANDAU TROCAR 2,0 MM	219
KOCHER-DELICATE ART.FCPS.STR 1X2T 14 CM	105	LANDAU, TROCAR, W. IRRIGATION TUBE, Ø 2,0 MM	219
KOCHER-DELICATE ART.FCPS.STR 1X2T 16 CM	105	LANDAU, VAGINAL SPECULA, BAYONET SHAPED, 100X28 MM	267
KOCHER-LANGENBECK RETRACTOR	175	LANDAU, VAGINAL SPECULA, BAYONET SHAPED, 100X38 MM	267
KOCHER-LANGENBECK RETRACTOR 25X6 MM 21,5 CM	175	LANDOLT FINE SCISSORS MORE CVD 12,5 CM	31
KOCHER-LANGENBECK RETRACTOR 35X11MM 21,5 CM	175	LANDOLT FINE SCISSORS STRAIGHT 12,5 CM	31
KOCHER-LANGENBECK RETRACTOR 35X11MM 21,5 CM	175	LANDOLT FINE SCISSORS STRONG CVD 12,5 CM	31
KOCHER-LANGENBECK RETRACTOR 35X8 MM 21,5 CM	175	LANE STOMACH CLAMP FCPS. CURVED 30,0 CM	250
KOCHER-LANGENBECK RETRACTOR 40X11MM 21,5 CM	175	LANE STOMACH CLAMP FCPS. STR. 30,0 CM	250
KOCHER-LANGENBECK RETRACTOR 70X14MM 21,5 CM	175	LANE TISSUE FORCEPS 1X2 TEETH 14,5 CM	76
KOCHER-LANGENBECK RETRACTOR 80X12MM 21,5 CM	175	LANE TISSUE FORCEPS 1X2 TEETH 20,0 CM	76
KOCHER-LANGENBECK, RETRACTOR, 22X6 MM, 21,5 CM	175	LANE TISSUE FORCEPS 2X3 TEETH 14,5 CM	76
KOCHER-LANGENBECK, RETRACTOR, 25X8 MM, 21,5 CM	175	LANE TISSUE FORCEPS 2X3 TEETH 20,0 CM	76
KOERTE RETRACTOR 26X40 MM 24,0 CM	173	LANE TOWEL FORCEPS 15,0 CM	87
KOERTE RETRACTOR 26X40 MM 24,0 CM	173	LANE TOWEL FORCEPS 18,0 CM	87
KOGAN ENDOSPECULA 3MM, 24CM	269	LANE TOWEL FORCEPS 20,0 CM	87
KOGAN ENDOSPECULA 4MM, 24CM	269	LANE, INTESTINAL AND TISSUE GRASPING FORCEPS, 12,5 CM	242
KOGAN ENDOSPECULA 5MM, 24CM	269	LANE, INTESTINAL AND TISSUE GRASPING FORCEPS, 15,0 CM	242
KOGAN ENDOSPECULUM, 3 MM, W.RATCHET 24,0 CM	269	LANE, INTESTINAL AND TISSUE GRASPING FORCEPS, 19,5 CM	242
KOGAN ENDOSPECULUM, 4 MM, W.RATCHET 24,0 CM	269	LANGE SUTURE FORCEPS 10,0 CM	155
KOGAN ENDOSPECULUM, 5 MM, W.RATCHET 24,0 CM	269	LANGENBECK PERIOSTELEVATOR 10 MM 20,0CM	301
KÖNIG LIGATURE CONDUCTOR 3 MM 19,5 CM	152	LANGENBECK PERIOSTELEVATOR 8 MM 20,0 CM	301
KÖNIG LIGATURE CONDUCTOR 5 MM 19,5 CM	152	LANGENBECK PERIOSTEAL RASP.CVD. 19,0 CM	303
KÖNIG LIGATURE CONDUCTOR 7 MM 19,5 CM	152	LANGENBECK RETR. 21,0 CM 30X11 MM GRID	174
KÖNIG, RASPTORY, 15,5 CM	302	LANGENBECK RETR. 21,0 CM 30X14 MM GRID	174
KRAUSE TROCER 15,0 CM 3,0 MM	221	LANGENBECK RETR. 21,0 CM 30X16 MM GRID	174
KRAUSE TROCER 15,0 CM 4 MM	221	LANGENBECK RETR. 21,0 CM 40X11 MM GRID	174
KRAUSE TROCER 15,0 CM 5,0 MM	221	LANGENBECK RETR. 21,0 CM 50X11 MM GRID	174
KRAUSE TROCER 15,0 CM 5,5 MM	221	LANGENBECK RETRACTOR 22,0 CM 30X11 MM	174
KRISTELLER VAGINAL SPECULA SET FIG.0	263	LANGENBECK RETRACTOR 22,0 CM 30X14 MM	174
KRISTELLER VAGINAL SPECULA SET FIG.00	263	LANGENBECK RETRACTOR 22,0 CM 30X16 MM	174
KRISTELLER VAGINAL SPECULA SET FIG.1	263	LANGENBECK RETRACTOR 22,0 CM 40X11 MM	174
KRISTELLER VAGINAL SPECULA SET FIG.2	263	LANGENBECK RETRACTOR 22,0 CM 50X11 MM	174
KRISTELLER VAGINAL SPECULA SET FIG.3	263	LANGENBECK RETRACTOR 55X20 MM 21,0 CM	173
KRISTELLER, VAGINAL RETRACTOR, FIG. 0, 75 x 10 MM	263	LANGENBECK RETRACTOR 60X20 MM 21,0 CM	173
KRISTELLER, VAGINAL RETRACTOR, FIG. 1, 75 x 23 MM	263	LANGENBECK RETRACTOR 63X20 MM 21,0 CM	173
KRISTELLER, VAGINAL RETRACTOR, FIG. 2, 85 x 26 MM	263	LANGENBECK, AMPUTATING KNIFE, BLADE LENGTH 5,5 CM, 18,0 CM	10
KRISTELLER, VAGINAL RETRACTOR, FIG. 3, 100 X 32MM	263	LANGENBECK, NEEDLE HOLDER WITH TC 18,0 CM	143

LANGENBECK, NEEDLE HOLDER WITH TC 20.0 CM	143	MAGILL, SUCTION TUBE W. FINGERRING, Ø 3,0 MM	223
LANGENBECK, NEEDLE HOLDER WITH TC 23.0 CM	143	MAGILL, SUCTION TUBE W. FINGERRING, Ø 4,0 MM	223
LANGENBECK-GREEN, RETRACTOR, 16x6 MM, 16,0 CM HANDLE NOT AS ILLUSTRATED IN OUR CAT	161	MAINGOT, HYSTERECTOMY FORCEPS, 1X2 TEETH, 20,0 CM	120
LANGENBECK-GREEN, RETRACTOR, 24x6 MM, 16,0 CM	161	MAINGOT, HYSTERECTOMY FORCEPS, 1X2 TEETH, 25,0 CM	120
LATERAL VAGINAL RETRACTOR 25,0 CM	269	MARTEL FLAP FORCEPS 14,0 CM	97
LAWRENCE ARTERY FORCEPS CVD 28.0 CM	114	MARTIN PELVIMETERS, CM/INCH-SCALE, 34.0 CM	292
LAWRENCE, NEEDLE HOLDER, SMOOTH, 15,0 CM	126	MARTIN UTERINE PROBES, 30.0 CM	277
LEGUEU BLADDER RETRACTOR 35MM 27.0 CM	239	MARTIN, UTERINE PROBE, MALLEABLE, 32,0 CM	277
LEGUEU, BLADDER RETRACTOR	237	MARTINI, BONE CURETTE, FIG.0/1, 14,0 CM	300
LEMPERT, BONE CURETTE FIG.0, 21.5 CM	299	MARTINI, BONE CURETTE, FIG.00/0, 14,0 CM	300
LEMPERT, BONE CURETTE FIG.00, 21.5 CM	299	MARTINI, BONE CURETTE, FIG.1/2, 14,0 CM	300
LEMPERT, BONE CURETTE FIG.000, 21.5 CM	299	MASSON NEEDLE HOLDER 27.0 CM	127
LEMPERT, BONE CURETTE FIG.0000, 21.5 CM	299	MASSON NEEDLE HOLDER TC 27.0 CM	138
LERICHE ARTERY FCPS CVD 1X2 T 15.0 CM	102	MATHIEU NEEDLE HOLDER 14.0 CM	129
LERICHE ARTERY FCPS STR 1X2 T 15.0 CM	102	MATHIEU NEEDLE HOLDER 17.0 CM	129
LERICHE ARTERY FORCEPS STR 15.0 CM	102	MATHIEU NEEDLE HOLDER 20.0 CM	129
LERICHE FORCEPS CVD 15.0 CM	102	MATHIEU NEEDLE HOLDER SAFETY RAT. 17.0 CM	129
LERMOYEZ, TROCARS, Ø 2,0 MM	220	MATHIEU NEEDLE HOLDER SAFETY RAT. 20.0 CM	129
LERMOYEZ, TROCARS, Ø 2,5 MM	220	MATHIEU NEEDLE HOLDER TC 14.0 CM	141
LERMOYEZ, TROCARS, Ø 3,0 MM	220	MATHIEU NEEDLE HOLDER TC 17.0 CM	141
LEXER SCISSORS TC CURVED 16.0 CM	47	MATHIEU NEEDLE HOLDER TC 20.0 CM	141
LEXER SCISSORS TC CURVED 21.0 CM	47	MATHIEU RECTAL SPECULA 19,5 CM 90X15 MM	252
LEXER SCISSORS TC STRAIGHT 16.0 CM	47	MATHIEU RETRACTOR SET FIG.1+2	168
LEXER SCISSORS TC STRAIGHT 21.0 CM	47	MATHIEU, FOREIGN BODY FORCEPS SERRATED, 28,0 CM	238
LEXER, DISSEC.-SCS, CURVED, 16,0 CM	25	MATHIEU, FOREIGN BODY FORCEPS SERRATED, 20,0 CM	238
LEXER, DISSEC.-SCS, CURVED, 21,0 CM	25	MATHIEU, NEEDLE HOLDER 14.0 CM	129
LEXER, DISSEC.-SCS, STRAIGHT, 16,0 CM	25	MATHIEU, NEEDLE HOLDER 17.0 CM	129
LEXER, DISSEC.-SCS, STRAIGHT, 21,0 CM	25	MATHIEU, NEEDLE HOLDER WITH TC, 17,0 CM	142
LEXER-BABY, DISSECTING SCISSORS CURVED, 10,0 CM	25	MATHIEU, NEEDLE HOLDER WITH TC, 20,0 CM	142
LEXER-BABY, DISSECTING SCISSORS, STRAIGHT, 10,0 CM	25	MATHIEU, NEEDLE HOLDER WITH TC, 23,0 CM	142
LICHTENBERG, NEEDLE HOLDER WITH TC, 17,0 CM	142	MATHIEU, VAGINAL RETRACTOR, FIG. 1, 100 x 11-21 MM	267
LICHTENBERG, NEEDLE HOLDER WITH TC, 20,0 CM	142	MATHIEU, VAGINAL RETRACTOR, FIG. 2, 100 x 14-27 MM	267
LICHTWITZ TROCAR 11.0 CM 1.6MM	221	MATHIEU, VAGINAL SPECULA, FIG. 1, 100 x 13-23 MM	267
LICHTWITZ TROCAR STRAIGHT 1.8 MM	221	MATHIEU, VAGINAL SPECULA, FIG. 2, 100 x 16-30 MM	267
LIGATURE NEEDLE FLEXIBLE 20.0 CM	147	MATHIEU-KOCHER, NEEDLE HOLDER WITH TC, 14,0 CM	141
LINCOLN VASCULAR SCISSORS CVD 17.0 CM	35	MATHIEU-KOCHER, NEEDLE HOLDER WITH TC, 17,0 CM	141
LINCOLN VASCULAR SCISSORS STR 17.0 CM	35	MATHIEU-KOCHER, NEEDLE HOLDER WITH TC, 17,0 CM	141
LISTER BANDAGE SCISSORS 1 L.RING 18.5 CM	44	MATHIEU-KOCHER, NEEDLE HOLDER, 14,0 CM	130
LISTER BANDAGE SCISSORS 1 L.RING 21.0 CM	44	MATHIEU-KOCHER, NEEDLE HOLDER, 17,0 CM	130
LISTER BANDAGE SCISSORS ANGLED 11.0 CM	44	MATHIEU-KOCHER, NEEDLE HOLDER, 20,0 CM	130
LISTER BANDAGE SCISSORS ANGLED 14.0 CM	44	MATZENAUER, VAGINAL SPECULA, 100X10 MM	268
LISTER BANDAGE SCISSORS ANGLED 18.0 CM	44	MATZENAUER, VAGINAL SPECULA, 100X20 MM	268
LISTER BANDAGE SCISSORS ANGLED 20.0 CM	44	MATZENAUER, VAGINAL SPECULA, 100X25 MM	268
LISTER BANDAGE SCISSORS ANGLED 9.0 CM	44	MATZENAUER, VAGINAL SPECULA, 125X15 MM	268
LISTER BANDAGE SCISSORS TC 18.0 CM	55	MATZENAUER, VAGINAL SPECULA, 125X20 MM	268
LISTER SINUS FORCEPS 13.0 CM	88	MATZENAUER, VAGINAL SPECULA, 125X25 MM	268
LISTER SINUS FORCEPS 16.0 CM	88	MATZENAUER, VAGINAL SPECULA, 125X30 MM	268
LISTER SINUS FORCEPS 18.0 CM	88	MATZENAUER, VAGINAL SPECULA, 125X35 MM	268
LISTER-EXCENTRIC SCS.SAW EDGE 16.0 CM	44	MATZENAUER, VAGINAL SPECULA, 125X40 MM	268
LISTER-EXCENTRIC SCS.SAW EDGE 19.0 CM	44	MATZENAUER, VAGINAL SPECULA, 90X20 MM	268
LISTON, AMPUTATING KNIFE, BLADE LENGTH 22,0 CM	8	MAYO DISS.SCS TC CVD BL/BL 14.5 CM	47
LISTON, AMPUTATING KNIFE, BLADE LENGTH, 17,0 CM	8	MAYO DISS.SCS TC CVD BL/BL 17.0 CM	47
LISTON, AMPUTATING KNIFE, BLADE LENGTH, 20,0 CM	8	MAYO DISS.SCS TC CVD BL/BL 23.0 CM	47
LITTAUER, LIGATURE SCISSORS 11.5 CM	33	MAYO DISS.SCS TC STR BL/BL 14.5 CM	47
LITTAUER, LIGATURE SCISSORS 14.0 CM	33	MAYO DISS.SCS TC STR BL/BL 17.0 CM	47
LITTLE RETRACTOR 12X14 MM 20.0 CM	180	MAYO DISS.SCS TC STR BL/BL 23.0 CM	47
LLOYD-DAVIES, LOBECTOMY SCS., CURVED, BL/BL, 27.0 CM	41	MAYO OPER.SCS.CVD.BL/BL 17,0 CM SC	56
LOCKHART-MUMMERY PROBE FIG.1	215	MAYO OPER.SCS.STR.BL/BL 17.0 CM SC	56
LOCKHART-MUMMERY PROBE FIG.2	215	MAYO SAFETY PIN 14,0 CM	308
LOCKHART-MUMMERY PROBE FIG.3	215	MAYO UTERINE SCISSORS STR BL/BL 28.0 CM	18
LOCKHART-MUMMERY PROBE FIG.4	215	MAYO, GALL DUCT PROBE, 32,0 CM	235
LOCKWOOD-ALLIS, INTESTINAL. TISSUE GRASPING FORCEPS, 16,0 CM	242	MAYO, GALL STONE SCOOPS, DOUBLE-ENDED, 27,0 CM	234
LOCKWOOD-ALLIS, INTESTINAL. TISSUE GRASPING FORCEPS, 20,0 CM	242	MAYO, GALL STONE SCOOPS, MALLEABLE, FIG. 1, 27,0 CM	234
LONG CLAMP FORCEPS CVD 1X2 T. 19.0 CM	121	MAYO, GALL STONE SCOOPS, MALLEABLE, FIG. 2, 27,0 CM	234
LORENZ BANDAGE SCISSORS CVD 23.0 CM	45	MAYO, OPER.SCS., CURVED, BL/BL, 14.5 CM	18
LORNA TOWEL FORCEPS 10,0 CM	87	MAYO, OPER.SCS., CURVED, BL/BL, 17,0 CM	18
LORNA TOWEL FORCEPS 13,0 CM	87	MAYO, OPER.SCS., STRAIGHT, BL/BL, 14.5 CM	18
LOVELACE LUNG GRASPING FCPS ST	117	MAYO, OPER.SCS., STRAIGHT, BL/BL, 17,0 CM	18
LOVELACE LUNG GRASPING FORCEPS	117	MAYO, OPER.SCS., STRAIGHT, BL/BL, 23,0 CM	18
LOWER ARTERY FCPS CVD 18.0 CM	114	MAYO, UTERINE SCISSORS, CVD., BL/BL 23.0 CM	18
LUER-KOERTE, GALL STONE SCOOP ELASTIC, FIG. 00, 3,4 MM, 32,0 CM	234	MAYO, UTERINE SCISSORS, CVD., BL/BL 28.0 CM	18
LUER-KOERTE, GALL STONE SCOOP ELASTIC, FIG. 1, 5,5 MM, 32,0 CM	234	MAYO-ADAMS, APPENDECTOMY RETRACTOR 2 X 2 PRONGS, BLUNT, 17,0 CM	190
LUER-KOERTE, GALL STONE SCOOP ELASTIC, FIG. 3, 8,0 MM, 32,0 CM	234	MAYO-ADAMS, APPENDECTOMY RETRACTOR W. CENTRAL VALVE 42X14 MM, 17,0 CM	198
LUER-KOERTE, GALL STONE SCOOP ELASTIC, FIG. 5, 15,0 MM, 32,0 CM	234	MAYO-BLAKE GALL STONE FCPS 20	232
LUER-KOERTE, GALL STONE SCOOP, ELASTIC, FIG. 0, 4,3 MM, 32,0 CM	234	MAYO-BLAKE GALL STONE FCPS 20	232
LUER-KOERTE, GALL STONE SCOOP, ELASTIC, FIG. 2, 6,7 MM, 32,0 CM	234	MAYO-HEGAR NEEDLE HOLDER 14.0 CM	126
LUER-KOERTE, GALL STONE SCOOP ELASTIC, FIG. 4, 11,0 MM, 32,0 CM	234	MAYO-HEGAR NEEDLE HOLDER 16.0 CM	126
LUER-KOERTE, GALLSTONE SCOOP ELASTIC, FIG. 000, 2,8 MM, 32,0 CM	234	MAYO-HEGAR NEEDLE HOLDER 18.0 CM	126
LUER-LOCK, SPECIAL NEEDLE, 0,45 x 20 MM	224	MAYO-HEGAR NEEDLE HOLDER 20.0 CM	126
LUER-LOCK, SPECIAL NEEDLE, 0,50 x 23 MM	224	MAYO-HEGAR NEEDLE HOLDER 24.0 CM	126
LUER-LOCK, SPECIAL NEEDLE, 0,60 x 25 MM	224	MAYO-HEGAR NEEDLE HOLDER 26.0 CM	126
LUER-LOCK, SPECIAL NEEDLE, 0,65 x 28 MM	224	MAYO-HEGAR NEEDLE HOLDER 30.0 CM	126
LUER-LOCK, SPECIAL NEEDLE, 0,70 x 32 MM	224	MAYO-HEGAR NEEDLE HOLDER TC 16.0 CM	135
LUER-LOCK, SPECIAL NEEDLE, 0,80 x 32 MM	224	MAYO-HEGAR NEEDLE HOLDER TC 18.0 CM	135
LUER-LOCK, SPECIAL NEEDLE, 0,90 x 38 MM	224	MAYO-HEGAR NEEDLE HOLDER TC 20.0 CM	135
M.G.H. NEEDLE HOLDER 17.0 CM	125	MAYO-HEGAR NEEDLE HOLDER TC 24.0 CM	135
MAGILL, SUCTION TUBE W. FINGERRING, Ø 1,0 MM	223	MAYO-HEGAR NEEDLE HOLDER TC 26.0 CM	135
MAGILL, SUCTION TUBE W. FINGERRING, Ø 2,0 MM	223	MAYO-HEGAR NEEDLE HOLDER TC 30.0 CM	135
		MAYO-HEGAR, NEEDLE HOLDER WITH TC, 20,0 CM	135

MAYO-HEGAR, NEEDLE HOLDER WITH TC, 24,0 CM	135	METZENBAUM SCS TC CVD BL/BL 18.0 CM	48
MAYO-HEGAR, NEEDLE HOLDER WITH TC, 26,0 CM	135	METZENBAUM SCS TC CVD BL/BL 20.0 CM	48
MAYO-HEGAR-DELICATE NEEDLEH.16.0 CM	126	METZENBAUM SCS TC CVD BL/BL 23.0 CM	48
MAYO-HEGAR-DELICATE NEEDLEH.18.0 CM	126	METZENBAUM SCS TC CVD BL/BL 25.0 CM	48
MAYO-HEGAR-DELICATE NEEDLEH.20.0 CM	126	METZENBAUM SCS TC CVD BL/BL 28.0 CM	48
MAYO-NOBLE OPER.SCS CVD BL/BL 17.0 CM	19	METZENBAUM SCS TC CVD BL/BL 30.0 CM	48
MAYO-NOBLE OPER.SCS STR BL/BL 17.0 CM	19	METZENBAUM SCS TC CVD SH/BL 14.5 CM	48
MAYO-ROBSON INTEST.CLAMP FCPS STR.23,0CM	247	METZENBAUM SCS TC CVD SH/BL 18.0 CM	49
MAYO-ROBSON INTEST.CLAMP FCPS CVD 21.0CM	247	METZENBAUM SCS TC CVD SH/BL 20.0 CM	49
MAYO-ROBSON INTEST.CLAMP FCPS CVD 23.0CM	247	METZENBAUM SCS TC CVD SH/BL 23.0 CM	49
MAYO-ROBSON INTEST.CLAMP FCPS CVD 25.0CM	247	METZENBAUM SCS TC CVD SH/BL 25.0 CM	49
MAYO-ROBSON INTEST.CLAMP FCPS STR 21.0CM	247	METZENBAUM SCS TC CVD SH/BL 28.0 CM	49
MAYO-ROBSON INTEST.CLAMP FCPS STR 25.0CM	247	METZENBAUM SCS TC CVD SH/BL 30.0 CM	49
MAYO-ROBSON, INTESTINAL CLAMP FORCEPS, CURVED, WITH NON- TRAUMATIC SERRATION, 21,0 CM	248	METZENBAUM SCS TC CVD SH/SH 14.5 CM	48
MAYO-ROBSON, INTESTINAL CLAMP FORCEPS, CURVED, WITH NON- TRAUMATIC SERRATION, 23,0 CM	248	METZENBAUM SCS TC CVD SH/SH 18.0 CM	49
MAYO-ROBSON, INTESTINAL CLAMP FORCEPS, CURVED, WITH NON- TRAUMATIC SERRATION, 25,0 CM	248	METZENBAUM SCS TC CVD SH/SH 20.0 CM	49
MAYO-ROBSON, INTESTINAL CLAMP FORCEPS, STRAIGHT, WITH NON- TRAUMATIC SERRATION, 21,0 CM	248	METZENBAUM SCS TC CVD SH/SH 23.0 CM	49
MAYO-ROBSON, INTESTINAL CLAMP FORCEPS, STRAIGHT, WITH NON- TRAUMATIC SERRATION, 23,0 CM	248	METZENBAUM SCS TC CVD SH/SH 25.0 CM	49
MAYO-ROBSON, INTESTINAL CLAMP FORCEPS, STRAIGHT, WITH NON- TRAUMATIC SERRATION, 25,0 CM	248	METZENBAUM SCS TC CVD SH/SH 30.0 CM	49
MAYO-STILLE OPER.SCS CVD BL/BL 15.0 CM	19	METZENBAUM SCS TC STR BL/BL 14.5 CM	48
MAYO-STILLE OPER.SCS CVD BL/BL 17.0 CM	19	METZENBAUM SCS TC STR BL/BL 18.0 CM	48
MAYO-STILLE OPER.SCS CVD BL/BL 19.5 CM	19	METZENBAUM SCS TC STR BL/BL 20.0 CM	48
MAYO-STILLE OPER.SCS CVD BL/BL 21.0 CM	19	METZENBAUM SCS TC STR BL/BL 23.0 CM	48
MAYO-STILLE OPER.SCS STR BL/BL 15.0 CM	19	METZENBAUM SCS TC STR BL/BL 25.0 CM	48
MAYO-STILLE OPER.SCS STR BL/BL 19.5 CM	19	METZENBAUM SCS TC STR BL/BL 28.0 CM	48
MAYO-STILLE OPER.SCS STR BL/BL 21.0 CM	19	METZENBAUM SCS TC STR BL/BL 30.0 CM	48
MAYO-STILLE SCS TC STR BL/BL 15.0 CM	47	METZENBAUM SCS TC STR SH/BL 18.0 CM	49
MAYO-STILLE SCS TC STR BL/BL 17.0 CM	47	METZENBAUM SCS TC STR SH/BL 20.0 CM	49
MAYO-STILLE, OPERATING SCISSOR, BLUNT, STRAIGHT, 17.0 CM	19	METZENBAUM SCS TC STR SH/BL 23.0 CM	49
MC GIVNEY, HAEMORROIDAL GRASPING FORCEPS, 19,0 CM	256	METZENBAUM SCS TC STR SH/SH 25.0 CM	49
MC GIVNEY, HAEMORROIDAL GRASPING FORCEPS, 19,0 CM	256	METZENBAUM SCS TC STR SH/SH 28.0 CM	49
MC GIVNEY, HAEMORROIDAL W. LOADING ATTACHMENT	255	METZENBAUM SCS TC STR SH/SH 30.0 CM	49
MC INDOE CARTILAGE SCISSORS 19,0 CM	39	METZENBAUM SCS TC STRAIGHT SH/BL 14.5 CM	48
MC INDOE DRESSING FORCEPS 15,0 CM	66	METZENBAUM SCS TC STRAIGHT SH/SH 14.5 CM	48
MC INDOE, DRESSING FCPS, TC, 15.0 CM	83	METZENBAUM, NEEDLE HOLDER, 18,0 CM	125
MC INDOE, TISSUE FCPS, 1X2 TEETH, SERRATED, 15.0 CM	73	METZENBAUM-BABY CVD BL/BL 11.5 CM	20
MC LEAN, OBSTETRICAL FORCEPS, 36.0 CM	290	METZENBAUM-BABY STR BL/BL 11.5 CM	20
MC QUIGG-MIXTER, DISSECTINGAND LIGATURE FORCEPS, 22,0 CM	115	METZENBAUM-DELICATE BL/BL CVD 14.5 CM	22
MCDONALD ELEVATOR 19,0CM	301	METZENBAUM-DELICATE BL/BL CVD 18.0 CM	23
MEDICINE CUP 50 CCM	310	METZENBAUM-DELICATE BL/BL CVD 23.0 CM	23
MEEKER ARTERY FORCEPS CVD 18.0 CM	113	METZENBAUM-DELICATE BL/BL CVD 25.0 CM	23
MEEKER ARTERY FORCEPS CVD 28.0 CM	113	METZENBAUM-DELICATE BL/BL CVD 28.0 CM	23
MENGHINI, LIVER BLIND PUNCTURE NEEDLE, Ø1,0 X 35MM	226	METZENBAUM-DELICATE BL/BL CVD 30.0 CM	23
MENGHINI, LIVER BLIND PUNCTURE NEEDLE, Ø1,2 X 100MM	226	METZENBAUM-DELICATE BL/BL STR 14.5 CM	22
MENGHINI, LIVER BLIND PUNCTURE NEEDLE, Ø1,2 X 70MM	226	METZENBAUM-DELICATE BL/BL STR 18.0 CM	22
MENGHINI, LIVER BLIND PUNCTURE NEEDLE, Ø1,4 X 100MM	226	METZENBAUM-DELICATE BL/BL STR 20.0 CM	22
MENGHINI, LIVER BLIND PUNCTURE NEEDLE, Ø1,6 X 70MM	226	METZENBAUM-DELICATE BL/BL STR 23.0 CM	22
MENGHINI, LIVER BLIND PUNCTURE NEEDLE, Ø1,8 X 100MM	226	METZENBAUM-DELICATE BL/BL STR 25.0 CM	22
MENGHINI, LIVER BLIND PUNCTURE NEEDLE, Ø1,8 X 168MM	226	METZENBAUM-DELICATE BL/BL STR 28.0 CM	22
MENGHINI, LIVER BLIND PUNCTURE NEEDLE, Ø1,0 X 70MM	226	METZENBAUM-DELICATE BL/BL STR 30.0 CM	22
MENGHINI, LIVER BLIND PUNCTURE NEEDLE, Ø1,4 X 168MM	226	METZENBAUM-DELICATE SH/SH CVD 18.0 CM	23
MENGHINI, LIVER BLIND PUNCTURE NEEDLE, Ø1,4 X 70MM	226	METZENBAUM-DELICATE SH/SH CVD 20.0 CM	23
METAL CATHETER FOR MEN, 10 CH, 29,0 CM	240	METZENBAUM-DELICATE SH/SH CVD 23.0 CM	23
METAL CATHETER FOR MEN, 12 CH, 29,0 CM	240	METZENBAUM-DELICATE SH/SH CVD 25.0 CM	23
METAL CATHETER FOR MEN, 14 CH, 29,0 CM	240	METZENBAUM-DELICATE SH/SH CVD 28.0 CM	23
METAL CATHETER FOR MEN, 16 CH, 29,0 CM	240	METZENBAUM-DELICATE SH/SH CVD 30.0 CM	23
METAL CATHETER FOR MEN, 18 CH, 29,0 CM	240	METZENBAUM-DELICATE SH/SH STR 18.0 CM	23
METAL CATHETER FOR MEN, 20 CH, 29,0 CM	240	METZENBAUM-DELICATE SH/SH STR 20.0 CM	23
METAL CATHETER FOR MEN, 22 CH, 29,0 CM	240	METZENBAUM-DELICATE SH/SH STR 23.0 CM	23
METAL CATHETER FOR MEN, 24 CH, 29,0 CM	240	METZENBAUM-DELICATE SH/SH STR 25.0 CM	23
METAL CATHETER FOR MEN, 8 CH, 29,0 CM	240	METZENBAUM-DELICATE SH/SH STR 28.0 CM	23
METAL CATHETER FOR WOMEN, 10 CH, 16,0 CM	240	METZENBAUM-DELICATE SH/SH STR 30.0 CM	23
METAL CATHETER FOR WOMEN, 11 CH, 16,0 CM	240	METZENBAUM-FINO S, DISSEC. SCS., S-SHAPED, BL/BL, 18.0 CM	24
METAL CATHETER FOR WOMEN, 12 CH, 16,0 CM	240	METZENBAUM-FINO S, DISSEC. SCS., S-SHAPED, BL/BL, 20.0 CM	24
METAL CATHETER FOR WOMEN, 13 CH, 16,0 CM	240	METZENBAUM-FINO S, DISSEC. SCS., S-SHAPED, BL/BL, 23.0 CM	24
METAL CATHETER FOR WOMEN, 14 CH, 16,0 CM	240	METZENBAUM-FINO S, DISSEC. SCS., S-SHAPED, SH/SH, 18.0 CM	24
METAL CATHETER FOR WOMEN, 15 CH, 16,0 CM	240	METZENBAUM-FINO S, DISSEC. SCS., S-SHAPED, SH/SH, 20.0 CM	24
METAL CATHETER FOR WOMEN, 16 CH, 16,0 CM	240	METZENBAUM-FINO S, DISSEC. SCS., S-SHAPED, SH/SH, 23.0 CM	24
METAL CATHETER FOR WOMEN, 18 CH, 16,0 CM	240	METZENBAUM-FINO S, DISSEC.-SCS. TC, S-SHAPED, BL/BL, 18.0 CM ILLUSTR. IN CAT.	51
METAL CATHETER FOR WOMEN, 20 CH, 16,0 CM	240	METZENBAUM-FINO S, DISSEC.-SCS. TC, S-SHAPED, BL/BL, 18.0 CM ILLUSTR. IN CAT.	51
METAL CATHETER FOR WOMEN, 24 CH, 16,0 CM	240	METZENBAUM-FINO S, DISSEC.-SCS. TC, S-SHAPED, BL/BL, 20.0 CM ILLUSTR. IN CAT.	51
METAL CATHETER FOR WOMEN, 6 CH, 16,0 CM	240	METZENBAUM-FINO S, DISSEC.-SCS. TC, S-SHAPED, BL/BL, 23.0 CM ILLUSTR. IN CAT.	51
METAL CATHETER FOR WOMEN, 7 CH, 16,0 CM	240	METZENBAUM-FINO S, DISSEC.-SCS. TC, S-SHAPED, BL/BL, 20.0 CM ILLUSTR. IN CAT.	51
METAL CATHETER FOR WOMEN, 8 CH, 16,0 CM	240	METZENBAUM-FINO S, DISSEC.-SCS. TC, S-SHAPED, BL/BL, 23.0 CM ILLUSTR. IN CAT.	51
METAL CATHETER FOR WOMEN, 9 CH, 16,0 CM	240	METZENBAUM-FINO SCS TC CVD BL18,0CM	50
METZENBAUM DELICATE BL/BL CVD 20.0 CM	23	METZENBAUM-FINO SCS TC CVD BL20,0CM	50
METZENBAUM SCISS TC CVD BL/BL 11.5 CM	48	METZENBAUM-FINO SCS TC CVD BL23,0CM	50
METZENBAUM SCISS TC STR BL/BL 11.5 CM	48		
METZENBAUM SCISSOR CVD.BL/BL 14,0 CM SC	56		
METZENBAUM SCISSORS CVD BL/BL 14.5 CM	20		
METZENBAUM SCISSORS CVD SH/BL 14.5 CM	20		
METZENBAUM SCISSORS CVD SH/SH 14.5 CM	20		
METZENBAUM SCISSORS STR BL/BL 14.5 CM	20		
METZENBAUM SCS TC CVD BL/BL 14.5 CM	48		

METZENBAUM-FINO SCS TC CVD BL25,0CM	50	MICRO RYDER NEEDLE HOLDER TC 13,0 CM	136
METZENBAUM-FINO SCS TC CVD BL28,0CM	50	MICRO RYDER NEEDLE HOLDER TC 15,0 CM	136
METZENBAUM-FINO SCS TC CVD BL30,0CM	50	MICRO RYDER NEEDLE HOLDER TC 18,0 CM	136
METZENBAUM-FINO SCS TC CVD SH20,0CM	50	MICRO RYDER NEEDLE HOLDER TC 20,0 CM	136
METZENBAUM-FINO SCS TC CVDSH 18,0CM	50	MICRO RYDER NEEDLE HOLDER TC 23,0 CM	136
METZENBAUM-FINO SCS TC CVDSH 23,0CM	50	MICRO RYDER NEEDLE HOLDER TC 26,0 CM	136
METZENBAUM-FINO SCS TC CVDSH 25,0CM	50	MICRO SCISSORS 18,0 CM, 125°	60
METZENBAUM-FINO SCS TC CVDSH 28,0CM	50	MICRO SCISSORS 18,0 CM, 125° ANGLED	60
METZENBAUM-FINO SCS TC CVDSH 30,0CM	50	MICRO SCISSORS 18,0 CM, 25°	60
METZENBAUM-FINO SCS TC STR BL20,0CM	50	MICRO SCISSORS 18,0 CM, 25° ANGLED	60
METZENBAUM-FINO SCS TC STR BL23,0CM	50	MICRO SCISSORS 18,0 CM, 45°	60
METZENBAUM-FINO SCS TC STR BL25,0CM	50	MICRO SCISSORS 18,0 CM, 45° ANGLED	60
METZENBAUM-FINO SCS TC STR BL28,0CM	50	MICRO SCISSORS 18,0 CM, 60°	60
METZENBAUM-FINO SCS TC STR BL30,0CM	50	MICRO SCISSORS 18,0 CM, 60° ANGLED	60
METZENBAUM-FINO SCS TC STR SH18,0CM	50	MICRO SCISSORS 18,0 CM, 90°	60
METZENBAUM-FINO SCS TC STR SH20,0CM	50	MICRO SCISSORS 18,0 CM, 90° ANGLED	60
METZENBAUM-FINO SCS TC STR SH23,0CM	50	MICRO-ADSON DRESS. FORCEPS 12,0 CM	66
METZENBAUM-FINO SCS TC STR SH25,0CM	50	MICRO-ADSON DRESS. FORCEPS 15,0 CM	66
METZENBAUM-FINO SCS TC STR SH28,0CM	50	MICRO-ADSON, DISSECTING AND LIGATURE FORCEPS, 14,0 CM	108
METZENBAUM-FINO SCS TC STR SH30,0CM	50	MICRO-ADSON, TISSUE FORCEPS 1 X 2 TEETH, Ø 0.6 MM, 12,0 CM	71
METZENBAUM-FINO SCS TC STRBL 18,0CM	50	MICRO-ADSON, TISSUE FORCEPS 1 X 2 TEETH, Ø 0.6 MM, 15,0 CM	71
METZENBAUM-FINO TC CVD BL/BL 14,5 CM	49	MICRO-FORCEPS, SELFRETAINING, SMOOTH, 10,0 CM	78
METZENBAUM-FINO TC CVD SH/SH 14,5 CM	49	MICRO-MOSQUITO ART.FCPS 1X2 CVD 12,0 CM	101
METZENBAUM-FINO TC STR BL/BL 14,5 CM	49	MICRO-MOSQUITO ART.FCPS 1X2 STR 10,0 CM	101
METZENBAUM-FINO TC STR SH/SH 14,5 CM	49	MICRO-MOSQUITO ART.FCPS 1X2 STR 12,0 CM	101
METZENBAUM-FINO, DISSEC.-SCS., SUPERCUT CURVED, BL/BL, 14,5 CM	56	MICRO-MOSQUITO ARTERY FORCEPS CVD 10,0CM	101
METZENBAUM-FINO, DISSEC.-SCS., SUPERCUT CURVED, BL/BL, 18,0 CM	56	MICRO-MOSQUITO FCPS 1X2 CVD 10,0 CM	101
METZENBAUM-FINO, DISSEC.-SCS., SUPERCUT CURVED, BL/BL, 20,0 CM	56	MICRO-MOSQUITO FORCEPS CVD 12,0CM	101
METZENBAUM-FINO, DISSEC.-SCS., SUPERCUT CURVED, BL/BL, 23,0 CM	56	MICRO-MOSQUITO FORCEPS STR 10,0CM	101
METZENBAUM-LAHEY, DISSEC. SCS. TC, CURVED, BL/BL, 14,0 CM	54	MICRO-MOSQUITO FORCEPS STR 12,0CM	101
METZENBAUM-LAHEY, DISSEC. SCS., CURVED, BL/BL, 14,0 CM	20	MICRO-NEEDLE HOLDER, CURVED, 0,4 MM JAW, 14,0 CM	132
METZENBAUM-NELSON SCISSORS CVD, 18,0 CM SUPERCUT	56	MICRO-NEEDLE HOLDER, CURVED, 18,5 CM	131
METZENBAUM-NELSON SCS CVD 20,0 CM SC	56	MICRO-NEEDLE HOLDER, CURVED, W. RATCHET, 0,4 MM JAW, 14,0 CM	132
METZENBAUM-NELSON SCS CVD BL/BL 18,0 CM	21	MICRO-NEEDLE HOLDER, ROUND HANDLE Ø 10 MM, CURVED, 0,5 MM JAW, 14,0 CM	132
METZENBAUM-NELSON SCS CVD BL/BL 20,0 CM	21	MICRO-NEEDLE HOLDER, ROUND HANDLE Ø 10 MM, W. RATCHET, CURVED, 0,5 MM JAW, 14,0 CM	132
METZENBAUM-NELSON SCS CVD BL/BL 23,0 CM	21	MICRO-NEEDLE HOLDER, ROUND HANDLE Ø 8 MM, CURVED, 0,4 MM JAW, 13,0 CM	132
METZENBAUM-NELSON SCS CVD BL/BL 25,0 CM	21	MICRO-NEEDLE HOLDER, ROUND HANDLE Ø 8 MM, W. RATCHET, CURVED, 0,4 MM JAW, 13,0 CM	132
METZENBAUM-NELSON SCS CVD BL/BL 28,0 CM	21	MICRO-NEEDLE HOLDER, STRAIGHT, 0,4 MM JAW, 14,0 CM	132
METZENBAUM-NELSON SCS CVD BL/BL 30,0 CM	21	MICRO-NEEDLE HOLDER, STRAIGHT, 18,5 CM	131
METZENBAUM-NELSON SCS CVD SH/BL 18,0 CM	21	MICRO-NEEDLE HOLDER, WITH RATCHET, CURVED, 18,5 CM	131
METZENBAUM-NELSON SCS CVD SH/BL 20,0 CM	21	MICRO-NEEDLE HOLDER, WITH RATCHET, STRAIGHT, 18,5 CM	131
METZENBAUM-NELSON SCS CVD SH/BL 23,0 CM	21	MICRO-SCS., FLAT-HANDLE, ANGLED, SH/SH, 18,5 CM	59
METZENBAUM-NELSON SCS CVD SH/BL 25,0 CM	21	MICRO-SCS., FLAT-HANDLE, CURVED, SH/SH, 18,5 CM	59
METZENBAUM-NELSON SCS CVD SH/BL 28,0 CM	21	MICRO-SCS., FLAT-HANDLE, STRAIGHT, SH/SH, 18,5 CM	59
METZENBAUM-NELSON SCS CVD SH/SH 18,0 CM	22	MIDDELDORPF RETRACTOR 14X17 MM 21,5 CM	177
METZENBAUM-NELSON SCS CVD SH/SH 20,0 CM	22	MIDDELDORPF RETRACTOR 14X7 MM 21,5 CM	177
METZENBAUM-NELSON SCS CVD SH/SH 23,0 CM	22	MIDDELDORPF RETRACTOR 20X22 MM 22,0 CM	177
METZENBAUM-NELSON SCS CVD SH/SH 25,0 CM	22	MIDDELDORPF RETRACTOR 20X22 MM 22,0 CM	177
METZENBAUM-NELSON SCS CVD SH/SH 28,0 CM	22	MIDDELDORPF RETRACTOR 26X30 MM 23,5 CM	177
METZENBAUM-NELSON SCS CVD SH/SH 30,0 CM	22	MIDDELDORPF RETRACTOR 26X30 MM 23,5 CM	177
METZENBAUM-NELSON SCS STR BL/BL 18,0 CM	21	MIDDELDORPF, RETRACTOR, 40x45 MM, 25,5 CM	178
METZENBAUM-NELSON SCS STR BL/BL 20,0 CM	21	MIDDELDORPF, RETRACTOR, 40x50 MM, 25,5 CM	178
METZENBAUM-NELSON SCS STR BL/BL 23,0 CM	21	MIDDELDORPF, RETRACTOR, 55x70 MM, 25,5 CM	178
METZENBAUM-NELSON SCS STR BL/BL 25,0 CM	21	MIKULICZ PERIT.CLAMP-FCPS 1X2 T 18,0 CM	118
METZENBAUM-NELSON SCS STR BL/BL 28,0 CM	21	MIKULICZ PERIT.CLAMP-FCPS 1X2 T. 20,0 CM	118
METZENBAUM-NELSON SCS STR SH/BL 20,0 CM	21	MIKULICZ RETRACTOR 120X50 MM 26,0 CM	181
METZENBAUM-NELSON SCS STR SH/BL 23,0 CM	21	MIKULICZ RETRACTOR 155X50 MM 26,0 CM	181
METZENBAUM-NELSON SCS STR SH/BL 25,0 CM	21	MIKULICZ RETRACTOR 85X35 MM 26,0 CM	181
METZENBAUM-NELSON SCS STR SH/BL 28,0 CM	21	MIKULICZ RETRACTOR 90X50 MM 26,0 CM	181
METZENBAUM-NELSON SCS STR SH/SH 18,0 CM	22	MILAN BIOPSY CURETTE 7MM, 28,0CM	278
METZENBAUM-NELSON SCS STR SH/SH 20,0 CM	22	MILAN BIOPSY CURETTE 9MM, 28,0CM	278
METZENBAUM-NELSON SCS STR SH/SH 23,0 CM	22	MILAN BIOPSY CURETTES 4MM, 28,0CM	278
METZENBAUM-NELSON SCS STR SH/SH 25,0 CM	22	MILKULICZ, SIGMOID ANASTOMOSIS FORCEPS, 19,0 CM	251
METZENBAUM-NELSON SCS STR SH/SH 28,0 CM	22	MILLIGAN, SELF-RETAINING RETRACTOR, 3x3 PRONGS, SHARP, 13,0 CM	192
METZENBAUM-NELSON SCS STR SH/SH 30,0 CM	22	MILLIN, BLADDER NECK SPREADER 29,5 CM	238
METZENBAUM-NELSON SCS.CVD. 23,0 CM SC	56	MILLIN, BLADDER RETRACTOR CENTRAL VALVE 120 X 45 MM	237
MEYERDING RECTRACTOR 18CM 7X4MM	162	MILLIN, BLADDER RETRACTOR LATERAL VALVES 57 X 25 MM	237
MEYERDING RECTRACTOR 18CM 7X4MM	162	MILLIN, BLADDER RETRACTOR LATERAL VALVES 80 X 25 MM	237
MEYERDING RECTRACTOR 18CM 10X3MM	162	MILLIN, BLADDER RETRACTOR, COMPLETE 2 VALVES 57 X 25 MM, 2 VALVES 80 X 25 MM	237
MEYERDING RECTRACTOR 18CM 10X4MM	162	MM 1 CENTRAL VALVE 120 X 45 MM	237
MEYERDING RECTRACTOR 18CM 16X5MM	162	MILLIN, BLADDER RETRACTOR, ONLY 21,5 CM	237
MEYERDING RECTRACTOR 18CM 18X7MM	162	MILLIN, CAPSULE FORCEPS FOR RETROPUBIC PROSTATECTOMY 24,0 CM	238
MEYERDING RECTRACTOR 50X16 MM 22,5 CM	183	MILLIN, CAPSULE FORCEPS, ATRAUMATIC, 24,0 CM	238
MEYERDING RECTRACTOR 75X25 MM 22,5 CM	183	MILLIN, LIGATURE CARRYING FORCEPS 24,0 CM	238
MEYERDING RECTRACTOR 90X50 MM 22,5 CM	183	MILLIN, PROSTATIC LOBE HOLDING FORCEPS FOR ANTERIOR LOBES, 23,0 CM	238
MICHEL CLIP FORCEPS 12,0 CM	154	MINI-GEMINI, DISSECTING AND LIGATURE FCPS., 18,0 CM	112
MICHEL CLIPS 10PACK = 1000 EA 12 X 3 MM	155	MINI-GEMINI, DISSECTING AND LIGATURE FCPS., 22,0 CM	112
MICHEL CLIPS 10PACK = 1000 EA 14 X 3 MM	155	MINI-GEMINI, DISSECTING AND LIGATURE FCPS., 25,0 CM	112
MICHEL CLIPS 10PACK =1000 EA 11 X 2 MM	155	MINI-GEMINI, DISSECTING AND LIGATURE FCPS., 28,0 CM	112
MICHEL CLIPS 10PACK =1000 EA 16 X 3 MM	155	MINI-LANGENBECK RETRACTOR 10X6 MM 16,0CM	162
MICHEL CLIPS 10PACK =1000 EA 18 X 3 MM	155	MINI-LANGENBECK RETRACTOR 17X5 MM 16,0CM	162
MICHEL CLIPS 10PACK =1000 EA 20 X 3 MM	155	MINI-LANGENBECK RETRACTOR 20X6 MM 16,0CM	162
MICHEL CLIPS 10PACK =1000 EA 22 X 3 MM	155	MINI-LANGENBECK RETRACTOR 22X8 MM 16,0CM	162
MICHEL CLIPS 10PACK =1000 EA 7,5 X 1,75	155	MINI-ROUX, RETRACTOR, 14,0 CM	168
MICHEL SUTURE FORCEPS 12,0 CM	155	MINI-TOWNSEND, CERVICAL BIOPSY AND SPECIMEN FORCEPS, 21,0 CM	288
MICHEL, SUTURE INSTRUMENTS SET, COMPLETE	155	MIXING BOWL 116 x 50 MM	309

MIXING BOWL 128 x 55 MM	309	NELATON PROBE 16.0 CM	214
MIXING BOWL 147 x 65 MM	309	NELSON TROCER FIG.1, Ø 7.5 MM 21.0 CM	220
MIXING BOWL 40 x 19 MM	309	NELSON TROCER FIG.2, Ø 9.5 MM 21.0 CM	220
MIXING BOWL 61 x 30 MM	309	NELSON TROCER FIG.3, Ø 11.0 MM 21.0 CM	220
MIXING BOWL 80 x 40 MM	309	NELSON TROCER FIG.4, Ø 12.5 MM 21.0 CM	220
MIXTER ARTERY FORCEPS FIG.1 22.0 CM	114	NELSON, GRASPING FORCEPS 15.0 CM	75
MIXTER ARTERY FORCEPS CVD 15.5 CM	113	NELSON, GRASPING FORCEPS 20.0 CM	75
MIXTER FORCEPS FIG.2 25.0 CM	114	NELSON, GRASPING FORCEPS 23.0 CM	75
MIXTER FORCEPS FIG.3 28.0 CM	114	NERVE DISSECTING SCISSORS CVD 15.0 CM	27
MIXTER GALL STONE FCPS 22CM	232	NERVE DISSECTING SCISSORS STR 15.0 CM	27
MIXTER OPERAT.AND GYN.SCISS. CVD 15.5 CM	25	NON-TRAUMATIC HAEMORRHOIDAL FORCEPS 25CM	97
MIXTER OPERAT.AND GYN.SCISS. STR 15.5 CM	25	NON-TRAUMATIC HAEMORRHOIDAL FORCEPS 27CM	97
MIXTER, DISSECTING FORCEPS, CVD, 19.0 CM	113	NORFOLK/NORWICH, SELF-RETAINING RETRACTOR, 4x5 PRONGS, BLUNT, 22.0 CM	196
MIXTER, DISSECTING FORCEPS, CVD, 22.0 CM	113	NORTHBENT LIGATURE SCISSORS CVD 12.5 CM	34
MIXTER, DISSECTING FORCEPS, CVD,23.0CM	113	NOTO POLYPUSS FORCEPS 27.5 CM	276
MIXTER-O'SHAUGNESSY ART.FCPS CVD 15.5 CM	113	NOVAK, SUCTION BIOPSY CURETTE, Ø 4.0 MM, 23.0 CM	278
MIXTER-O'SHAUGNESSY ART.FCPS CVD,19.0CM	113	OCHSNER ENT TROCER 14 CHARR.	220
MOCK, IRRIGATION CANNULA, 6.0 CM	224	OCHSNER TROCER 12 CHARR.	220
MOD.BONN SCISSORS CVD 8.0 CM	30	OCHSNER TROCER 16 CHARR.	220
MOD.BONN SCISSORS STR 8.0 CM	30	OCHSNER TROCER 20 CHARR.	220
MOD.USA TISSUE FCPS 1X2 TEETH 12.0 CM	71	OCHSNER, GALL DUCT PROBE, 35.0 CM	235
MOD.USA TISSUE FCPS 1X2 TEETH 13.0 CM	71	OCHSNER-KOCHER ART.FCPS.CVD 16.0 CM	106
MOD.USA TISSUE FCPS 1X2 TEETH 14.5 CM	71	OCHSNER-KOCHER ART.FCPS.CVD 26.0 CM	106
MOD.USA TISSUE FCPS 1X2 TEETH 15.5 CM	71	OCHSNER-KOCHER ART.FCPS.CVD 30.0 CM	106
MOD.USA TISSUE FCPS 1X2 TEETH 18.0 CM	71	OCHSNER-KOCHER ART.FCPS.STR 24.0 CM	106
MOD.USA TISSUE FCPS 1X2 TEETH 21.0 CM	71	OCHSNER-KOCHER ART.FCPS.STR 26.0 CM	106
MOD.USA TISSUE FCPS 1X2 TEETH 25.0 CM	71	OCHSNER-KOCHER ART-FCPS.STR 16.0 CM	106
MOD.USA TISSUE FCPS 1X2 TEETH 31.0 CM	71	OCHSNER-KOCHER ART-FCPS.STR 22.0 CM	106
MOD.USA TISSUE FCPS 2X3 TEETH 13.0 CM	71	OCHSNER-KOCHER ART-FCPS.STR 30.0 CM	106
MOD.USA TISSUE FCPS 2X3 TEETH 14.5 CM	71	OCHSNER-KOCHER FCPS CVD 18,0 CM	106
MOD.USA TISSUE FCPS 2X3 TEETH 15.5 CM	71	OCHSNER-KOCHER FCPS. CVD. 14.0 CM	106
MOD.USA TISSUE FORCEPS 2X3 TEETH 12.0 CM	71	OCHSNER-KOCHER FCPS. STR. 14.0 CM	106
MOD.USA TISSUE FORCEPS 2X3 TEETH 18.0 CM	71	OCHSNER-KOCHER FCPS.CVD 20.0 CM	106
MOD.USA TISSUE FORCEPS 2X3 TEETH 21.0 CM	71	OCHSNER-KOCHER FCPS CVD 22.0 CM	106
MOD.USA TISSUE FORCEPS 2X3 TEETH 25.0 CM	71	OCHSNER-KOCHER FCPS.CVD 24.0 CM	106
MOD.USA TISSUE FORCEPS 2X3 TEETH 31.0 CM	71	OCHSNER-KOCHER FCPS.STR 18.0 CM	106
MOD.USA UMBILICAL SCISSORS 10.5 CM	43	OCHSNER-KOCHER FCPS.STR 20.0 CM	106
MOD.WIEN LIGATURE CATCHER 23.5 CM	154	O'CONNOR DELICATE HOOK 16.0 CM	158
MOLLISON RETRACTOR SHARP 15.0 CM	190	OLIVE ONLY	222
MORGAN, PROCTOSCOPE, Ø 17 X 65 MM	254	OLSEN-HEGAR NEEDLE HOLDER/SCS 14.0 CM	128
MORGAN, PROCTOSCOPE, Ø 17 X 80 MM	254	OLSEN-HEGAR NEEDLE HOLDER/SCS 17.0 CM	128
MORGAN, PROCTOSCOPE, Ø 20 X 65 MM	254	OLSEN-HEGAR NEEDLE HOLDER/SCS 19.0 CM	128
MORGAN, PROCTOSCOPE, Ø 20 X 80 MM	254	OLSEN-HEGAR NEEDLE HOLDER/SCS. TC 14 CM	140
MORGAN, PROCTOSCOPE, Ø 24 X 65 MM	254	OLSEN-HEGAR NEEDLE HOLDER/SCS. TC 17 CM	140
MORGAN, PROCTOSCOPE, Ø 24 X 80 MM	254	OLSEN-HEGAR, NEEDLE HOLDER/SCS., 14.0 CM	128
MORRIS, RETRACTOR, 127x40 MM, 32,0 CM	181	OLSEN-HEGAR, NEEDLE HOLDER/SCS., WITH TC, 18,0 CM	140
MORRIS, RETRACTOR, 127x62 MM, 32,0 CM	181	OP.SCISSORS GRAZIL CVD BL/BL 13.0 CM	17
MOYNIHAN HYSTERECTOMY FORCEPS 23.0 CM	120	OP.SCISSORS GRAZIL CVD BL/BL 14.5 CM	17
MOYNIHAN, GALL STONE PROBE AND SCOOP, 34.0 CM	234	OP.SCISSORS GRAZIL CVD SH/BL 13.0 CM	17
MUSEUX, UTERINE TENACULUM FORCEPS, 2X2 TEETH, 10 MM, CURVED, 24,0 CM	275	OP.SCISSORS GRAZIL CVD SH/BL 14.5 CM	17
MUSEUX, UTERINE TENACULUM FORCEPS, 2X2 TEETH, 10 MM, CURVED, 24,0 CM	275	OP.SCISSORS GRAZIL CVD SH/SH 13.0 CM	18
MUSEUX, UTERINE TENACULUM FORCEPS, 2X2 TEETH, 6 MM, CURVED, 24,0 CM	275	OP.SCISSORS GRAZIL CVD SH/SH 14.5 CM	18
MUSEUX, UTERINE TENACULUM FORCEPS, 2X2 TEETH, 6 MM, CURVED, 24,0 CM	275	OP.SCISSORS GRAZIL STR BL/BL 13.0 CM	17
MUSEUX, UTERINE TENACULUM FORCEPS, 2X2 TEETH, 8 MM, CURVED, 24,0 CM	275	OP.SCISSORS GRAZIL STR BL/BL 14.5 CM	17
MUSEUX, UTERINE TENACULUM FORCEPS, 2X2 TEETH, 8 MM, CURVED, 24,0 CM	275	OP.SCISSORS GRAZIL STR SH/BL 13.0 CM	17
MYRTLE LEAF PROBE 11,5 CM	214	OP.SCISSORS GRAZIL STR SH/BL 14.5 CM	17
MYRTLE LEAF PROBE 13,0 CM	214	OP.SCISSORS GRAZIL STR SH/SH 14.5 CM	18
MYRTLE LEAF PROBE 14,5 CM	214	OPERATING KNIFE, FIG.10, SOLID HANDLE, 17,0 CM	6
MYRTLE LEAF PROBE, 16,0 CM	214	OPERATING KNIFE, FIG.12, SOLID HANDLE, 17,0 CM	6
MYRTLE LEAF PROBE, 18,0 CM	214	OPERATING KNIFE, FIG.14, SOLID HANDLE, 17,0 CM	6
MYRTLE LEAF PROBE, 20,0 CM	214	OPERATING KNIFE, FIG.16, SOLID HANDLE, 17,0 CM	6
NABATOFF VARICOSE VEIN PROBE SET COMPL.	217	OPERATING KNIFE, FIG.18, SOLID HANDLE, 17,0 CM	6
NABATOFF, CABLE FLEXIBLE STAINLESS	217	OPERATING SCISSORS, STANDARD STRAIGHT, BLUNT/BLUNT, 11.5 CM	14
NABATOFF, HANDLE ONLY	217	OSTEOTOME 10MM 13,5CM	304
NABATOFF, METAL-CASE ONLY.	217	OSTEOTOME 12MM 13,5CM	340
NABATOFF, OLIVE ONLY, 12,0 MM	217	OSTEOTOME 14MM 13,5CM	304
NABATOFF, OLIVE ONLY, 6,0 MM	217	OSTEOTOME 16MM 13,5CM	304
NABATOFF, OLIVE ONLY, 9,0 MM	217	OSTEOTOME, 8MM, 13,5 CM	304
NABATOFF, PROBE TIP PLASTIC MATERIAL	217	O'SULLIVAN-O'CONNOR ABDOMINAL RETRACTOR	205
NABATOFF, PROBE TIP ONLY METAL	217	O'SULLIVAN-O'CONNOR BLADE 110X70 MM	205
NAEGELE, OBSTETRICAL FORCEPS, 36,0 CM	290	O'SULLIVAN-O'CONNOR FRAME	205
NAEGELE, OBSTETRICAL FORCEPS, 40,0 CM	290	OVERHOLT ART.FCPS S-SHAPED 21.0 CM	109
NAGER LIGATURE NEEDLE 24.0 CM	150	OVERHOLT ART.FCPS S-SHAPED 21.5 CM	109
NAIL NIPPER FORCEPS, 13,0 CM	296	OVERHOLT ART.FCPS.S-SHAPED 18,5 CM	109
NAIL NIPPER FORCEPS, 13,5 CM	296	OVERHOLT ART.FCPS.S-SHAPED 20.5 CM	109
NAIL NIPPER FORCEPS, WITH LOCK, STRAIGHT BLADES, 14,0 CM	296	OVERHOLT-GEISSENDOERFER FIG.1 21.0 CM	110
NAIL NIPPER FORCEPS, WITH LOCK, CURVED BLADES, 14,0 CM	296	OVERHOLT-GEISSENDOERFER FIG.1 27.0 CM	110
NEEDLE CASE 65 MM	310	OVERHOLT-GEISSENDOERFER FIG.2 21.0 CM	110
NEEDLE CASE, INSERT ONLY, Ø 65 MM	310	OVERHOLT-GEISSENDOERFER FIG.2 27.0 CM	110
NEEDLE HOLDER, SWEDISH PATTERN, WITH TC, 15,0 CM	137	OVERHOLT-GEISSENDOERFER FIG.3 21.0 CM	110
NEEDLE HOLDER, SWEDISH PATTERN, WITH TC, 17,0 CM	137	OVERHOLT-GEISSENDOERFER FIG.3 27.0 CM	110
NEEDLE HOLDER, SWEDISH PATTERN, WITH TC, 20,0 CM	137	OVERHOLT-GEISSENDOERFER FIG.4 21.0 CM	110
NEEDLE LARGE	149	OVERHOLT-GEISSENDOERFER FIG.4 27.0 CM	110
NEEDLE MEDIUM	149	OVERHOLT-GEISSENDOERFER FIG.5 21.0 CM	110
NEEDLE SMALL	149	OVERHOLT-GEISSENDOERFER FIG.5 27.0 CM	110
NEGUS GALL DUCT CLAMP FIG.1 19.0 CM	107	OVERHOLT-GEISSENDOERFER FIG.6 21.0 CM	110
NEGUS GALL DUCT CLAMP FIG.2 19.0 CM	107	OVERHOLT-GEISSENDOERFER FIG.6 27.0 CM	110
NEIVERT NEEDLE HOLDER SMOOTH JAWS 13.0CM	124	OVERHOLT-GEISSENDOERFER FIG.7 21.0 CM	110

OVERHOLT-GEISSENDOERFER FIG.7 27,0 CM	110	PRATT FISTULA HOOK 21,0 CM FIG.2	256
OVERHOLT-MIXTER FORCEPS CVD 21,0 CM	108	PRATT FISTULA HOOK 21,0 CM FIG.3	256
PAR TYPE, FINE DISSEC. SCS., SUPERCUT, CURVED, BL/BL, 12,0 CM	58	PRATT HAEMORRHOIDAL FORCEPS 15,0 CM	98
PAR TYPE, FINE DISSEC. SCS., SUPERCUT, STRAIGHT, BL/BL, 12,0 CM	58	PRATT SET OF 8 DILAT. 4.5/5-13.6/14.3MM	272
PARKER RETRACTOR SET SMALL FIG.1+2	168	PRATT UTERINE DILAT.F.37/39, 12.3/13MM	272
PARKER-LANGENBECK US-ARMY SET FIG.1+2	169	PRATT UTERINE DILAT.F.41/43, 13.6/14.3MM	272
PARTSCH BONE CHISEL WIDTH 3 MM 13,5 CM	304	PRATT UTERINE DILAT.FIG.33/35, 11/11.6MM	272
PARTSCH BONE CHISEL WIDTH 4 MM 13,5 CM	304	PRATT UTERINE DILATOR F.17/19,5.6/6.3MM	272
PARTSCH BONE CHISEL WIDTH 5 MM 13,5 CM	304	PRATT UTERINE DILATOR F.29/31,9.6/10.3	272
PARTSCH BONE CHISEL WIDTH 6 MM 13,5 CM	304	PRATT UTERINE DILATORS F.13/15, 4.5/5MM	272
PARTSCH BONE GOUGE WIDTH 3 MM 13,5 CM	304	PRATT UTERINE DILATORS F.21/23, 7/7.6MM	272
PARTSCH BONE GOUGE WIDTH 4 MM 13,5 CM	304	PRATT UTERINE DILATORS F.25/27, 8.3/9MM	272
PARTSCH BONE GOUGE WIDTH 5 MM 13,5 CM	304	PRATT VULSELLUM FORCEPS 4X4 T. 28,0 CM	275
PARTSCH BONE GOUGE WIDTH 6 MM 13,5 CM	304	PRESBYTERIAN CLAMP 16,5 CM	91
PARTSCH MALLET 200GR LEAD FILLED 18,0 CM	306	PRESBYTERIAN TUBING CLAMP 18,0 CM	91
PAYR INT.CRUSHING CLAMP W.PIN 21,0 CM	249	PRESBYTERIAN, TUBING CLAMP, 18,0 CM	91
PAYR INT.CRUSHING CLAMP W.PIN 29,0 CM	249	PRICE-THOMAS FORCEPS 22,0 CM	117
PAYR INT.CRUSHING CLAMP W/O PIN 29,0 CM	249	PRICE-THOMAS FORCEPS 22,0 CM	118
PAYR INT.CRUSHING CLAMP W/O PIN 21,0 CM	249	PRICE-THOMAS FORCEPS 22,0 CM	118
PAYR LIGATURE CONDUCTOR CVD. 22,0 CM	152	PRINCE TONSIL SCISSORS CVD 17,5 CM	36
PAYR LIGATURE CONDUCTOR STR 22,0 CM	152	PROBE + DIRECTOR 11,5 CM 1 MM	214
PAYR-BABY INT.CRUSHING CLAMP 15,0 CM	249	PROBE + DIRECTOR 11,5 CM 2 MM	214
PAYR-BABY INT.CRUSHING CLAMP 15,0 CM	249	PROBE + DIRECTOR 13,0 CM 1 MM	214
PEAN ARTERY FORCEPS STRAIGHT 14,0 CM	99	PROBE + DIRECTOR 13,0 CM 2 MM	214
PEAN ARTERY FORCEPS STRAIGHT 16,0 CM	99	PROBE + DIRECTOR 14,5 CM 1 MM	214
PEAN-DELICATE ART.FCPS.CVD 13,0 CM	105	PROBE + DIRECTOR 14,5 CM 2 MM	214
PEAN-DELICATE ART.FCPS.CVD 16,0 CM	105	PROBE + DIRECTOR 16,0 CM 1 MM	214
PEAN-DELICATE ART.FCPS.STR 13,0 CM	105	PROBE + DIRECTOR 16,0 CM 2 MM	214
PEAN-DELICATE ART.FCPS.STR 16,0 CM	105	PROBE + DIRECTOR 18,0 CM 1 MM	214
PEAN-DELICATE FCPS.CVD 14,0 CM	105	PROBE + DIRECTOR 18,0 CM 2 MM	214
PEAN-DELICATE FCPS.STR 14,0 CM	105	PROBE + DIRECTOR 20,0 CM 1 MM	214
PEDERSON VAGINAL SPECULUM 100X22 MM	260	PROBE + DIRECTOR 20,0 CM 2 MM	214
PEDERSON VAGINAL SPECULUM 120X25 MM	260	PROBE W.EYE 11,5 CM 2 MM	214
PEDERSON VAGINAL SPECULUM 75X13 MM	260	PROBE W.EYE 13,0 CM 2 MM	214
PEERS TOWEL FORCEPS 14,5 CM	88	PROBE W.EYE 14,5 CM 2 MM	214
PELKMANN DRESSING FORCEPS CVD 25,0 CM	89	PROBE W.EYE 16,0 CM 2 MM	214
PELKMANN DRESSING FORCEPS STR 25,0 CM	89	PROBE W.EYE 18,0 CM 2 MM	214
PENNINGTON FORCEPS 15,5 CM	97	PROBE W.EYE 20,0 CM 2 MM	214
PENNINGTON FORCEPS 20,0 CM	97	PYE-SMITH (HARRISON), STERILIZING FORCEPS, 35,0 CM	308
PESTALOZZA, OVUM CURETTE, 30,0 CM	291	QUINKE, LUMBAR PUNCTURE NEEDLE, Ø 0,7 X 50 MM	226
PHANEUF FCPS.CVD 1X2 T 21,5 CM	119	QUINKE, LUMBAR PUNCTURE NEEDLE, Ø 0,7 X 76 MM	226
PHANEUF FCPS.STR 1X2 T 21,5 CM	119	QUINKE, LUMBAR PUNCTURE NEEDLE, Ø 0,7 X 89 MM	226
PIERCE ANTRUM TROCAR W.TUB.CONN. 3,0 MM	220	QUINKE, LUMBAR PUNCTURE NEEDLE, Ø 1,0 X 76 MM	226
PIERCE ANTRUM TROCAR W.TUB.CONN. 4,0 MM	220	QUINKE, LUMBAR PUNCTURE NEEDLE, Ø 1,0 X 89 MM	226
PIERCE ANTRUM TROCAR W.TUB.CONN. 5,0 MM	220	QUINKE, LUMBAR PUNCTURE NEEDLE, Ø 1,2 X 76 MM	226
PIFFARD, LUPUS CURETTE, Ø 3 MM, 14,0 CM	294	QUINKE, LUMBAR PUNCTURE NEEDLE, Ø 1,2 X 89 MM	226
PIFFARD, LUPUS CURETTE, Ø 4 MM, 14,0 CM	294	RADOLF NAIL FORCEPS 13,5CM	296
PIFFARD, LUPUS CURETTE, Ø 5 MM, 14,0 CM	294	RAGNELL, RETRACTOR DOUBLE-ENDED, 8x3/ 16x5 MM, 15,0 CM	163
PIPER, OBSTETRICAL FORCEPS, 44,0 CM	290	RAGNELL-DAVIS RETRACTOR 14,0 CM	163
PLASTER-OF-PARIS SHEARS 20,0 CM	45	RAMPLEY SPONGE HOLDING FORCEPS 18,0 CM	90
PLESTER, RETRACTOR LEFT 11,0 CM	192	RAMPLEY SPONGE HOLDING FORCEPS 25,0 CM	90
PLESTER, RETRACTOR RIGHT 11,0 CM	192	RAMSEY, DRESSING FORCEPS, 18,0 CM	68
PLESTER, SELF-RETAINING RETRACTOR, 2x2 PRONGS, BLUNT, 13,0 CM	192	RAMSEY, TISSUE FCPS., 1X2 TEETH, 18,0 CM	76
PLESTER, SELF-RETAINING RETRACTOR, 2x2 PRONGS, SHARP, 13,0 CM	192	RAMSEY, TISSUE FCPS., 2X3 TEETH, 18,0 CM	76
POOLE SUCTION TUBE CURVED, Ø 6 MM, 22,0 CM	221	RANDALL KIDNEY STONE FCPS FIG.1 23,0 CM	232
POOLE SUCTION TUBE CURVED, Ø 8 MM, 22,0 CM	221	RANDALL KIDNEY STONE FCPS FIG.2 22,0 CM	232
POOLE, SUCTION TUBE, STRAIGHT, Ø 10,0 MM, 22,0CM	221	RANDALL KIDNEY STONE FCPS FIG.3 22,0 CM	232
POOLE, SUCTION TUBE, STRAIGHT, Ø 6,0 MM, 22,0 CM	221	RANDALL KIDNEY STONE FCPS FIG.4 22,0 CM	232
POPEN (FERGUSSON), SUCTION TUBE Ø 2,0 MM, 14,0 CM, LUER ATTACHMENT	223	RANDALL KIDNEY STONE FCPS.FIG.5 19,0 CM	232
POPEN (FERGUSSON), SUCTION TUBE Ø 2,7 MM, 14,0 CM, LUER ATTACHMENT	223	RANDALL KIDNEY STONE FCPS.FIG.6 19,0 CM	232
POPEN (FERGUSSON), SUCTION TUBE Ø 3,3 MM, 14,0 CM, LUER ATTACHMENT	223	RANDALL, SUCTION BIOPSY CURETTE Ø 4,0 MM, 24,0 CM	278
POPEN (FERGUSSON), SUCTION TUBE Ø 4,0 MM, 14,0 CM, LUER ATTACHMENT	223	RECAMIER, UTERINE CURETTE, BLUNT, MALLEABLE, FIG. 0, Ø 6 MM, 31,0 CM	283
POTTS DE MARTEL, VASCULAR SCS. TC, 24,0 CM	53	RECAMIER, UTERINE CURETTE, BLUNT, MALLEABLE, FIG. 00, Ø 5 MM, 31,0 CM	283
POTTS, VASCULAR SCS., SUPERCUT, 25°, SH/SH, 19,0 CM	58	RECAMIER, UTERINE CURETTE, BLUNT, MALLEABLE, FIG. 1, Ø 7 MM, 31,0 CM	283
POTTS, VASCULAR SCS., SUPERCUT, 45°, SH/SH, 19,0 CM	58	RECAMIER, UTERINE CURETTE, BLUNT, MALLEABLE, FIG. 10, Ø 20 MM, 31,0 CM	283
POTTS, VASCULAR SCS., SUPERCUT, 60°, SH/SH, 19,0 CM	58	RECAMIER, UTERINE CURETTE, BLUNT, MALLEABLE, FIG. 2, Ø 8 MM, 31,0 CM	283
POTTS-DE MARTEL, VASCULAR SCISSORS 60°, 21,0 CM	37	RECAMIER, UTERINE CURETTE, BLUNT, MALLEABLE, FIG. 3, Ø 9 MM, 31,0 CM	283
POTTS-DE MARTEL, VASCULAR SCISSORS, 60°, 24,0 CM	37	RECAMIER, UTERINE CURETTE, BLUNT, MALLEABLE, FIG. 4, Ø 11 MM, 31,0 CM	283
POTTS-SMITH, TISSUE FORCEPS, STRAIGHT, 1 X 2 TEETH, 18,0 CM	74	RECAMIER, UTERINE CURETTE, BLUNT, MALLEABLE, FIG. 5, Ø 12 MM, 31,0 CM	283
POTTS-SMITH, DISSECTING SCISSORS, 19,0 CM	42	RECAMIER, UTERINE CURETTE, BLUNT, MALLEABLE, FIG. 6, Ø 14 MM, 31,0 CM	283
POTTS-SMITH, DRESSING FCPS., TC, 15,0 CM	83	RECAMIER, UTERINE CURETTE, BLUNT, MALLEABLE, FIG. 7, Ø 15 MM, 31,0 CM	283
POTTS-SMITH, DRESSING FCPS., TC, 18,0 CM	83	RECAMIER, UTERINE CURETTE, BLUNT, MALLEABLE, FIG. 8, Ø 16 MM, 31,0 CM	283
POTTS-SMITH, DRESSING FCPS., TC, 20,0 CM	83	RECAMIER, UTERINE CURETTE, BLUNT, MALLEABLE, FIG. 9, Ø 19 MM, 31,0 CM	283
POTTS-SMITH, DRESSING FORCEPS, CURVED, 18,0 CM	67	RECAMIER, UTERINE CURETTE, BLUNT, RIGID, FIG. 0, Ø 6 MM, 31,0 CM	283
POTTS-SMITH, DRESSING FORCEPS, CURVED, 21,0 CM	67	RECAMIER, UTERINE CURETTE, BLUNT, RIGID, FIG. 00, Ø 5 MM, 31,0 CM	283
POTTS-SMITH, DRESSING FORCEPS, CURVED, 25,0 CM	67	RECAMIER, UTERINE CURETTE, BLUNT, RIGID, FIG. 1, Ø 7 MM, 31,0 CM	283
POTTS-SMITH, DRESSING FORCEPS, STRAIGHT, 18,0 CM	67	RECAMIER, UTERINE CURETTE, BLUNT, RIGID, FIG. 10, Ø 20 MM, 31,0 CM	283
POTTS-SMITH, DRESSING FORCEPS, STRAIGHT, 21,0 CM	67	RECAMIER, UTERINE CURETTE, BLUNT, RIGID, FIG. 2, Ø 8 MM, 31,0 CM	283
POTTS-SMITH, DRESSING FORCEPS, STRAIGHT, 25,0 CM	67	RECAMIER, UTERINE CURETTE, BLUNT, RIGID, FIG. 3, Ø 9 MM, 31,0 CM	283
POTTS-SMITH, TISSUE FORCEPS, CURVED, 1 X 2 TEETH, 25,0 CM	74	RECAMIER, UTERINE CURETTE, BLUNT, RIGID, FIG. 4, Ø 11 MM, 31,0 CM	283
POTTS-SMITH, TISSUE FORCEPS, CURVED, 1 X 2 TEETH, 18,0 CM	74	RECAMIER, UTERINE CURETTE, BLUNT, RIGID, FIG. 5, Ø 12 MM, 31,0 CM	283
POTTS-SMITH, TISSUE FORCEPS, CURVED, 1 X 2 TEETH, 21,0 CM	74	RECAMIER, UTERINE CURETTE, BLUNT, RIGID, FIG. 6, Ø 14 MM, 31,0 CM	283
POTTS-SMITH, TISSUE FORCEPS, STRAIGHT, 1 X 2 TEETH, 1,0 CM	74	RECAMIER, UTERINE CURETTE, BLUNT, RIGID, FIG. 7, Ø 15 MM, 31,0 CM	283
POTTS-SMITH, TISSUE FORCEPS, STRAIGHT, 1 X 2 TEETH, 25,0 CM	74	RECAMIER, UTERINE CURETTE, BLUNT, RIGID, FIG. 8, Ø 16 MM, 31,0 CM	283
POTTS-SMITH, VASCULAR SCISSORS 25° ANGLED, WITH TC-INSERTS, 19,0 CM	54	RECAMIER, UTERINE CURETTE, BLUNT, RIGID, FIG. 9, Ø 19 MM, 31,0 CM	283
POTTS-SMITH, VASCULAR SCISSORS, 40° ANGLED, WITH TC-INSERTS, 19,0 CM	54	RECAMIER, UTERINE CURETTE, SHARP, MALLEABLE, FIG. 0, Ø 6 MM, 31,0 CM	282
POTTS-SMITH, VASCULAR SCISSORS, 55° BEND, 18,0 CM	37	RECAMIER, UTERINE CURETTE, SHARP, MALLEABLE, FIG. 0, Ø 6 MM, 26,0 CM	280
POTTS-SMITH, VASCULAR SCISSORS, 60° ANGLED, WITH TC-INSERTS, 19,0 CM	54	RECAMIER, UTERINE CURETTE, SHARP, MALLEABLE, FIG. 00, Ø 5 MM, 31,0 CM	282
POZZI, UTERINE TENACULUM FORCEPS, STRONG PATT., 25,0CM	273	RECAMIER, UTERINE CURETTE, SHARP, MALLEABLE, FIG. 00, Ø 5 MM, 26,0 CM	280
PRATT FISTULA HOOK 21,0 CM FIG.1	256	RECAMIER, UTERINE CURETTE, SHARP, MALLEABLE, FIG. 1, Ø 7 MM, 31,0 CM	282

RECAMIER, UTERINE CURETTE, SHARP, MALLEABLE, FIG. 1, Ø7 MM, 26,0 CM	280
RECAMIER, UTERINE CURETTE, SHARP, MALLEABLE, FIG. 10, Ø 20 MM, 31,0 CM	282
RECAMIER, UTERINE CURETTE, SHARP, MALLEABLE, FIG. 2, Ø 8 MM, 31,0 CM	282
RECAMIER, UTERINE CURETTE, SHARP, MALLEABLE, FIG. 2, Ø8 MM, 26,0 CM	280
RECAMIER, UTERINE CURETTE, SHARP, MALLEABLE, FIG. 3, Ø 9 MM, 31,0 CM	282
RECAMIER, UTERINE CURETTE, SHARP, MALLEABLE, FIG. 3, Ø9 MM, 26,0 CM	280
RECAMIER, UTERINE CURETTE, SHARP, MALLEABLE, FIG. 4, Ø 11 MM, 31,0 CM	282
RECAMIER, UTERINE CURETTE, SHARP, MALLEABLE, FIG. 4, Ø11 MM, 26,0 CM	280
RECAMIER, UTERINE CURETTE, SHARP, MALLEABLE, FIG. 5, Ø 12 MM, 31,0 CM	282
RECAMIER, UTERINE CURETTE, SHARP, MALLEABLE, FIG. 5, Ø12 MM, 26,0 CM	280
RECAMIER, UTERINE CURETTE, SHARP, MALLEABLE, FIG. 6, Ø 14 MM, 31,0 CM	282
RECAMIER, UTERINE CURETTE, SHARP, MALLEABLE, FIG. 6, Ø14 MM, 26,0 CM	280
RECAMIER, UTERINE CURETTE, SHARP, MALLEABLE, FIG. 7, Ø 15 MM, 31,0 CM	282
RECAMIER, UTERINE CURETTE, SHARP, MALLEABLE, FIG. 8, Ø 16 MM, 31,0 CM	282
RECAMIER, UTERINE CURETTE, SHARP, MALLEABLE, FIG. 9, Ø 19 MM, 31,0 CM	282
RECAMIER, UTERINE CURETTE, SHARP, RIGID, FIG. 0, Ø 6 MM, 31,0 CM	282
RECAMIER, UTERINE CURETTE, SHARP, RIGID, FIG. 00, Ø 5 MM, 31,0 CM	282
RECAMIER, UTERINE CURETTE, SHARP, RIGID, FIG. 1, Ø 7 MM, 31,0 CM	282
RECAMIER, UTERINE CURETTE, SHARP, RIGID, FIG. 10, Ø 20 MM, 31,0 CM	282
RECAMIER, UTERINE CURETTE, SHARP, RIGID, FIG. 2, Ø 8 MM, 31,0 CM	282
RECAMIER, UTERINE CURETTE, SHARP, RIGID, FIG. 3, Ø 9 MM, 31,0 CM	282
RECAMIER, UTERINE CURETTE, SHARP, RIGID, FIG. 4, Ø 11 MM, 31,0 CM	282
RECAMIER, UTERINE CURETTE, SHARP, RIGID, FIG. 5, Ø 12 MM, 31,0 CM	282
RECAMIER, UTERINE CURETTE, SHARP, RIGID, FIG. 6, Ø 14 MM, 31,0 CM	282
RECAMIER, UTERINE CURETTE, SHARP, RIGID, FIG. 7, Ø 15 MM, 31,0 CM	282
RECAMIER, UTERINE CURETTE, SHARP, RIGID, FIG. 8, Ø 16 MM, 31,0 CM	282
RECAMIER, UTERINE CURETTE, SHARP, RIGID, FIG. 9, Ø 19 MM, 31,0 CM	282
RECAMIER, UTERINE CURETTE, SHARP RIGID FIG. 11, Ø 21 MM, 26,0 CM	280
RECAMIER, UTERINE CURETTE, SHARP RIGID FIG. 12, Ø 23 MM, 26,0 CM	280
RECAMIER, UTERINE CURETTE, SHARP RIGID, FIG. 0, Ø6 MM, 26,0 CM	280
RECAMIER, UTERINE CURETTE, SHARP RIGID, FIG. 00, Ø5 MM, 26,0 CM	280
RECAMIER, UTERINE CURETTE, SHARP RIGID, FIG. 1, Ø7 MM, 26,0 CM	280
RECAMIER, UTERINE CURETTE, SHARP RIGID, FIG. 10, Ø 20 MM, 26,0 CM	280
RECAMIER, UTERINE CURETTE, SHARP RIGID, FIG. 2, Ø8 MM, 26,0 CM	280
RECAMIER, UTERINE CURETTE, SHARP RIGID, FIG. 3, Ø9 MM, 26,0 CM	280
RECAMIER, UTERINE CURETTE, SHARP RIGID, FIG. 4, Ø11 MM, 26,0 CM	280
RECAMIER, UTERINE CURETTE, SHARP RIGID, FIG. 5, Ø12 MM, 26,0 CM	280
RECAMIER, UTERINE CURETTE, SHARP RIGID, FIG. 6, Ø14 MM, 26,0 CM	280
RECAMIER, UTERINE CURETTE, SHARP RIGID, FIG. 7, Ø15 MM, 26,0 CM	280
RECAMIER, UTERINE CURETTE, SHARP RIGID, FIG. 8, Ø16 MM, 26,0 CM	280
RECAMIER, UTERINE CURETTE, SHARP RIGID, FIG. 9, Ø19 MM, 26,0 CM	280
RECTAL, RECTAL SCS., CURVED, BL/BL, 32.5 CM	42
RETRACTOR BLUNT 1 PRONG 16.0 CM	160
RETRACTOR BLUNT 2 PRONGS 16.0 CM	160
RETRACTOR BLUNT 3 PRONGS 16.0 CM	160
RETRACTOR BLUNT 4 PRONGS 16.0 CM	160
RETRACTOR BLUNT FLEX 3 PRONGS 16.0 CM	160
RETRACTOR BLUNT FLEX 4 PRONGS 16.0 CM	160
RETRACTOR BLUNT FLEX.2 PRONGS 16.0 CM	160
RETRACTOR SEMI-SHARP 1 PRONG 16.0 CM	160
RETRACTOR SEMI-SHARP 2 PRONGS 16.0 CM	160
RETRACTOR SEMI-SHARP 3 PRONGS 16.0 CM	160
RETRACTOR SEMI-SHARP 4 PRONGS 16.0 CM	160
RETRACTOR SHARP 1 PRONG 16.0 CM	160
RETRACTOR SHARP 2 PRONGS 16.0 CM	160
RETRACTOR SHARP 3 PRONGS 16.0 CM	160
RETRACTOR SHARP 4 PRONGS 16.0 CM	160
RETRACTOR SHARP FLEX. 2 PRONGS 16.0 CM	160
RETRACTOR SHARP FLEX. 3 PRONGS 16.0 CM	160
RETRACTOR SHARP FLEX. 4 PRONGS 16.0 CM	160
RETRACTOR, 2 PRONG, 14x8 MM, BLUNT, 16,0 CM	162
REVERDIN NEEDLE FIG.1 14.0 CM	145
REVERDIN NEEDLE FIG.1 19.5 CM	145
REVERDIN NEEDLE FIG.1 22.5 CM	145
REVERDIN NEEDLE FIG.2 14.0 CM	145
REVERDIN NEEDLE FIG.2 19.5 CM	145
REVERDIN NEEDLE FIG.2 22.5 CM	145
REVERDIN NEEDLE FIG.3 14.0 CM	145
REVERDIN NEEDLE FIG.3 19.5 CM	145
REVERDIN NEEDLE FIG.3 22.5 CM	145
REVERDIN NEEDLE FIG.4 14.0 CM	145
REVERDIN NEEDLE FIG.4 19.5 CM	145
REVERDIN NEEDLE FIG.4 22.5 CM	145
REVERDIN, ABDOMINAL SPATULA, 280 x 45/60 MM	210
REYNOLDS DISS.SCISSORS CVD SHARP 18.0 CM	26
REYNOLDS DISS.SCISSORS CVD SHARP 20.0 CM	26
REYNOLDS DISS.SCISSORS CVD SHARP 23.0 CM	26
REYNOLDS DISS.SCISSORS STR SHARP 15.0 CM	26
REYNOLDS DISS.SCISSORS STR SHARP 18.0 CM	26
REYNOLDS DISSECTING SCISSORS, CURVED, 15,0 CM	26
REYNOLDS, DISSEC.-SCS. TC, CURVED,16.0CM	51
REYNOLDS, DISSEC.-SCS. TC, STRAIGHT, 15,0 CM	51
REYNOLDS, DISSEC.-SCS., SUPERCUT, STRAIGHT, BL/BL, 12.5 CM	57
REYNOLDS, DISSECTING SCISSORS, POINTED, CURVED, 25,0 CM	26
RIBBON, ABDOMINAL SPATULA, 200 x 12 MM, MALLEABLE	210
RIBBON, ABDOMINAL SPATULA, 200 x 17 MM, MALLEABLE	210
RIBBON, ABDOMINAL SPATULA, 200 x 20 MM, MALLEABLE	210
RIBBON, ABDOMINAL SPATULA, 200 x 25 MM, MALLEABLE	210
RIBBON, ABDOMINAL SPATULA, 200 x 6 MM, MALLEABLE	210
RIBBON, ABDOMINAL SPATULA, 330x13 MM, MALLEABLE	210
RIBBON, ABDOMINAL SPATULA, 330x25 MM, MALLEABLE	210
RIBBON, ABDOMINAL SPATULA, 330X32 MM, MALLEABLE	210
RIBBON, ABDOMINAL SPATULA, 330X40 MM, MALLEABLE	210
RIBBON, ABDOMINAL SPATULA, 330X50 MM, MALLEABLE	210
RICARD ABDOMINAL RETRACTOR 280 MM OPEN.	198
RICARD ABDOMINAL RETRACTOR 300MM OPENING	198
RICARD, ABDOMINAL RETRACTOR, MIDDLE VALVE ONLY, 55X70 MM	200
RICARD, ABDOMINAL RETRACTOR, MIDDLE VALVE ONLY, 65X50 MM	200
RICARD, ABDOMINAL RETRACTOR, MIDDLE VALVE ONLY, 90X80 MM	200
RICHARDSON-EASTMAN RETRACTOR FIG.1 26 CM	178
RICHARDSON-EASTMAN RETRACTOR FIG.1+2	178
RICHARDSON-EASTMAN RETRACTOR FIG.2 28 CM	178
RICHTER OPERATING SCISS. BL/BL 14.5 CM	32
RICHTER RETRACTOR 16.0 CM	196
RICHTER-HEATH CLIP FORCEPS 14.0 CM	154
ROBERTS ARTERY FORCEPS CURVED 22.0 CM	107
ROBERTS ARTERY FORCEPS STRAIGHT 22.0 CM	107
ROBIN-MASSE ABDOMINAL RETRACTOR	199
ROBIN-MASSE, ABDOMINAL RETRACTOR, VALVE ONLY, 40X64 MM	200
ROBIN-MASSE, ABDOMINAL RETRACTOR, VALVE ONLY, 55X65 MM	200
ROBIN-MASSE, ABDOMINAL RETRACTOR, VALVE ONLY, 55X75 MM	200
ROCHARD, ABDOMINAL RETRACTOR, 105X48 MM	209
ROCHARD, ABDOMINAL RETRACTOR, 115X48 MM	209
ROCHARD, ABDOMINAL RETRACTOR, 125X48 MM	209
ROCHARD, ABDOMINAL RETRACTOR, 155X48 MM	209
ROCHARD, ABDOMINAL RETRACTOR, 95X48 MM	209
ROCHARD, FIXATION DEVICE FOR ABDOMINAL RETRACTOR	209
ROCHARD, MOUNTING FRAME WITH 1 ARM	209
ROCHARD, MOUNTING FRAME WITH 2 ARMS	209
ROCHESTER-CARMALT FCPS CVD 16.0 CM	105
ROCHESTER-CARMALT FCPS CVD 20.0 CM	105
ROCHESTER-CARMALT FCPS STR 16.0 CM	105
ROCHESTER-CARMALT FCPS STR 20.0 CM	105
ROCHESTER-PEAN ARTERY FCPS CVD 26.0 CM	106
ROCHESTER-PEAN ARTERY FCPS STR 16.0 CM	106
ROCHESTER-PEAN ARTERY FCPS STR 18.0 CM	106
ROCHESTER-PEAN ARTERY FCPS STR 20.0 CM	106
ROCHESTER-PEAN ARTERY FCPS STR 24.0 CM	106
ROCHESTER-PEAN ARTERY FCPS STR 26.0 CM	106
ROCHESTER-PEAN ARTERY FCPS STR 30.0 CM	106
ROCHESTER-PEAN FCPS CVD 14.0 CM	106
ROCHESTER-PEAN FCPS CVD 16.0 CM	106
ROCHESTER-PEAN FCPS CVD 18.0 CM	106
ROCHESTER-PEAN FCPS CVD 20.0 CM	106
ROCHESTER-PEAN FCPS CVD 22.0 CM	106
ROCHESTER-PEAN FCPS CVD 24.0 CM	106
ROCHESTER-PEAN FCPS CVD 30.0 CM	106
ROCHESTER-PEAN FCPS STR 14.0 CM	106
ROCHESTER-PEAN FCPS STR 22.0 CM	106
ROEDER TOWEL FORCEPS 13.0 CM	86
ROEDER TOWEL FORCEPS 15.0 CM	87
ROGGE STERILIZING FORCEPS 23,0 CM	308
ROUX RETRACTOR FIG.1	167
ROUX RETRACTOR FIG.2	167
ROUX RETRACTOR FIG.3	167
ROUX RETRACTOR SET FIG.1-3	167
ROUX, RETRACTOR, FIG.4	167
RUDD HAEMORRHOIDAL LIGATORS	255
RUMEL DISS.FORCEPS FIG.4, 23.0 CM	109
RUMEL FORCEPS FIG.1, 23.0 CM	109
RUMEL FORCEPS FIG.2, 23.0 CM	109
RUMEL FORCEPS FIG.3, 23.0 CM	109
RUSS.MODEL TISSUE FCPS 15.0 CM	74
RUSS.MODEL TISSUE FCPS 20.0 CM	74
RUSS.MODEL TISSUE FORCEPS 25.0 CM	74
RYDER/FRENCH-EYE NEEDLE HOLDER TC 13 CM	137
RYDER/FRENCH-EYE NEEDLE HOLDER TC 15 CM	137
RYDER/FRENCH-EYE NEEDLE HOLDER TC 18 CM	137
RYDER/FRENCH-EYE NEEDLE HOLDER TC 20 CM	137
RYDER/FRENCH-EYE NEEDLE HOLDER TC 23 CM	137
RYDER/FRENCH-EYE NEEDLE HOLDER TC 26 CM	137
SAALFELD, COMEDO EXTRACTOR, 10,0 CM	295
SAALFELD, COMEDO EXTRACTOR, 14,0 CM	295
SAENGER OVUM FORCEPS, CURVED, 27.0CM	291
SANVENERO SCISSORS CVD SH/SH 14.0 CM	27
SANVENERO SCISSORS STR SH/SH 14.0 CM	27
SAROT ARTERY FORCEPS CVD 24.0 CM	107
SAROT ARTERY FORCEPS STR 24.0 CM	107
SAROT NEEDLE HOLDER TC 18.0 CM	134
SAROT NEEDLE HOLDER TC 26.0 CM	134
SAROT, NEEDLE HOLDER WITH TC, 20,0 CM	134
SATINSKY ARTERY SCISSORS S-SHAPED 24.5CM	39
SAUERBRUCH RETRACTOR 44X16 MM 22.5 CM	176
SAUERBRUCH RETRACTOR 55X22 MM 22.5 CM	176
SAUERBRUCH RETRACTOR 72X19 MM 22.5 CM	176
SAW BLADE ONLY FOR KA 910/17, 20MM	296
SAW BLADE ONLY, FOR 186-420-17, Ø 30 MM	296
SCALP-CONTOUR RETRACTOR BLUNT 14.0 CM	189
SCALP-CONTOUR RETRACTOR SHARP 14.0 CM	189
SCALPEL HANDLE NO.3	2

SCALPEL HANDLE NO.3 L CHR.	2	SIMPSON-BRAUN, OBSTETRICAL FORCEPS, 33,0 CM	289
SCALPEL HANDLE NO.4	3	SIMPSON-BRAUN, OBSTETRICAL FORCEPS, 36,0 CM	289
SCALPEL HANDLE NO.4 L	3	SIMPSON-LUIKART, OBSTETRICAL FORCEPS, 36,0 CM,	289
SCALPEL HANDLE NO.7	2	SIMS GYNEC. SCISSORS CVD BL/BL 23.0 CM	40
SCALPEL HANDLE NO.7K	2	SIMS GYNEC. SCISSORS CVD SH/BL 20.0 CM	40
SCALPEL HANDLE, HOLLOW, NO.8	3	SIMS GYNEC. SCISSORS CVD SH/BL 23.0 CM	40
SCALPEL HANDLE, HOLLOW, NO.9	3	SIMS GYNEC. SCISSORS CVD SH/SH 23.0 CM	40
SCALPEL HANDLE, NO.3 WITH SCALE	2	SIMS GYNEC. SCISSORS STR BL/BL 20.0 CM	39
SCHAEDEL TOWEL FORCEPS 9,0 CM	86	SIMS GYNEC. SCISSORS STR BL/BL 23.0 CM	39
SCHAMBERG, COMEDO EXTRACTOR, 10,0 CM	295	SIMS GYNEC. SCISSORS STR BL/BL 23.0 CM	39
SCHEDE, BONE CURETTE, FIG.0, 17,0 CM	298	SIMS GYNEC. SCISSORS STR SH/BL 20.0 CM	39
SCHEDE, BONE CURETTE, FIG.00, 17,0 CM	298	SIMS GYNEC. SCISSORS STR SH/BL 23.0 CM	39
SCHEDE, BONE CURETTE, FIG.000, 17,0 CM	298	SIMS GYNEC. SCISSORS STR SH/SH 20.0 CM	39
SCHEDE, BONE CURETTE, FIG.1, 17,0 CM	298	SIMS RECTAL SPECULA FENESTRATED 15,0 CM	252
SCHEDE, BONE CURETTE, FIG.2, 17,0 CM	298	SIMS RECTAL SPECULA FULL BLADES 15,0 CM	252
SCHEDE, BONE CURETTE, FIG.3, 17,0 CM	298	SIMS SCISSORS CVD BL/BL 20.0 CM	40
SCHEDE, BONE CURETTE, FIG.4, 17,0 CM	298	SIMS SCISSORS CVD SH/SH 20.0 CM	40
SCHERBAK VAGINAL SPECULA BLADE ONLY, FIG. 1, 80 X 30 MM	261	SIMS UTERINE PROBE MALLEABLECM*32.0 CM*	277
SCHERBAK VAGINAL SPECULA, SET COMPLETE	261	SIMS UTERINE PROBE RIGID CM 32.0 CM	277
SCHERBAK, VAGINAL SPECULA WEIGHT ONLY, 800G	261	SIMS VAG. SPECULUM DOUBLE 60X25+30 MM	267
SCHERBAK, VAGINAL SPECULA BLADE ONLY, FIG. 2, 85 X 35 MM	261	SIMS VAG. SPECULUM DOUBLE 70X30+35 MM	267
SCHERBAK, VAGINAL SPECULA BLADE ONLY, FIG. 3, 90 X 40 MM	261	SIMS VAG. SPECULUM DOUBLE 80X35+40 MM	267
SCHERBAK, VAGINAL SPECULA BLADE ONLY, FIG. 4, 40/60X55 MM	261	SIMS, GYN.- SCISSORS TC, STRAIGHT, BL/BL, 23.0 CM	52
SCHERBAK, VAGINAL SPECULA BLADE ONLY, FIG. 5, 45/70 X 70 MM	261	SIMS, GYN.- SCISSORS TC, STRAIGHT, BL/BL, 20.0 CM	52
SCHERBAK, VAGINAL SPECULA HANDLE ONLY	261	SIMS, GYN.-SCISSORS TC, CURVED, BL/BL, 20.0 CM	52
SCHERBAK, VAGINAL SPECULA, WEIGHT ONLY, 400G	261	SIMS, GYN.-SCISSORS TC, CURVED, BL/BL, 23.0 CM	52
SCHINK, DERMATOME, SPARE BLADES ONLY	11	SIMS, GYN.-SCISSORS TC, CURVED, SH/BL, 20.0 CM	52
SCHINK, DERMATOME, 30.0 CM	11	SIMS, GYN.-SCISSORS TC, CURVED, SH/BL, 23.0 CM	52
SCHINK, DERMATOMES, SKIN STRAIGHTENING PLATE ONLY	10	SIMS, GYN.-SCISSORS TC, CURVED, SH/SH, 20.0 CM	52
SCHMID NEEDLE 15,0 CM 3MM	224	SIMS, GYN.-SCISSORS TC, CURVED, SH/SH, 23.0 CM	52
SCHMID NEEDLE 15,0 CM 4 MM	224	SIMS, GYN.-SCISSORS TC, STRAIGHT, SH/BL, 20.0 CM	52
SCHMID NEEDLE 15,0 CM 5 MM	224	SIMS, GYN.-SCISSORS TC, STRAIGHT, SH/BL, 23.0 CM	52
SCHMID NEEDLE 15,0 CM 6 MM	224	SIMS, GYN.-SCISSORS TC, STRAIGHT, SH/SH, 20.0 CM	52
SCHMIEDEN LIGATURE CONDUCTOR 19,0 CM	152	SIMS, GYN.-SCISSORS TC, STRAIGHT, SH/SH, 23.0 CM	52
SCHMIEDEN LIGATURE NEEDLE 21,0 CM	148	SIMS, UTERINE CURETTE, BLUNT, MALLEABLE, FIG. 0, Ø 6 MM, 26,0 CM	281
SCHMIEDEN-PAYR LIGATURE CONDUCTOR 19,0CM	152	SIMS, UTERINE CURETTE, BLUNT, MALLEABLE, FIG. 00, Ø 5 MM, 26,0 CM	281
SCHMIEDEN-TAYLOR DURA SCISSORS 17,0 CM	35	SIMS, UTERINE CURETTE, BLUNT, MALLEABLE, FIG. 1, Ø 7 MM, 26,0 CM	281
SCHROEDER FCPS CVD 24,0 CM, 2X2	274	SIMS, UTERINE CURETTE, BLUNT, MALLEABLE, FIG. 10, Ø 20 MM, 26,0 CM	281
SCHROEDER FORCEPS BOX LOCK, 25,0 CM	273	SIMS, UTERINE CURETTE, BLUNT, MALLEABLE, FIG. 2, Ø 8 MM, 26,0 CM	281
SCHROEDER VULSELLUM FCPS STR 2X2T 24,0CM	274	SIMS, UTERINE CURETTE, BLUNT, MALLEABLE, FIG. 3, Ø 9 MM, 26,0 CM	281
SCHUBERT, CERV. BIOPSY+SPEC. FCPS 26,0 CM	287	SIMS, UTERINE CURETTE, BLUNT, MALLEABLE, FIG. 4, Ø 11 MM, 26,0 CM	281
SCHUBERT, CERVICAL BIOPSY FORCEPS, 21,0 CM	286	SIMS, UTERINE CURETTE, BLUNT, MALLEABLE, FIG. 5, Ø 12 MM, 26,0 CM	281
SCHUBERT, CERVICAL BIOPSY FORCEPS, 29 CM	286	SIMS, UTERINE CURETTE, BLUNT, MALLEABLE, FIG. 6, Ø 14 MM, 26,0 CM	281
SCHUMACHER CERVICAL BIOPSY+SPEC. FCPS 5MM	287	SIMS, UTERINE CURETTE, BLUNT, MALLEABLE, FIG. 7, Ø 15 MM, 26,0 CM	281
SCHUMACHER CERVICAL BIOPSY+SPEC. FCPS 7MM	287	SIMS, UTERINE CURETTE, BLUNT, MALLEABLE, FIG. 8, Ø 16 MM, 26,0 CM	281
SCHUMACHER UMBILICAL SCISSORS 16,0 CM	43	SIMS, UTERINE CURETTE, BLUNT, MALLEABLE, FIG. 9, Ø 19 MM, 26,0 CM	281
SCHUMACHER-VAN DOREN FCPS FIG.1	286	SIMS, UTERINE CURETTE, BLUNT, RIGID, FIG. 0, Ø 6 MM, 26,0 CM	281
SCUDDER INTEST. CLAMP FCPS. CVD. 33,0 CM	250	SIMS, UTERINE CURETTE, BLUNT, RIGID, FIG. 00, Ø 5 MM, 26,0 CM	281
SCUDDER INTEST. CLAMP FCPS. STR. 33,0 CM	250	SIMS, UTERINE CURETTE, BLUNT, RIGID, FIG. 1, Ø 7 MM, 26,0 CM	281
SEDILLOT, RASPARTORY FINGER RING HANDLE, 15 MM, 21,0 CM	303	SIMS, UTERINE CURETTE, BLUNT, RIGID, FIG. 10, Ø 20 MM, 26,0 CM	281
SEGOND MYOMA KNIFE, 27,0CM	279	SIMS, UTERINE CURETTE, BLUNT, RIGID, FIG. 2, Ø 8 MM, 26,0 CM	281
SELDINGER-STILLE, BIOPSY-CANNULA, Ø 1,6 x 70 MM	225	SIMS, UTERINE CURETTE, BLUNT, RIGID, FIG. 3, Ø 9 MM, 26,0 CM	281
SELDINGER-STILLE, BIOPSY-CANNULA, Ø 2,0 x 70 MM	225	SIMS, UTERINE CURETTE, BLUNT, RIGID, FIG. 4, Ø 11 MM, 26,0 CM	281
SEMB BRONCHUS CLAMPS 22,0 CM	118	SIMS, UTERINE CURETTE, BLUNT, RIGID, FIG. 5, Ø 12 MM, 26,0 CM	281
SEMB BRONCHUS CLAMPS 22,0 CM	118	SIMS, UTERINE CURETTE, BLUNT, RIGID, FIG. 6, Ø 14 MM, 26,0 CM	281
SEMKEN TISSUE FCPS STR 1X2 TEETH 12,5CM	73	SIMS, UTERINE CURETTE, BLUNT, RIGID, FIG. 7, Ø 15 MM, 26,0 CM	281
SEMKEN TISSUE FCPS STR 2X3 TEETH 12,0cm	73	SIMS, UTERINE CURETTE, BLUNT, RIGID, FIG. 8, Ø 16 MM, 26,0 CM	281
SEMKEN, DRESSING FORCEPS STRAIGHT, 12,5 CM	67	SIMS, UTERINE CURETTE, BLUNT, RIGID, FIG. 9, Ø 19 MM, 26,0 CM	281
SEMKEN, DRESSING FORCEPS STRAIGHT, 15,0 CM	67	SIMS, UTERINE CURETTE, SHARP, MALLEABLE, FIG. 10, Ø 20 MM, 26,0 CM	280
SEMKEN, TISSUE FCPS, 1X2 TEETH, TC, 12,5 CM	82	SIMS, UTERINE CURETTE, SHARP, MALLEABLE, FIG. 7, Ø 15 MM, 26,0 CM	280
SEMKEN, TISSUE FCPS, 1X2 TEETH, TC, 15,5 CM	82	SIMS, UTERINE CURETTE, SHARP, MALLEABLE, FIG. 8, Ø 16 MM, 26,0 CM	280
SEMKEN, TISSUE FORCEPS, STRAIGHT, 1 X 2 TEETH, 15,0 CM	73	SIMS, UTERINE CURETTE, SHARP, MALLEABLE, FIG. 9, Ø 19 MM, 26,0 CM	280
SEMM VAGINAL SPECULA 100X17/20MM	260	SIMS, VAGINAL SPECULA, DOUBLE, 102X44 / 95X38 MM	266
SEMM VAGINAL SPECULA 100X25/30MM	260	SIMS, VAGINAL SPECULA, DOUBLE, 76X25 / 70X22 MM	266
SEMM VAGINAL SPECULA 90X14/18MM	260	SIMS, VAGINAL SPECULA, DOUBLE, 82X30 / 76X25 MM	266
SEMM, ABDOMINAL RETRACTOR, FRAME ONLY, 275X250 MM	207	SIMS, VAGINAL SPECULA, DOUBLE, 95X38 / 82X30 MM	266
SEMM, ABDOMINAL RETRACTOR, VALVE ONLY, 105X35 MM	208	SINGLEY-TUTTLE GRASPING FORCEPS 23,0 CM	68
SEMM, ABDOMINAL RETRACTOR, VALVE ONLY, 47X65 MM	208	SKENE, UTERINE TENACULUM FORCEPS, 24,0 CM	274
SEMM, ABDOMINAL RETRACTOR, VALVE ONLY, 50X54 MM	208	SMITH (MOD.USA) BANDAGE SCISSORS 16,0 CM	45
SEMM, ABDOMINAL RETRACTOR, VALVE ONLY, 76X98 MM	208	SMITH (MOD.USA) BANDAGE SCISSORS 18,0 CM	45
SEMM, ABDOMINAL RETRACTOR, VALVE ONLY, 98X52 MM	208	SMITH (MOD.USA) BANDAGE SCISSORS 20,0 CM	45
SENN-GREEN RETRACTOR 10X6 MM 15,0 CM	162	SMITH (MOD.USA) BANDAGE SCISSORS 23,0 CM	45
SENN-GREEN RETRACTOR 20X6 MM 15,0 CM	162	SMITH-BUIE ANAL RETRACTOR 75X23MM 15,0CM	252
SENN-MILLER RETRACTOR BLOUNT 16,0 CM	163	SMITH-PETERSEN GOUGE 14MM	306
SENN-MILLER RETRACTOR SHARP 16,0 CM	163	SMITH-PETERSEN GOUGE 14MM	306
SETTING FORCEPS F.BULLDOG CLAMPS 23,0 CM	94	SMITH-PETERSEN GOUGE 16MM	306
SIEBOLD GYNEC. SCS S-CURVED BL/BL 24,0 CM	40	SMITH-PETERSEN GOUGE 16MM	306
SILVER, DERMATOMES, 19,0 CM	11	SMITH-PETERSEN GOUGE 19MM	306
SILVER, DERMATOMES, SPARE BLADES ONLY	11	SMITH-PETERSEN GOUGE 19MM	306
SIMON FISTULA HOOK 2 PRONGS 22,0 CM	279	SMITH-PETERSEN GOUGE 25MM	306
SIMON UTERINE SCOOP, FIG. 1, 25CM	286	SMITH-PETERSEN GOUGE 25MM	306
SIMON UTERINE SCOOP, FIG. 2, 25CM	286	SMITH-PETERSEN GOUGE 9MM	306
SIMON UTERINE SCOOP, FIG. 3, 25CM	286	SMITH-PETERSEN GOUGE 9MM	306
SIMON UTERINE SCOOP, FIG. 4, 25CM	286	SMITH-PETERSEN OSTEOTOME 13MM	305
SIMON UTERINE SCOOP, FIG. 5, 25CM	286	SMITH-PETERSEN OSTEOTOME 13MM	305
SIMON UTERINE SCOOP, FIG. 6, 25CM	286	SMITH-PETERSEN OSTEOTOME 16MM	305
SIMON, RETRACTOR, 115 x 22 MM, 28,0 CM	180	SMITH-PETERSEN OSTEOTOME 16MM	305
SIMON, RETRACTOR, 115 x 27 MM, 28,0 CM	180	SMITH-PETERSEN OSTEOTOME 19MM	305
SIMPSON, OBSTETRICAL FORCEPS, 30,0 CM	289	SMITH-PETERSEN OSTEOTOME 19MM	305
SIMPSON, UTERINE PROBE, MALLEABLE, 29,0 CM	277	SMITH-PETERSEN OSTEOTOME 25MM	305

SMITH-PETERSEN OSTEOTOME 25MM	305	STANDARD OPER.SCS. CVD.SH/BL 16.5 CM	14
SMITH-PETERSEN OSTEOTOME 32MM	305	STANDARD OPER.SCS. CVD.SH/BL 18.5 CM	14
SMITH-PETERSEN OSTEOTOME 32MM	305	STANDARD OPER.SCS. CVD.SH/BL 20.0 CM	14
SMITH-PETERSEN OSTEOTOME 6MM	305	STANDARD OPER.SCS. CVD.SH/SH 11.5 CM	15
SMITH-PETERSEN OSTEOTOME 6MM	305	STANDARD OPER.SCS. CVD.SH/SH 13.0 CM	15
SMITH-PETERSEN OSTEOTOME 9MM	305	STANDARD OPER.SCS. CVD.SH/SH 14.5 CM	15
SMITH-PETERSEN OSTEOTOME 9MM	305	STANDARD OPER.SCS. CVD.SH/SH 15.5 CM	15
SOLUTION BOWL 165 x 60 MM	309	STANDARD OPER.SCS. CVD.SH/SH 16.5 CM	15
SOLUTION BOWL 175 x 70 MM	309	STANDARD OPER.SCS. STR.BL/BL 20.0 CM	14
SOLUTION BOWL 220 x 80 MM	309	STANDARD OPER.SCS. STR.SH/BL 17.5 CM	14
SOLUTION BOWL 225 x 90 MM	309	STANDARD OPER.SCS. STR.SH/SH 10.5 CM	15
SOLUTION BOWL 240 x 110 MM	309	STANDARD OPER.SCS. STR.SH/SH 17.5 CM	15
SOLUTION BOWL 275 x 115 MM	309	STANDARD OPER.SCS. STR.SH/SH 18.5 CM	15
SOLUTION BOWL 290 x 125 MM	309	STANDARD OPER.SCS. STR.SH/SH 20.0 CM	15
SOLUTION BOWL 310 x 120 MM	309	STANDARD OPER.SCS. STR.BL/BL 18.5 CM	14
SOLUTION BOWL 345 x 125 MM	309	STANDARD OPER.SCS. STR.BL/BL 10.5 CM	14
SOLUTION BOWL 380 x 130 MM	309	STANDARD OPER.SCS. STR.BL/BL 13.0 CM	14
SOMER, UTERINE ELEVATING FORCEPS, 23.0 CM	276	STANDARD OPER.SCS. STR.BL/BL 14.5 CM	14
SPENCER, LIGATURE SCISSORS, 10.5 CM	33	STANDARD OPER.SCS. STR.BL/BL 15.5 CM	14
SPENCER, LIGATURE SCISSORS, 9.0 CM	33	STANDARD OPER.SCS. STR.BL/BL 16.5 CM	14
SPENCER, LIGATURE SCISSORS, 12.5 CM	33	STANDARD OPER.SCS. STR.SH/BL 10.5 CM	14
SPENCER-WELLS, ART.FCPS.CVD 13.0 CM	99	STANDARD OPER.SCS. STR.SH/BL 11.5 CM	14
SPENCER-WELLS, ART.FCPS.CVD 15.5 CM	99	STANDARD OPER.SCS. STR.SH/BL 13.0 CM	14
SPENCER-WELLS, ART.FCPS.STR 13.0 CM	99	STANDARD OPER.SCS. STR.SH/BL 14.5 CM	14
SPENCER-WELLS, ART.FCPS.STR 15.5 CM	99	STANDARD OPER.SCS. STR.SH/BL 15.5 CM	14
SPENCER-WELLS, ARTERY FCPS CVD 20.0 CM	99	STANDARD OPER.SCS. STR.SH/BL 16.5 CM	14
SPENCER-WELLS, ARTERY FCPS STR 20.0 CM	99	STANDARD OPER.SCS. STR.SH/BL 18.5 CM	14
SPENCER-WELLS, ARTERY FCPS. STR 18.0 CM	99	STANDARD OPER.SCS. STR.SH/BL 20.0 CM	14
SPENCER-WELLS, ARTERY FORCEPS CURVED, 18.0 CM	99	STANDARD OPER.SCS. STR.SH/SH 11.5 CM	15
SPLINTER FCPS CVD SERRAT 9.0 CM	77	STANDARD OPER.SCS. STR.SH/SH 13.0 CM	15
SPLINTER FCPS CVD SERRAT.10.5 CM	77	STANDARD OPER.SCS. STR.SH/SH 14.5 CM	15
SPLINTER FCPS CVD SERRAT.11.5 CM	77	STANDARD OPER.SCS. STR.SH/SH 15.5 CM	15
SPLINTER FCPS CVD SERRAT.13.0 CM	77	STANDARD OPER.SCS. STR.SH/SH 16.5 CM	15
SPLINTER FCPS CVD SERRAT.14.5 CM	77	STANDARD SCS TC CVD BL/BL 14.5 CM	46
SPLINTER FCPS CVD SERRAT.8.0 CM	77	STANDARD SCS TC CVD BL/BL 16.5 CM	46
SPLINTER FCPS WITH PIN SERRAT CVD 8.0 CM	77	STANDARD SCS TC CVD BL/BL 18.5 CM	46
SPLINTER FCPS WITH PIN SERRAT CVD 9.0 CM	77	STANDARD SCS TC CVD SH/BL 14.5 CM	46
SPLINTER FCPS WITH PIN SERRAT CVD10.5 CM	77	STANDARD SCS TC CVD SH/BL 16.5 CM	46
SPLINTER FCPS WITH PIN SERRAT CVD11.5 CM	77	STANDARD SCS TC CVD SH/BL 18.5 CM	46
SPLINTER FCPS WITH PIN SERRAT CVD13.0 CM	77	STANDARD SCS TC CVD SH/SH 14.5 CM	46
SPLINTER FCPS WITH PIN SERRAT CVD14.5 CM	77	STANDARD SCS TC CVD SH/SH 16.5 CM	46
SPLINTER FCPS WITH PIN SERRAT STR 8.5 CM	77	STANDARD SCS TC CVD SH/SH 18.5 CM	46
SPLINTER FCPS WITH PIN SERRAT STR 9.0 CM	77	STANDARD SCS TC STR BL/BL 16.5 CM	46
SPLINTER FCPS WITH PIN SERRAT STR10.5 CM	77	STANDARD SCS TC STR BL/BL 18.5 CM	46
SPLINTER FCPS WITH PIN SERRAT STR11.5 CM	77	STANDARD SCS TC STR SH/BL 14.5 CM	46
SPLINTER FCPS WITH PIN SERRAT STR13.0 CM	77	STANDARD SCS TC STR SH/BL 16.5 CM	46
SPLINTER FCPS WITH PIN SERRAT STR14.5 CM	77	STANDARD SCS TC STR SH/BL 18.5 CM	46
SPLINTER FCPS. SERRAT STR 10.5CM	77	STANDARD SCS TC STR SH/SH 14.5 CM	46
SPLINTER FCPS. SERRAT STR 11.5 CM	77	STANDARD SCS TC STR SH/SH 16.5 CM	46
SPLINTER FCPS. SERRAT STR 13.0CM	77	STANDARD SCS TC STR SH/SH 18.5 CM	46
SPLINTER FCPS. SERRAT STR 14.5 CM	77	STANDARD TISSUE FCPS., WITH PIN, 1X2 T STR 13.0 CM	70
SPLINTER FCPS. SERRAT STR 8.0 CM	77	STANDARD TISSUE FCPS., WITH PIN, 1X2 T STR 14.5 CM	70
SPLINTER FCPS. SERRAT STR 9.0 CM	77	STANDARD TISSUE FCPS., WITH PIN, 1X2 T STR 15.0 CM	70
SPLINTER FORCEPS, ANGLED, 10.0 CM	78	STANDARD TISSUE FCPS., WITH PIN, 1X2 T STR 16.0 CM	70
SPLINTER FORCEPS, STRAIGHT, 10.0 CM	78	STANDARD TISSUE FCPS., WITH PIN, 1X2 T STR 18.0 CM	70
ST.MARKS, RETRACTOR, FIG.1, 29.0 CM	186	STANDARD TISSUE FCPS., WITH PIN, 1X2 T STR 20.0 CM	70
ST.MARKS, RETRACTOR, FIG.2, 32.5 CM	186	STANDARD TISSUE FCPS., WITH PIN, 1X2 T STR 25.0 CM	70
ST.MARKS, RETRACTOR, FIG.3, 29.0 CM	186	STANDARD TISSUE FCPS., WITH PIN, 1X2 T STR 30.0 CM	70
ST.MARKS, RETRACTOR, FIG.4, 32.5 CM	186	STANDARD TROCER, W. SHIELD A. STOPCOCK, Ø 3.0 MM, 12,0 CM	218
STACKE EAR PROBE 1 MM DIAMETER 10.5 CM	214	STANDARD TROCER, W. SHIELD A. STOPCOCK, Ø 3.5 MM, 12,0 CM	218
STANDARD DRESSING FORCEPS STR 10.5 CM	64	STANDARD TROCER, W. SHIELD A. STOPCOCK, Ø 4.0 MM, 12,0 CM	218
STANDARD DRESSING FORCEPS STR 11.5 CM	64	STANDARD TROCER, W. SHIELD A. STOPCOCK, Ø 4.5 MM, 12,0 CM	218
STANDARD DRESSING FORCEPS STR 13.0 CM	64	STANDARD TROCER, W. SHIELD A. STOPCOCK, Ø 5.0 MM, 12,0 CM	218
STANDARD DRESSING FORCEPS STR 14.5 CM	64	STANDARD TROCER, W. SHIELD A. STOPCOCK, Ø 5.5 MM, 12,0 CM	218
STANDARD DRESSING FORCEPS STR 15.0 CM	64	STANDARD TROCER, W. SHIELD A. STOPCOCK, Ø 6.0 MM, 12,0 CM	218
STANDARD DRESSING FORCEPS STR 16.0 CM	64	STANDARD TROCER, W. SHIELD, Ø 3.0 MM, 11,0 CM	218
STANDARD DRESSING FORCEPS STR 18.0 CM	64	STANDARD TROCER, W. SHIELD, Ø 3.5 MM, 11,0 CM	218
STANDARD DRESSING FORCEPS STR 20.0 CM	64	STANDARD TROCER, W. SHIELD, Ø 4.0 MM, 11,0 CM	218
STANDARD DRESSING FORCEPS STR 25.0 CM	64	STANDARD TROCER, W. SHIELD, Ø 4.5 MM, 11,0 CM	218
STANDARD DRESSING FORCEPS STR 30.0 CM	64	STANDARD TROCER, W. SHIELD, Ø 5.0 MM, 11,0 CM	218
STANDARD OPER.SCS CVD SH/BL 10.5 CM	14	STANDARD TROCER, W. SHIELD, Ø 5.5 MM, 11,0 CM	218
STANDARD OPER.SCS CVD SH/BL 13.0 CM	14	STANDARD TROCER, W. SHIELD, Ø 6.0 MM, 11,0 CM	218
STANDARD OPER.SCS CVD SH/BL 17.5 CM	14	STANDARD TROCER, W. SHIELD, STOPCOCK A.TUBE, Ø 3.0 MM, 12,0 CM	218
STANDARD OPER.SCS STR. BL/BL 17.5 CM	14	STANDARD TROCER, W. SHIELD, STOPCOCK A.TUBE, Ø 3.5 MM, 12,0 CM	218
STANDARD OPER.SCS. CVD BL/BL 10.5 CM	14	STANDARD TROCER, W. SHIELD, STOPCOCK A.TUBE, Ø 4.0 MM, 12,0 CM	218
STANDARD OPER.SCS. CVD BL/BL 11.5 CM	14	STANDARD TROCER, W. SHIELD, STOPCOCK A.TUBE, Ø 4.5 MM, 12,0 CM	218
STANDARD OPER.SCS. CVD BL/BL 17.5 CM	14	STANDARD TROCER, W. SHIELD, STOPCOCK A.TUBE, Ø 5.0 MM, 12,0 CM	218
STANDARD OPER.SCS. CVD SH/SH 10.5 CM	15	STANDARD TROCER, W. SHIELD, STOPCOCK A.TUBE, Ø 5.5 MM, 12,0 CM	218
STANDARD OPER.SCS. CVD SH/SH 17.5 CM	15	STANDARD TROCER, W. SHIELD, STOPCOCK A.TUBE, Ø 6.0 MM, 12,0 CM	218
STANDARD OPER.SCS. CVD SH/SH 18.5 CM	15	STAUDE-MOORE, UTERINE TENACULUM FORCEPS, 17.0 CM	272
STANDARD OPER.SCS. CVD SH/SH 20.0 CM	15	STELZNER, LOBECTOMY AND RECTAL SCS., CURVED, BL/BL, 31.0 CM	42
STANDARD OPER.SCS. CVD.BL/BL 13.0 CM	14	STELZNER, LOBECTOMY AND RECTAL SCS., STRAIGHT, BL/BL, 31.0 CM	42
STANDARD OPER.SCS. CVD.BL/BL 14.5 CM	14	STERILIZING FORCEPS, 20.0 CM	308
STANDARD OPER.SCS. CVD.BL/BL 15.5 CM	14	STEVENS TENOTOM.SCS BLUNT CVD 10.5 CM	31
STANDARD OPER.SCS. CVD.BL/BL 16.5 CM	14	STEVENS TENOTOM.SCS BLUNT STR 10.5 CM	31
STANDARD OPER.SCS. CVD.BL/BL 18.5 CM	14	STEVENS TENOTOM.SCS POINTED CVD 10.5 CM	31
STANDARD OPER.SCS. CVD.BL/BL 20.0 CM	14	STEVENS TENOTOM.SCS POINTED STR 10.5 CM	31
STANDARD OPER.SCS. CVD.SH/BL 11.5 CM	14	STEVENS TENOTOM.SCS.CVD POINTED 11.5 CM	31
STANDARD OPER.SCS. CVD.SH/BL 14.5 CM	14	STEVENS TENOTOM.SCS.STR BLUNT 11.5 CM	31
STANDARD OPER.SCS. CVD.SH/BL 15.5 CM	14	STEVENS TENOTOM.SCS.STR POINTED 11.5CM	31

STEVENS, MICRO-SCISSORS, BAJONETT SHAPED HANDLE, 45° ANGLED, SH/SH, 18,5 CM	59	THOREK, DISSECTING SCISSORS, CURVED, 25,0 CM	27
STEVENS, MICRO-SCISSORS, BAJONETT SHAPED HANDLE, 45° ANGLED, SH/SH, 22,5 CM	59	THREE-WAY-STOPCOCK, 3 X LUER-LOCK FEMALE	229
STEVENS, MICRO-SCISSORS, BAJONETT SHAPED HANDLE, CURVED, LANCETTE SH/SH, 22,5 CM	59	TISCHLER-KEVORKIAN, CERVICAL BIOPSY FORCEPS	288
STEVENS, MICRO-SCISSORS, BAJONETT SHAPED HANDLE, CURVED, LANCETTESH/SH, 18,5 CM	59	TISCHLER-MORGAN, CERVICAL BIOPSY AND SPECIMEN FORCEPS, 21,0 CM	288
STEVENS, MICRO-SCISSORS, BAJONETT SHAPED HANDLE, LEFT CVD., SH/SH, 18,5 CM	59	TISSUE FCPS., DELICATE, CURVED, WITH PIN, 1X2 T STR 13,0 CM	70
STEVENS, MICRO-SCISSORS, BAJONETT SHAPED HANDLE, LEFT CVD., SH/SH, 22,5 CM	59	TISSUE FCPS., DELICATE, CURVED, WITH PIN, 1X2 T STR 14,5 CM	70
STEVENS, MICRO-SCISSORS, BAJONETT SHAPED HANDLE, RIGHT CVD., SH/SH, 18,5 CM	59	TISSUE FCPS., DELICATE, CURVED, WITH PIN, 1X2 T STR 16,0 CM	70
STEVENS, MICRO-SCISSORS, BAJONETT SHAPED HANDLE, RIGHT CVD., SH/SH, 22,5 CM	59	TISSUE FCPS., DELICATE, CURVED, WITH PIN, 1X2 T STR 18,0 CM	70
STEVENS, MICRO-SCISSORS, BAJONETT SHAPED HANDLE, STRAIGHT, LANCETTE SH/SH, 18,5 CM	59	TISSUE FCPS., DELICATE, CURVED, WITH PIN, 1X2 T STR 20,0 CM	70
STEVENS, MICRO-SCISSORS, BAJONETT SHAPED HANDLE, STRAIGHT, LANCETTE SH/SH, 22,5 CM	59	TISSUE FORCEPS 2X3 TEETH STR 11,5 CM	69
STEVENS, MICRO-SCISSORS, BAJONETT SHAPED HANDLE, STRAIGHT, SH/SH, 18,5 CM	59	TISSUE FORCEPS 2X3 TEETH STR 13,0 CM	69
STEVENS, MICRO-SCISSORS, BAJONETT SHAPED HANDLE, STRAIGHT, SH/SH, 22,5 CM	59	TISSUE FORCEPS 2X3 TEETH STR 14,5 CM	69
STEVENS, TENOTOMY SCS., SUPERCUT, CURVED, SH/SH, 11,0 CM	57	TISSUE FORCEPS 2X3 TEETH STR 16,0 CM	69
STEVENS, TENOTOMY SCS., SUPERCUT, STRAIGHT, SH/SH, 11,0 CM	57	TISSUE FORCEPS 2X3 TEETH STR 18,0 CM	69
STILLE DRESSING FORCEPS 15,0 CM	66	TISSUE FORCEPS 2X3 TEETH STR 20,0 CM	69
STILLE KIDNEY PED.CLAMP FCPS 23,0 CM	116	TISSUE FORCEPS 2X3 TEETH STR 25,0 CM	69
STILLE TISSUE FCPS 2X3 TEETH STR 15,0 CM	72	TISSUE FORCEPS 2X3 TEETH STR 30,0 CM	69
STILLE TISSUE FCPS STR 1X2 TEETH 15,0 CM	72	TISSUE FORCEPS 3X4 TEETH STR 13,0 CM	69
STILLE, CHISEL 10 MM, 20,0 CM	305	TISSUE FORCEPS 3X4 TEETH STR 14,5 CM	69
STILLE, CHISEL 12 MM, 20,0 CM	305	TISSUE FORCEPS 3X4 TEETH STR 16,0 CM	69
STILLE, CHISEL 15 MM, 20,0 CM	305	TISSUE FORCEPS 3X4 TEETH STR 18,0 CM	69
STILLE, CHISEL 25 MM 20,0 CM	305	TISSUE FORCEPS 3X4 TEETH STR 20,0 CM	69
STILLE, GOUGE 10 MM, 20,0 CM	305	TISSUE FORCEPS 3X4 TEETH STR 20,0 CM	69
STILLE, GOUGE 12 MM, 20,0 CM	305	TISSUE FORCEPS 4X5 TEETH STR 13,0 CM	69
STILLE, GOUGE 15 MM, 20,0 CM	305	TISSUE FORCEPS 4X5 TEETH STR 14,5 CM	69
STILLE, GOUGE 25 MM, 20,0 CM	305	TISSUE FORCEPS 4X5 TEETH STR 16,0 CM	69
STILLE, OSTEOTOME 15 MM, 20,0 CM	304	TISSUE FORCEPS 4X5 TEETH STR 18,0 CM	69
STILLE, OSTEOTOME 20 MM, 20,0 CM	304	TISSUE FORCEPS 4X5 TEETH STR 20,0 CM	69
STILLE, OSTEOTOME 25 MM, 20,0 CM	304	TISSUE FORCEPS NARROW 1X2 TEETH 14,5 CM	70
STILLE, OSTEOTOME, 10 MM, 20,0 CM	304	TISSUE FORCEPS NARROW 1X2 TEETH 15,5 CM	70
STOCKMANN MEATUS CLAMP W/O CATCH	240	TISSUE FORCEPS NARROW 1X2 TEETH 16,0 CM	70
STOPCOCK, 1 X LUER-LOCK MALE 2 X LUER-LOCK, FEMALE	229	TISSUE FORCEPS NARROW 1X2 TEETH 18,0 CM	70
STOPCOCK, LUER-LOCK, 1 X MALE, 1 X FEMALE	229	TISSUE FORCEPS NARROW 1X2 TEETH 20,0 CM	70
STOPCOCK, LUER-LOCK, FEMALE	229	TISSUE FORCEPS NARROW 1X2 TEETH 25,0 CM	70
STRABISMUS SCISSORS CVD BLUNT 11,5 CM	28	TISSUE FORCEPS NARROW 1X2 TEETH 30,0 CM	70
STRABISMUS SCISSORS CVD BLUNT 11,5 CM SC	57	TISSUE FORCEPS, ENGL. PATTERN, 1X2 T STR 13,0 CM	70
STRABISMUS SCISSORS STR BL, 11,5CM SC	57	TISSUE FORCEPS, ENGL. PATTERN, 1X2 T STR 14,5 CM	70
STRABISMUS SCISSORS STR BLUNT 11,5 CM	28	TISSUE FORCEPS, ENGL. PATTERN, 1X2 T STR 15,0 CM	70
STRATTE NEEDLE HOLDER 23,0 CM	128	TISSUE FORCEPS, NARROW STRAIGHT, 1X2 TEETH, 13,0 CM	70
STRATTE NEEDLE HOLDER TC CVD 22,0 CM	140	TISSUE FORCEPS, STANDARD, 1X2 TEEHT, STRAIGHT, 20,0 CM	69
STRATTE NEEDLE HOLDER TC CVD 23,0 CM	140	TISSUE FORCEPS, STANDARD, 1X2 TEETH, STRAIGHT, 18,0 CM	69
STRAUSS MEATUS CLAMP WITH RUBBER COVER	240	TISSUE FORCEPS, STANDARD, STRAIGHT, 1X2 TEETH, 16,0 CM	69
STRULLY NEUROSURGICAL SCS CVD 22,0 CM	34	TISSUE FORCEPS, STANDARD, 1X2 T STR 10,5 CM	69
SURGICAL SCISSORS, STANDARD WITH TUNGSTEN CARBIDE INSERTS STRAIGHT, BLUNT/BLUNT, 14,5 CM	46	TISSUE FORCEPS, STANDARD, 1X2 T STR 11,5 CM	69
SYRINGE, LUER, 1 ML	227	TISSUE FORCEPS, STANDARD, 1X2 T STR 13,0 CM	69
SYRINGE, LUER, 10 ML	227	TISSUE FORCEPS, STANDARD, 1X2 T STR 14,5 CM	69
SYRINGE, LUER, 2 ML	227	TISSUE FORCEPS, STANDARD, 1X2 T STR 15,0 CM	69
SYRINGE, LUER, 20 ML	227	TISSUE FORCEPS, STANDARD, 1X2 T STR 25,0 CM	69
SYRINGE, LUER, 30 ML	227	TISSUE FORCEPS, STANDARD, 1X2 T STR 30,0 CM	69
SYRINGE, LUER, 5 ML	227	TITAN BULLDOG CLAMPS, ARTERIA, 35MM, CVD	95
SYRINGE, LUER-LOCK, 1 ML	227	TITAN BULLDOG CLAMPS, ARTERIA, 35MM, STR	95
SYRINGE, LUER-LOCK, 10 ML	227	TITAN BULLDOG CLAMPS, ARTERIA, 40MM, CVD	95
SYRINGE, LUER-LOCK, 10 ML	228	TITAN BULLDOG CLAMPS, ARTERIA, 40MM, STR	95
SYRINGE, LUER-LOCK, 2 ML	227	TITAN BULLDOG CLAMPS, VENA, 35MM, CURVED	95
SYRINGE, LUER-LOCK, 20 ML	227	TITAN BULLDOG CLAMPS, VENA, 35MM, STR.	95
SYRINGE, LUER-LOCK, 20 ML	228	TITAN BULLDOG CLAMPS, VENA, 40MM, CURVED	95
SYRINGE, LUER-LOCK, 30 ML	228	TITAN BULLDOG CLAMPS, VENA, 40MM, STR.	95
SYRINGE, LUER-LOCK, 5 ML	227	TOENNIS ARTERY FORCEPS CVD 1X2 T 21,0 CM	111
SYRINGE, LUER-LOCK, 50 ML	227	TOENNIS ARTERY FORCEPS CVD 1X2 T 26,0CM	111
SYRINGE, LUER-LOCK, 50 ML	228	TOENNIS ARTERY FORCEPS CVD 21,0 CM	111
SYRINGE, THREERING-, LUER-LOCK, 10 ML	227	TOENNIS ARTERY FORCEPS CVD 26,0 CM	111
SYRINGE, THREERING-, LUER-LOCK, 2 ML	227	TOENNIS ARTERY FORCEPS STR 1X2 T, 21,0CM	111
SYRINGE, THREERING-, LUER-LOCK, 5 ML	227	TOENNIS ARTERY FORCEPS STR 1X2 T.,26,0CM	111
TAYLOR DRESSING FCPS BAY-SHAPED 17,5 CM	66	TOENNIS ARTERY FORCEPS STR 21,0 CM	111
TAYLOR DRESSING FORCEPS CVD 17,5 CM	66	TOENNIS ARTERY FORCEPS STR 26,0 CM	111
TAYLOR DRESSING FORCEPS STR 17,5 CM	66	TOENNIS DISS.SCISSORS CVD BL 18,0 CM	33
TAYLOR TISSUE FCPS BAY-SHAPED 17,5 CM	73	TOENNIS DISS.SCISSORS STR 18,0 CM	32
TAYLOR TISSUE FCPS CVD 1X2 TEETH 17,5 CM	73	TOENNIS NEEDLE HOLDER 18,0 CM	128
TAYLOR TISSUE FCPS STR 1X2 TEETH 17,5 CM	73	TOENNIS, NEEDLE HOLDER WITH TC, 18,0 CM	140
TEALE FCPS CVD 3X4 T. 23,0 CM	274	TOENNIS-ADSON DISS.SCS CVD 17,5 CM	24
TENOTOMY SCISSORS CVD BLUNT 11,5 CM	31	TOENNIS-ADSON SCS DELI TC CVD 17,5 CM	50
TERRIER, ARTERY FORCEPS STRAIGHT, 1X2 TEETH, 10,0 CM	98	TOENNIS-ADSON, DISSEC.-SCS. SUPERCUT, CURVED, BL/BL, 17,5 CM	56
THOMS-ALLIS INT.TISSUE FCPS. 6X7 20,0 CM	243	TOHOKU-JAPAN TOWEL FORCEPS	88
THOMS-GAYLOR, CERVICAL BIOPSY FORCEPS, 24,0 CM	286	TOHOKU-JAPAN TOWEL FORCEPS	88
THOMS-GAYLOR, CERVICAL BIOPSY FORCEPS, 24,0 CM	287	TOWEL FCPS WITH CLIP FOR TUBING 11,0 CM	86
THOMSON-WALKER, BLADDER RETRACTOR	237	TOWEL FCPS., FOR PAPER CLOTHS, 13,5 CM	87
THOREK, DISSECTING SCISSORS, CURVED, 19,0 CM	27	TRELAT LIGATURE NEEDLE 23,0 CM	150
		TREVES, TISSUE FCPS., 1X2 TEETH, 13,0 CM	76
		TREVES, TISSUE FCPS., 1X2 TEETH, 15,0 CM	76
		TUBERCULINE SYRINGE, LUER-LOCK, 1 ML	228
		TUBING CLAMP 15,5 CM	91
		TUBING CLAMP 15,5 CM WITH CLIP	91
		TUBING CLAMP 18,0 CM	91
		TUBING CLAMP 20,0 CM	91
		TUBING CLAMP 20,0 CM WITH CLIP	91
		TUFFIER ABDOMINAL SPATULA 20,0 CM	210
		TUFFIER ARTERY FORCEPS 5X4 TEETH 13,0 CM	96
		TUFFIER RIB SPREADER 50X45MM/165MM	211
		TUOHY NEEDLE,76 MM X 16 G	226
		TUOHY NEEDLE,76 MM X 17 G	226
		TUOHY NEEDLE,76 MM X 18 G	226

TURNER-WARWICK MODIF., ABDOMINAL RETRACTOR, FRAME ONLY, 455 x 330 MM 203	VOLKMANN RETR.SHARP 2 PRONGS 21.5 CM	170
TURNER-WARWICK MODIF., ABDOMINAL RETRACTOR, FRAME ONLY, Ø 180 MM	VOLKMANN RETR.SHARP 3 PRONGS 21.5 CM	170
203	VOLKMANN RETR.SHARP 4 PRONGS 21.5 CM	170
TURNER-WARWICK MODIF., ABDOMINAL RETRACTOR, FRAME ONLY, Ø 230 MM	VOLKMANN RETR.SHARP 6 PRONGS 21.5 CM	170
203	VOLKMANN, BONE CURETTE OVAL/OVAL, 13.0 CM	300
TURNER-WARWICK MODIF., ABDOMINAL RETRACTOR, VALVES ONLY, 114X60 MM	VOLKMANN, BONE CURETTE OVAL/OVAL, 14.0 CM	300
204	VOLKMANN, BONE CURETTE, OVAL/OVAL, 17.0 CM	300
TURNER-WARWICK MODIF., ABDOMINAL RETRACTOR, VALVES ONLY, 13 MM	VOLKMANN, RETRACTOR SEMI-SHARP 1 PRONG, 21.5 CM	170
204	VOLKMANN, RETRACTOR, 8 PRONGS, SEMI-SHARP, 21.5 CM	170
TURNER-WARWICK MODIF., ABDOMINAL RETRACTOR, VALVES ONLY, 19X76 MM	VOLKMANN, RETRACTOR, 8 PRONGS, BLUNT, 21.5 CM	171
204	VOLKMANN, RETRACTOR, 8 PRONGS, SHARP, 21.5 CM	170
TURNER-WARWICK MODIF., ABDOMINAL RETRACTOR, VALVES ONLY, 38X102 MM, WITHOUT SLIDING PART, STAINLESS FINISH	WACHENFELDT SUTURE FORCEPS 12.5 CM	154
204	WAGNER FINE SCISSORS CVD BL/BL 12.0 CM	28
TURNER-WARWICK MODIF., ABDOMINAL RETRACTOR, VALVES ONLY, 57X114 MM	WAGNER FINE SCISSORS CVD SH/SH 12.0 CM	28
204	WAGNER FINE SCISSORS STR BL/BL 12.0 CM	28
TURNER-WARWICK MODIF., ABDOMINAL RETRACTOR, VALVES ONLY, 57X89 MM WITHOUT SLIDING PART, STAINLESS FINISH	WAGNER FINE SCISSORS STR SH/SH 12.0 CM	28
204	WALB, BRAIN KNIFE, BLADE 11.0 CM	9
TURNER-WARWICK MODIF., ABDOMINAL RETRACTOR, VALVES ONLY, 76X60 MM, WITHOUT SLIDING PART, STAINLESS FINISH	WALB, BRAIN KNIFE, BLADE 14.0 CM	9
204	WALB, BRAIN KNIFE, BLADE 17.0 CM	9
TURNER-WARWICK MODIF., ABDOMINAL RETRACTOR, VALVES ONLY, 89X60 MM	WALDMANN EPISIOTOMY SCS SAW EDGE 18.0 CM	43
204	WALLICH OVUM SCOOPS, 42.0CM	292
TURNER-WARWICK, GALL STONE FORCEPS, FIG. 1, 18,0 CM	WALTER-CARMALT SPLINTER FCPS CVD 10.5 CM	78
233	WALTER-CARMALT SPLINTER FCPS STR 10.5 CM	78
TURNER-WARWICK, GALL STONE FORCEPS, FIG. 3, 17,5 CM	WANGENSTEEN NEEDLE HOLDER 27.0 CM	127
233	WANGENSTEEN TISSUE FORCEPS TC 15.0 CM	82
UCKERMANN COTTON APPLICATOR 15 CM W.HOLE	WANGENSTEEN TISSUE FORCEPS TC 23.0 CM	82
216	WANGENSTEEN, NEEDLE HOLDER WITH TC, 27.0 CM	138
ULRICH POLYPUS FORCEPS CURVED 22.0 CM	WANGENSTEEN, TISSUE FORCEPS, TC, 25.0 CM	82
89	WATSON-CHEYNE, DISSECTOR, 17,5 CM	301
ULRICH POLYPUS FORCEPS CURVED 25.0 CM	WAUGH, DRESSING FORCEPS, 15.0 CM	68
89	WAUGH, DRESSING FORCEPS, 20.0 CM	68
ULRICH POLYPUS FORCEPS CURVED 27.0 CM	WAUGH, TISSUE FCPS., 1X2 T, SERRATED, 15.0 CM	74
89	WAUGH, TISSUE FCPS., 1X2 T, SERRATED, 20.0 CM	74
ULRICH POLYPUS FORCEPS STRAIGHT 22.0 CM	WEBSTER NEEDLE HOLDER SMOOTH JAWS 13.0CM	124
89	WEBSTER NEEDLE HOLDER TC 13.0 CM	133
ULRICH POLYPUS FORCEPS STRAIGHT 25.0 CM	WEBSTER NEEDLE HOLDER TC, SMOOTH, 13.0 CM	133
89	WEISSBARTH, VAGINAL SPECULA, W. REMOVABLE WIRE BASKET	260
ULRICH POLYPUS FORCEPS STRAIGHT 27.0 CM	WEITLANER RETRACTOR BLUNT 13.0 CM	191
89	WEITLANER RETRACTOR BLUNT 16.5 CM	191
UNIVERSAL BANDAGE SCISSORS 14.0 CM	WEITLANER RETRACTOR BLUNT 20.0 CM	191
45	WEITLANER RETRACTOR SHARP 13.0 CM	191
UNIVERSAL BANDAGE SCISSORS 16.0 CM	WEITLANER RETRACTOR SHARP 16.5 CM	191
45	WEITLANER RETRACTOR SHARP 20.0 CM	191
UNIVERSAL BANDAGE SCISSORS 18.0 CM	WEITLANER-BABY RETRACTOR 13.0 CM	193
45	WEITLANER-LOKTITE, RETRACTOR SELF-RETAINING, BLUNT 2X3 TEETH, 10.5 CM	191
UNIVERSAL TROCARS SET OF 3 FLAT HDL.	WEITLANER-LOKTITE, RETRACTOR SELF-RETAINING, SHARP 2X3 TEETH, 10.5 CM	191
218	WERTHEIM CLAMP-FCPS EXTRA STRONG 24,0CM	119
UNIVERSAL TROCARS SET OF 4 FLAT HDL.	WERTHEIM CLAMP-FORCEPS 25.0 CM	119
218	WERTHEIM OPER.SCISSORS CVD BL/BL 19.5 CM	41
UNIVERSAL TROCARS, SET OF 3 PCS., ROUND HANDLE	WERTHEIM OPER.SCISSORS CVD BL/BL 22.5 CM	41
219	WERTHEIM, VAGINAL SPECULA, 95X38MM	268
UNIVERSAL TROCARS, SET OF 4 PCS., ROUND HANDLE	WERTHEIM-CULLEN CLAMP-FORCEPS 21.5 CM	120
219	WESTCOTT TENOTOMY SCISSORS BLUNT 11.0 CM	59
UNIVERSAL WIRE SCISSORS SAW EDGE 12.0 CM	WESTCOTT TENOTOMY SCS.POINTEED 11.0 CM	59
44	WIKSTROEM DISS.AND LIG.FCPS.CVD 19.0 CM	112
UNIVERSAL WIRE SHEARS TC 12.0 CM	WIKSTROEM DISS.AND LIG.FCPS.CVD 21.0 CM	112
55	WIKSTROEM DISS.AND LIG.FCPS.CVD 24.0 CM	112
UNNA, COMEDO EXTRACTOR, Ø OVAL, 14,0 CM	WILLAUER, LOBECTOMY AND RECTAL SCS., STRAIGHT, BL/BL, 25.0 CM	42
295	WILLAUER, LOBECTOMY AND RECTAL SCS., STRAIGHT, BL/BL, 25.0 CM	42
UNNA, COMEDO EXTRACTOR, Ø ROUND, 14,0 CM	WILLAUER, LOBECTOMY AND RECTAL SCS., STRAIGHT, BL/BL, 28.0 CM	42
295	WILLAUER, LOBECTOMY AND RECTAL SCS., STRAIGHT, BL/BL, 28.0 CM	42
URO-TANGENTIAL FORCEPS 26CM	WILLET-MARTEL SCALP FLAP FORCEPS 19.0 CM	97
117	WILLIAMS, INTESTINAL GRASPING FORCEPS, 16,0 CM	244
URO-TANGENTIAL FORCEPS 26CM	WILLIGER ELEVATOR 16.0 CM	301
117	WILLIGER ELEVATOR 17.0 CM	301
UTERINE CURETTE BLUNT MALLE 26 CM 21 MM	WILLIGER, BONE CURETTE FIG.00/0, 14.0 CM	300
281	WILLIGER, BONE CURETTE FIG.1/2, 14.0 CM	300
UTERINE CURETTE BLUNT MALLE 26 CM 23 MM	WILLIGER, BONE CURETTE, FIG.0/1, 14.0 CM	300
281	WILLIGER, PERIOSTEAL RASPARTORY, 8 MM, 16,0 CM	303
UTERINE CURETTE BLUNT MALLE 31 CM 21 MM	WILLIGER, PERIOSTEAL RASPARTORY, 4 MM, 16,0 CM	303
283	WILLIGER, PERIOSTEAL RASPARTORY, 6 MM, 16,0 CM	303
UTERINE CURETTE BLUNT MALLE 31 CM 23 MM	WILLIGER, SHARP SPOON FIG. 2, OVAL, 17,0 CM	300
283	WILLIGER, SHARP SPOON FIG.1, OVAL, 17,0 CM	300
UTERINE CURETTE BLUNT RIGID 26 CM 21 MM	WINTER OVUM FORCEPS, FIG.3,STR.,28.0CM	291
281	WINTER OVUM FORCEPS, STRAIGHT, 27.0CM	291
UTERINE CURETTE BLUNT RIGID 26 CM 23 MM	WINTER OVUM FORCEPS,FIG.1,CURVED 28.0CM	291
281	WINTER OVUM FORCEPS,FIG.1,STR.,28.0CM	291
UTERINE CURETTE BLUNT RIGID 31 CM 21 MM	WINTER OVUM FORCEPS,FIG.2,CURVED 28.0CM	291
283	WINTER OVUM FORCEPS,FIG.2,STR.,28.0CM	291
UTERINE CURETTE BLUNT RIGID 31 CM 23 MM	WINTER OVUM FORCEPS,FIG.3,CURVED,28.0CM	291
283	WIRE TWISTING FORCEPS, WITH TC-INSERTS, 20.0 CM	139
UTERINE CURETTE SH.MALLE 31 CM 21 MM	WITTNER BIOPSY FORCEPS CURVED 23.0 CM	287
282	WITTNER BIOPSY FORCEPS STRAIGHT 23.0 CM	287
UTERINE CURETTE SH.MALLE 31 CM 23 MM	WRIGLEY, OBSTETRICAL FORCEPS, 28.0CM	289
282	WULLSTEIN, SELF-RETAINING RETRACTOR, BLUNT, 3X3 PRONGS, 10,5 CM	190
UTERINE CURETTE SHARP MALLE 26 CM 21 MM	WULLSTEIN, SELF-RETAINING RETRACTOR, BLUNT, 3X3 PRONGS, 13,5 CM	190
280	WULLSTEIN, SELF-RETAINING RETRACTOR, BLUNT, 3X3 PRONGS, 15,0 CM	190
UTERINE CURETTE SHARP MALLE 26 CM 23 MM	WULLSTEIN, SELF-RETAINING RETRACTOR, BLUNT, 3X3 PRONGS, 18,0 CM	190
280		
UTERINE PERFORATOR, MOD. ERLANGEN MODIF., Ø 2,5 MM, 25,0 CM		
279		
UTERUS CURETTE SHARP RIGID 31 CM 21 MM		
282		
UTERUS CURETTE SHARP RIGID 31 CM 23 MM		
282		
VALLEIX UTERINE PROBE W.SLIDE 25.0 CM		
277		
VERRES NEEDLE 2.0X100 MM		
225		
VERRES NEEDLE 2.0X150 MM		
225		
VERRES TUBES 2,0 X 120MM		
225		
VESSEL DILATOR Ø 0.3 MM, BLUNT, 12.5 CM		
81		
VESSEL DILATOR Ø 0.3 MM, BLUNT, 13.5 CM		
81		
VESSEL DILATORS CURVED, Ø 0.4 MM, 12.0 CM		
81		
VESSEL DILATORS, 0,3 MM, 11.0 CM		
80		
VESSEL DILATORS, 0,3 MM, 45° ANGLED, 11,0 CM		
80		
VESSEL DILATORS, 0,3 MM, 45° ANGLED, 13,5 CM		
81		
VESSEL DILATORS, 0,3 MM, 90° ANGLED, 11,0 CM		
80		
VESSEL DILATORS, DIAMOND COATED, 0,3 MM, 45° ANGLED, 11,0 CM		
80		
VIRCHOW, BRAIN KNIFE, BLADE 16.0 CM		
9		
VIRCHOW, BRAIN KNIFE, BLADE 20.0 CM		
9		
VIRCHOW, BRAIN KNIFE, BLADE 24.0 CM		
9		
VOLKMANN BONE CURETTE, FIG.00		
298		
VOLKMANN BONE CURETTE, FIG.000		
298		
VOLKMANN BONE CURETTE, FIG.0000		
298		
VOLKMANN BONE CURETTE, FIG.1		
298		
VOLKMANN BONE CURETTE, FIG.2		
298		
VOLKMANN BONE CURETTE, FIG.3		
298		
VOLKMANN BONE CURETTE, FIG.4		
298		
VOLKMANN BONE CURETTE, FIG.5		
298		
VOLKMANN BONE CURETTE, FIG.6		
298		
VOLKMANN CURETTE FIG.0		
298		
VOLKMANN RETR.BLUNT 1 PRONG 21.5 CM		
171		
VOLKMANN RETR.BLUNT 2 PRONGS 21.5 CM		
171		
VOLKMANN RETR.BLUNT 3 PRONGS 21.5 CM		
171		
VOLKMANN RETR.BLUNT 4 PRONGS 21.5 CM		
171		
VOLKMANN RETR.BLUNT 6 PRONGS 21.5 CM		
171		
VOLKMANN RETR.SEMI-SHARP 2 PRONGS 21.5CM		
170		
VOLKMANN RETR.SEMI-SHARP 3 PRONGS 21.5CM		
170		
VOLKMANN RETR.SEMI-SHARP 4 PRONGS 21.5CM		
170		
VOLKMANN RETR.SEMI-SHARP 6 PRONGS 21.5CM		
170		
VOLKMANN RETR.SHARP 1 PRONG 21.5 CM		
170		

WULLSTEIN, SELF-RETAINING RETRACTOR, SHARP, 3X3 PRONGS, 15,0 CM	190
WULLSTEIN, SELF-RETAINING RETRACTOR, SHARP, 3X3 PRONGS, 18,0 CM	190
WULLSTEIN, SELF-RETAINING RETRACTOR, SHARP, 3X3PRONGS, 10,5 CM	190
WULLSTEIN, SELF-RETAINING RETRACTOR, SHARP, 3X3PRONGS, 13,0 CM	190
YANKAUER, SUCTION TUBE, CENTRAL HOLE Ø 2.0 MM, OUTER DIAM. 6.0MM	28.5 CM
222	
YEOMAN RECTAL BIOPSY FCPS FIG.1 28.0 CM	255
YEOMAN RECTAL BIOPSY FCPS FIG.1 35.0 CM	255
YEOMAN RECTAL BIOPSY FCPS FIG.1 42.0 CM	255
YEOMAN RECTAL BIOPSY FCPS FIG.2 28.0 CM	255
YEOMAN RECTAL BIOPSY FCPS FIG.2 35.0 CM	255
YEOMAN RECTAL BIOPSY FCPS FIG.2 42.0 CM	255
YEOMAN RECTAL BIOPSY FCPS FIG.3 28.0 CM	255
YEOMAN RECTAL BIOPSY FCPS FIG.3 35.0 CM	255
YEOMAN RECTAL BIOPSY FCPS FIG.3 42.0 CM	255
YEOMAN RECTAL BIOPSY FCPS FIG.4 28.0 CM	255
YEOMAN RECTAL BIOPSY FCPS FIG.4 35.0 CM	255
YEOMAN RECTAL BIOPSY FCPS FIG.4 42.0 CM	255
YOUNG PROSTATIC RETRACTOR 21CM	239
YOUNG PROSTATIC RETRACTOR 21CM	239
YOUNG PROSTATIC RETRACTOR 22CM	239
YOUNG PROSTATIC RETRACTOR 22CM	239
ZENKER DISS.FCPS SLIGHTLY CVD 29.5 CM	113
ZENKER DISS.FCPS STRONGLY CVD 29.5 CM	113
ZENKER RETRACTOR 35X8 MM 26.0 CM	182
ZENKER RETRACTOR 60X12 MM 26.0 CM	182
ZENKER RETRACTOR 75X12 MM 26.0 CM	182
ZWEIFEL NEEDLE HOLDER TC 20.0 CM	143
ZWEIFEL NEEDLE HOLDER TC 23.0 CM	143



Office: Defence road , sardarpura
Sialkot 51310 Pakistan
Phone: +92 334 1116870
Email: info@exaktmfgco.com